

Foreword

E09200108319

Thank you for selecting a MITSUBISHI MOTORS product as your new vehicle.

This owner's manual will add to your understanding and full enjoyment of the many fine features of this vehicle.

It contains information prepared to acquaint you with the proper way to operate and maintain your vehicle for the utmost in driving pleasure.

MITSUBISHI MOTORS CORPORATION reserves the right to make changes in design and specifications and/or to make additions to or improvements in this product without obligation to install them on products previously manufactured.

It is an absolute requirement for the driver to strictly observe all laws and regulations concerning vehicles.

This owner's manual has been written in compliance with such laws and regulations, but some of the contents may become contradictory with later amendment of the laws and regulations.

Please leave this owner's manual in this vehicle at time of resale. The next owner will appreciate having access to the information contained in this owner's manual.



Throughout this owner's manual the words **WARNING** and **CAUTION** appear. These serve as reminders to be especially careful. Failure to follow instructions could result in personal injury or damage to your vehicle.

WARNING

Indicates a strong possibility of severe personal injury or death if instructions are not followed.

CAUTION

Means hazards or unsafe practices that could cause minor personal injury or damage to your vehicle.

You will see another important symbol:

NOTE

Gives helpful information.

***: Indicates optional equipment.**

It may differ according to the sales classification; refer to the sales catalogue.

Abbreviations used in this owner's manual:

M/T: Manual Transmission

A/T: Automatic Transmission

CVT: Continuously Variable Transmission

The symbol used on the vehicles:

: See owner's manual

Table of contents

Overview/Quick guide	1
General information	2
Locking and unlocking	3
Seat and seat belts	4
Instruments and controls	5
Starting and driving	6
For pleasant driving	7
For emergencies	8
Vehicle care	9
Maintenance	10
Specifications	11
Alphabetical index	12



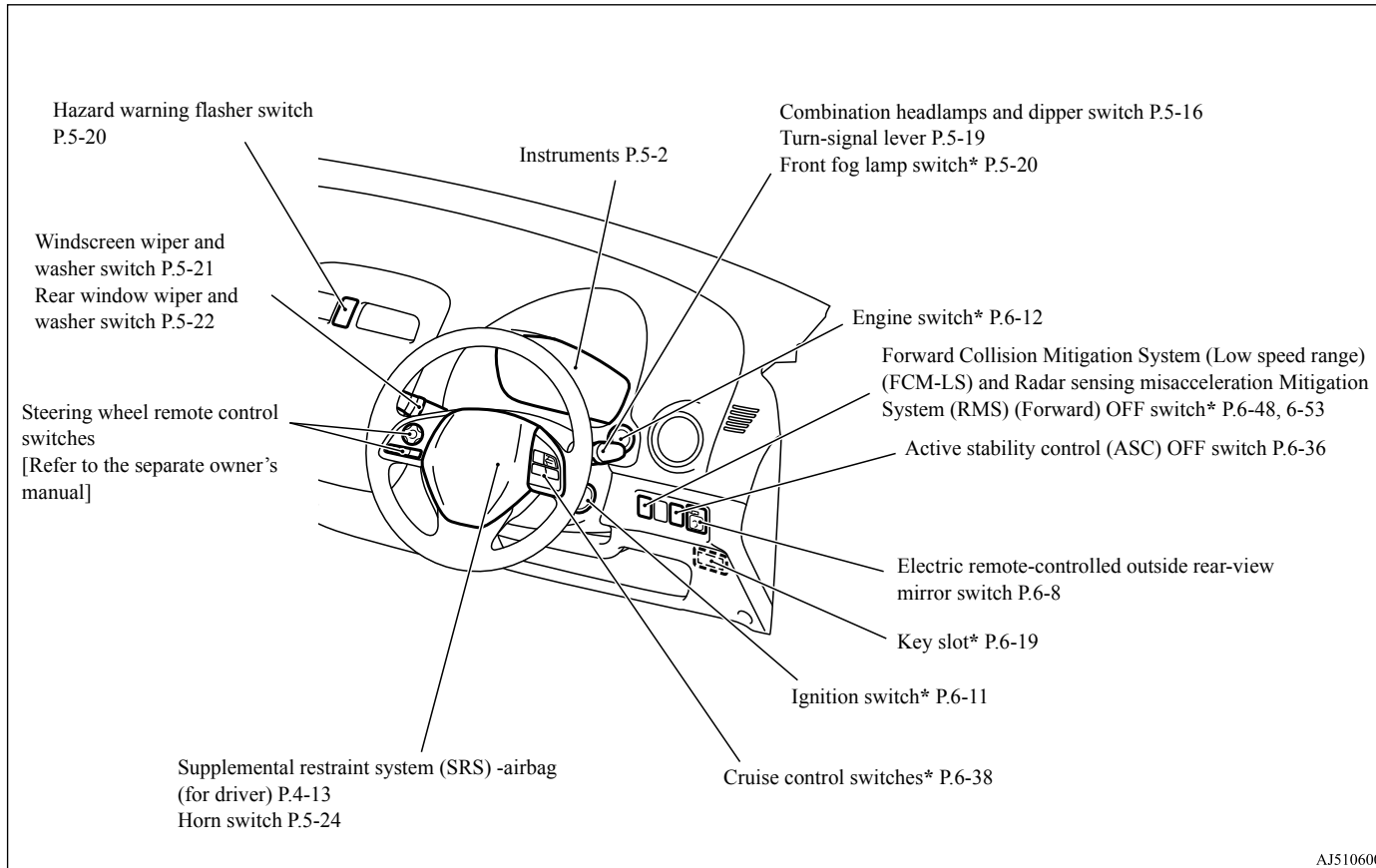
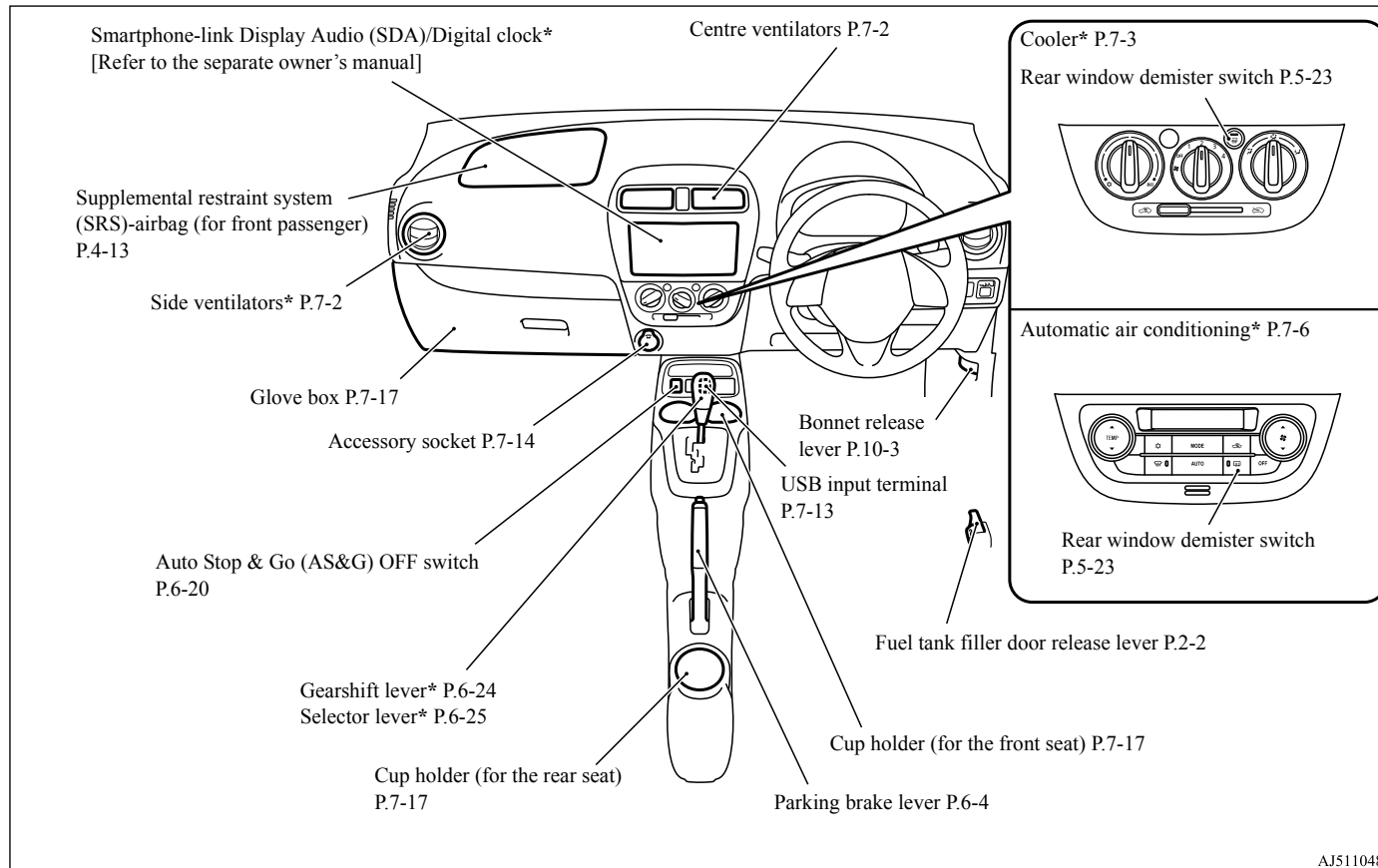

1 Interior

E08500202503

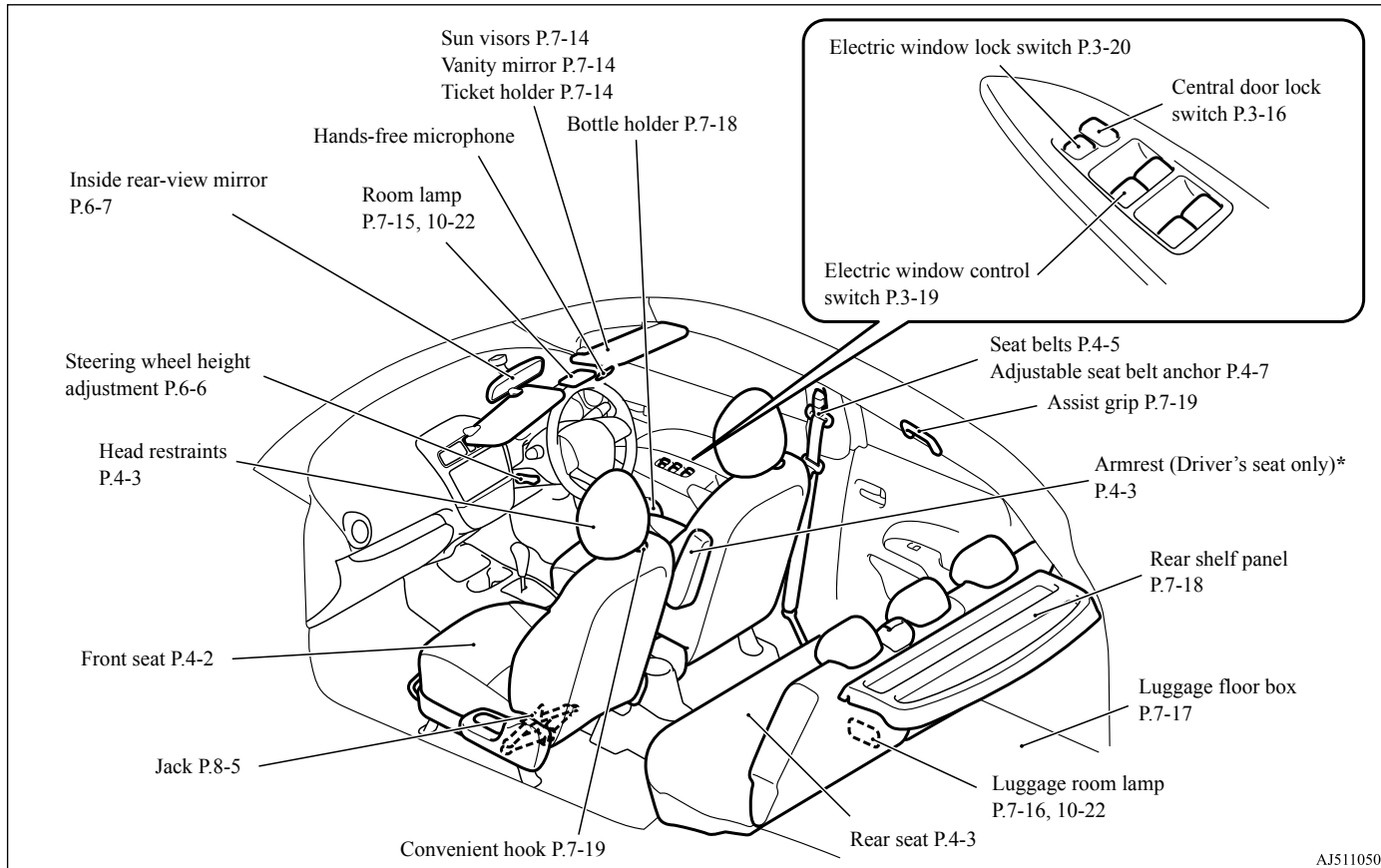

AJ5110509

Luggage area

1

E08500301637

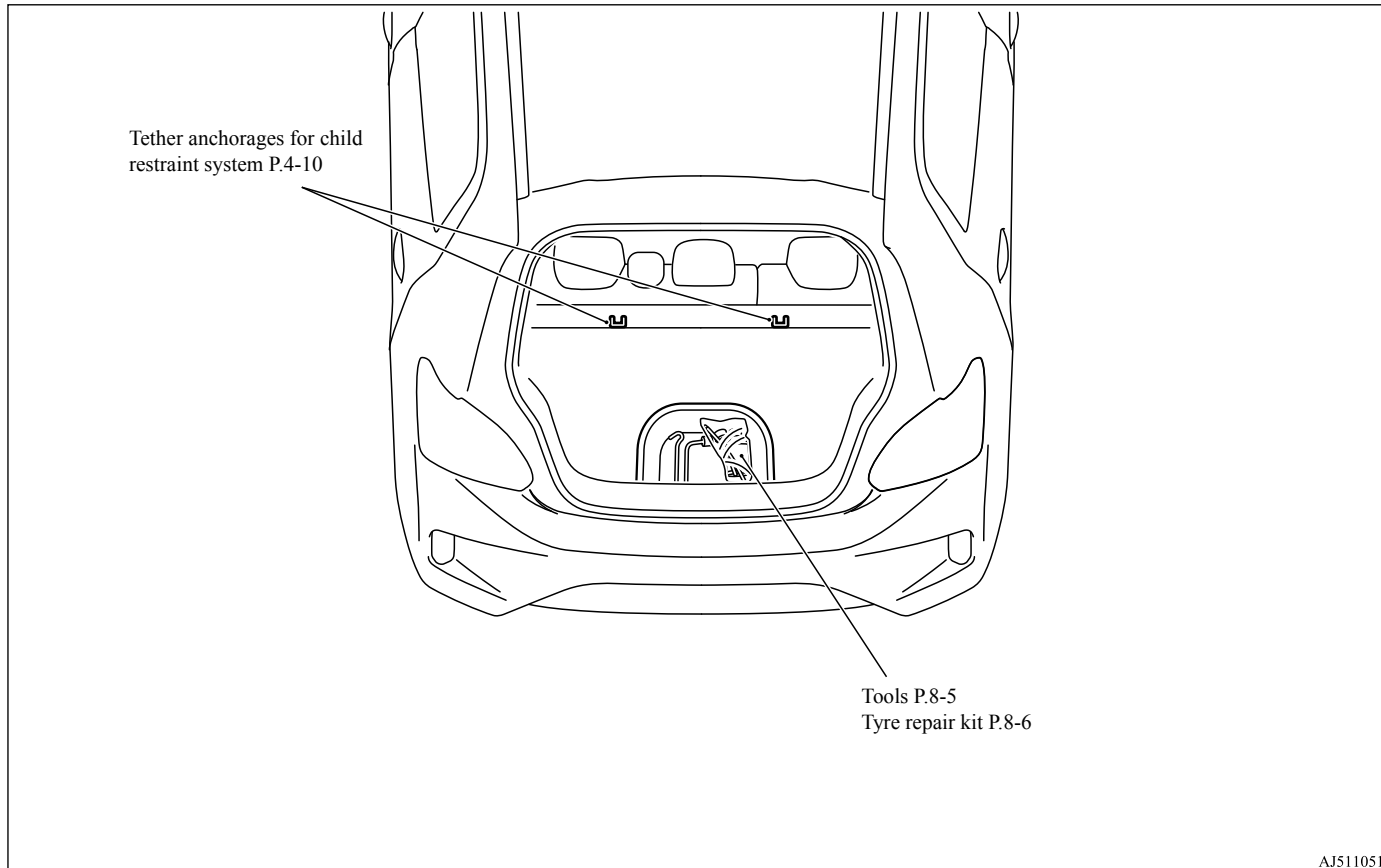

1 Exterior

E08500403632

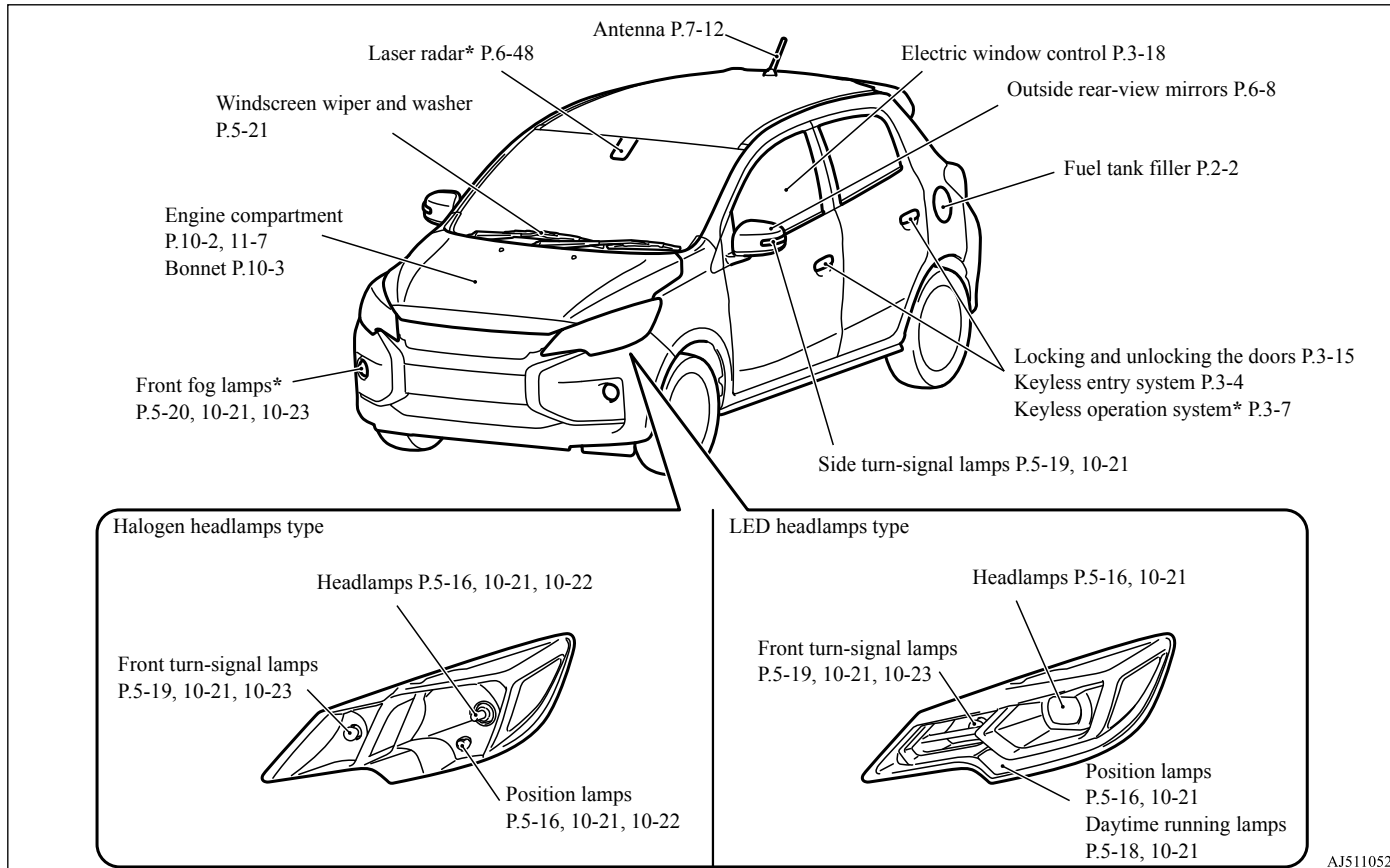

AJ5110525

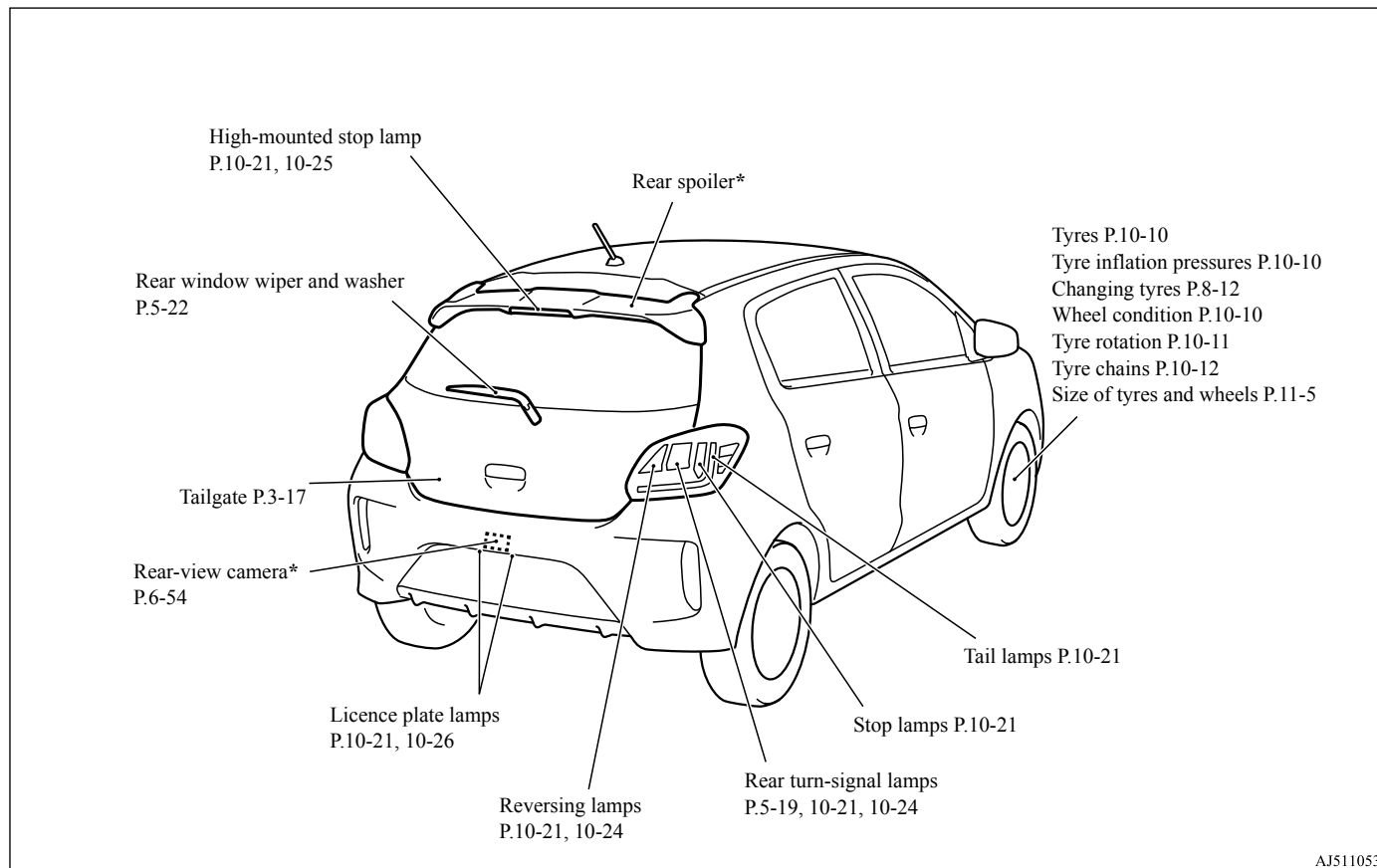

E08500500010

Lock and unlock the doors and tailgate

E08500602204

Keyless entry system

Press the remote control switch, and all doors and the tailgate will be locked or unlocked as desired.

The remote control switch will operate within approximately 4 m from the vehicle.

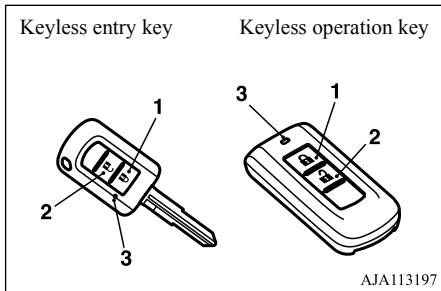

- 1- LOCK switch
- 2- UNLOCK switch
- 3- Indicator lamp

Refer to “Keyless entry system” on page 3-4.

Keyless operation system*

When you are carrying the keyless operation key, if you press the driver’s door lock/unlock switch (A), or the tailgate lock/unlock switch (B) within the operating range, the doors and the tailgate are locked/unlocked.

The operating range is approximately 70 cm from the driver’s door lock/unlock switch and the tailgate lock/unlock switch.

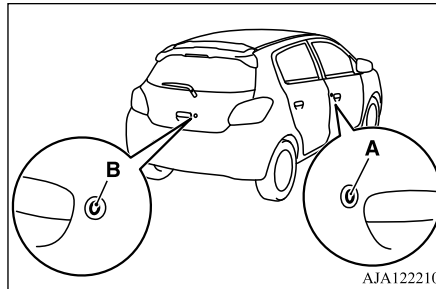

Refer to “keyless operation system” on page 3-7.

Around the driver’s seat

E08500802310

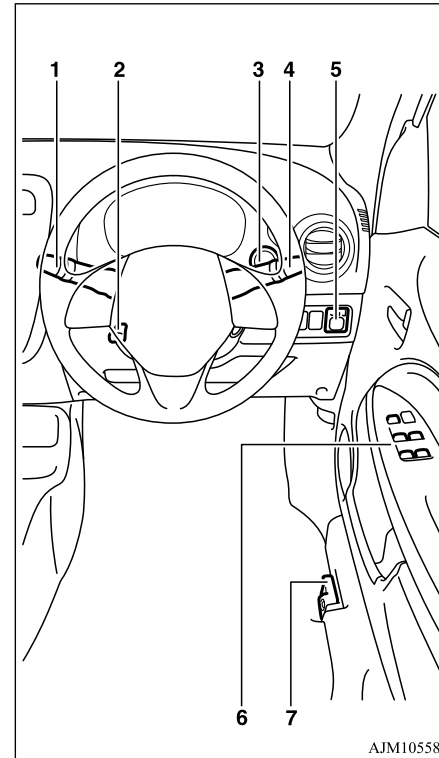

1-Wiper and washer switch

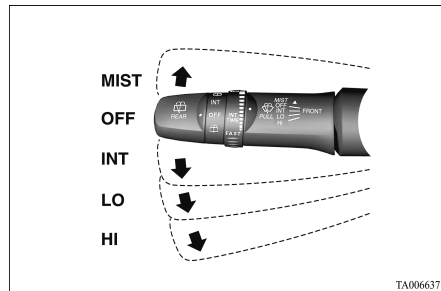

- MIST- Misting function
The wipers will operate once.
- OFF- Off
- INT- Intermittent (Speed sensitive)
- LO- Slow
- HI- Fast

The washer fluid will be sprayed onto the windscreen by pulling the lever towards you. Refer “Wiper and washer switch” on page 5-21.

2-Steering wheel height adjustment

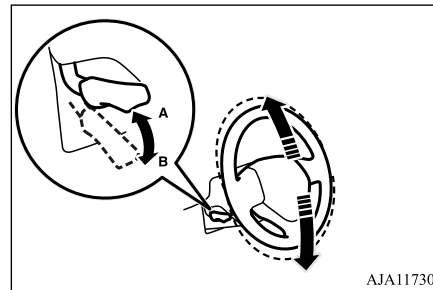

1. Release the lever while holding the steering wheel up.
2. Adjust the steering wheel to the desired position.
3. Securely lock the steering wheel by pulling the lever fully upward.

Refer “Steering wheel height adjustment” on page 6-6.

3-Engine switch*

If you are carrying the keyless operation key, you can start the engine. If you press the engine switch without depressing the brake pedal, you can change the operation mode in the order of OFF, ACC, ON, OFF.

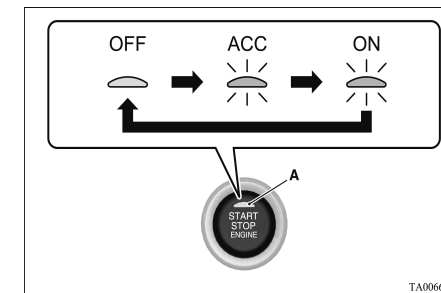

- OFF- The indicator lamp (A) on the engine switch turns off.
- ACC- The indicator lamp on the engine switch illuminates orange.
- ON- The indicator lamp on the engine switch illuminates green.

Refer “Engine switch” on page 6-12.

1 4-Combination headlamps

Rotate the switch to turn on the lamps.

■ Type 1

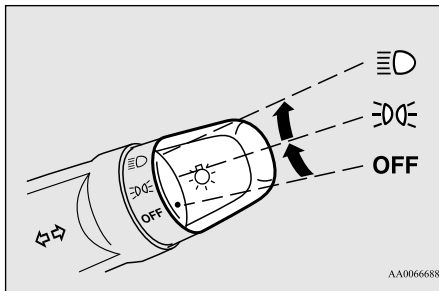

■ Type 2

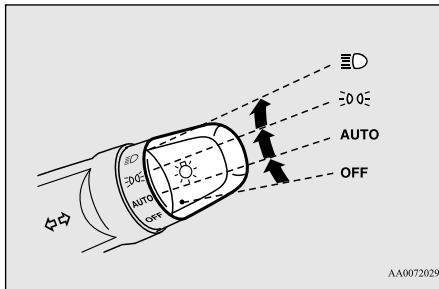

OFF	All lamps off {except for daytime-running lamps (if so equipped)}
AUTO	(Type 2 only) With the ignition switch or the operation mode is in ON, headlamps, position, tail, licence plate, and instrument panel lamps turn on and off automatically in accordance with outside light level. {Daytime running lamps (if so equipped) will go on while the tail lamps are off.} All lamps turn off automatically when the ignition switch is turned to "OFF" position or the operation mode is put in OFF.
	Position, tail, licence plate and instrument panel lamps on
	Headlamps and other lamps go on

Refer "Combination headlamps and dipper switch" on page 5-16.

4-Turn-signal lever

The turn-signal lamps flash when the lever is operated (with the ignition switch or the operation mode is in ON).

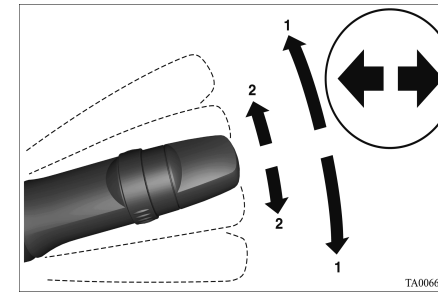

- 1- Turn-signals
- 2- Lane-change signals

Refer "Turn-signal lever" on page 5-19.

5-Electric remote-controlled outside rear-view mirrors

To adjust the mirror position

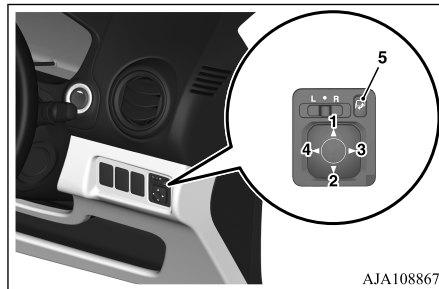

AJA108867

- L- Left outside mirror adjustment
- R- Right outside mirror adjustment
- 1- Up
- 2- Down
- 3- Right
- 4- Left
- 5- Mirror retractor switch

Refer “Electric remote-controlled outside rear-view mirrors” on page 6-8.

6-Electric window control

Press the switch down for opening the window, and pull the switch for closing.

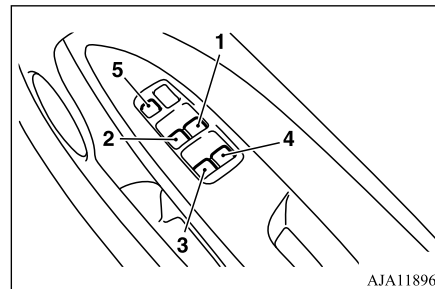

AJA118961

- 1- Driver's door window
- 2- Front passenger's door window
- 3- Rear left door window
- 4- Rear right door window
- 5- Lock switch

Lock switch

If you press the switch (5), the passenger's switches cannot be operated. To cancel, press it once again.

Refer “Electric window control” on page 3-18.

7-Fuel tank filler door release lever

Open the fuel tank filler door. The fuel tank filler is located on the rear left side of your vehicle.

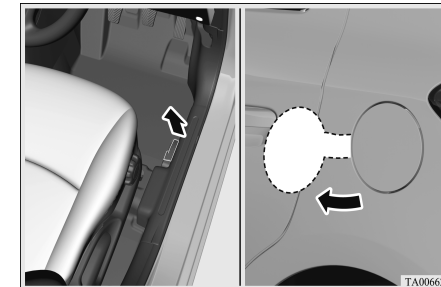

TA006296

Refer “Filling the fuel tank” on page 2-2.

1 Automatic transmission INVECS-III CVT (Intelligent & Innovative Vehicle Electronic Control System III)*

E08501001253

Selector lever operation

The CVT selects an optimum gear ratio automatically, depending on the speed of the vehicle and the position of the accelerator pedal.

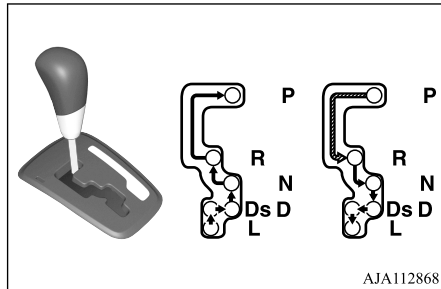

⬇	While depressing the brake pedal, move the selector lever through the gate.
⬇	Move the selector lever through the gate.

Selector lever positions

“P” PARK

This position locks the transmission to prevent the vehicle from moving. The engine can be started in this position.

“R” REVERSE

This position is to back up.

“N” NEUTRAL

At this position the transmission is disengaged.

“D” DRIVE

This position is for normal driving.

“Ds” DOWNSHIFT & SPORTY DRIVING

Use when engine braking is needed, or for high-power sport drive.

“L” LOW

This position is for driving up very steep hills and for engine braking at low speeds when driving down steep hills.

Refer to “Automatic transmission INVECS-III CVT (Intelligent & Innovative Vehicle Electronic Control System III)” on page 6-25.

Instruments

E08501101267

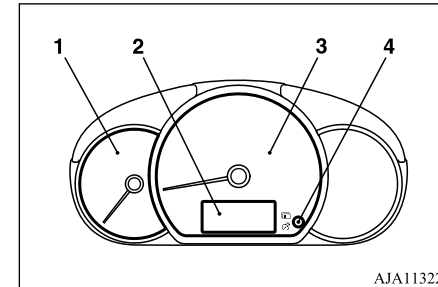

- 1- Tachometer
- 2- Multi-information display
- 3- Speedometer
- 4- Multi-information display switch

Refer to “Instruments” on page 5-2.

Multi-information display

Each time you lightly press the multi-information display switch, the information display switches odometer, tripmeter, meter illumination control, service reminder, fuel remaining, selector lever position, driving range, average fuel consumption, etc.

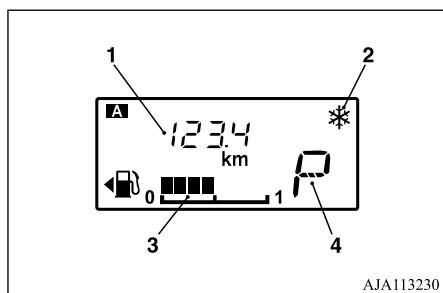

- 1- Information display
- 2- Frozen road warning → P.5-6
- 3- Fuel remaining display
- 4- Selector lever position display*

Refer to “Multi-information display” on page 5-2.

1 Indicator and warning lamps

E08501301298

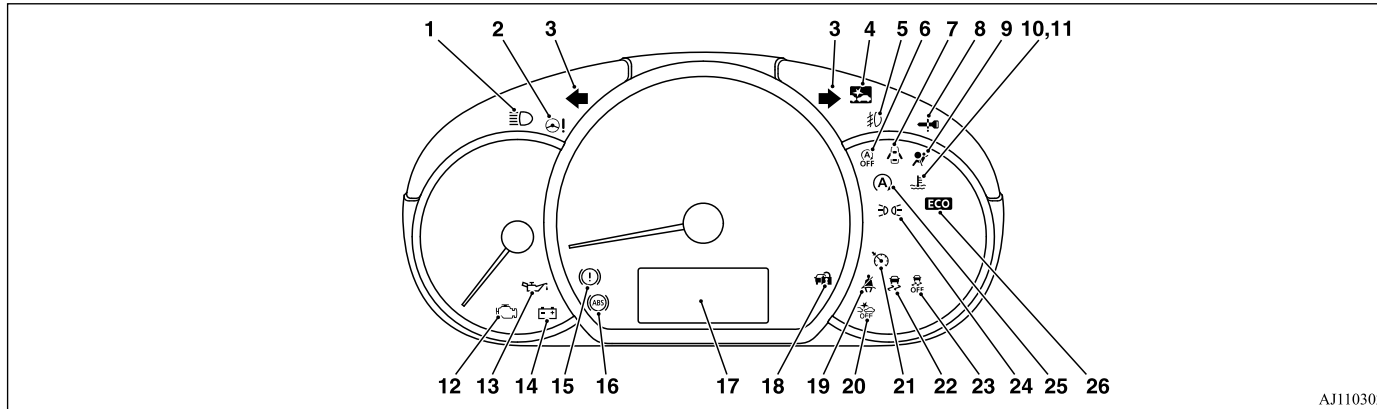

AJ1103020

- 1- High-beam indicator lamp → P.5-12
- 2- Electric power steering system (EPS) warning lamp → P.6-35
- 3- Turn-signal indicator lamps/Hazard warning indicator lamps → P.5-12
- 4- Forward Collision Mitigation System (Low speed range) (FCM-LS) and Radar sensing misacceleration Mitigation System (RMS) (Forward) indicator lamp* → P. 6-42, 6-49, 6-51
- 5- Front fog lamp indicator lamp* → P.5-12
- 6- Auto Stop & Go (AS&G) OFF indicator lamp → P.6-20

- 7- Door-ajar warning lamp → P.5-15
- 8- For details, refer to “Warning activator” on page 3-11. (if so equipped)
- 9- Supplemental restraint system (SRS) warning lamp → P.4-18
- 10- High coolant temperature warning lamp (red) → P.5-15
- 11- Low coolant temperature indicator lamp (green) → P.5-12
- 12- Check engine warning lamp → P. 5-14
- 13- Oil pressure warning lamp → P. 5-15
- 14- Charge warning lamp → P. 5-14
- 15- Brake warning lamp → P.5-13

- 16- Anti-lock brake system (ABS) warning lamp → P.6-34
- 17- Multi-information display → P.5-2
- 18- For details, refer to “Warning activator” on page 3-11. (if so equipped)
- 19- Seat belt warning lamp → P.4-7
- 20- Forward Collision Mitigation System (Low speed range) (FCM-LS) and Radar sensing misacceleration Mitigation System (RMS) (Forward) OFF indicator lamp* → P. 6-48, 6-49
- 21- Cruise control indicator lamp* → P.6-39

- 22- Active Stability Control (ASC) indicator lamp → P.6-37
- 23- Active Stability Control (ASC) OFF indicator lamp → P.6-37
- 24- Position lamp indicator lamp → P. 5-12
- 25- Auto Stop & Go (AS&G) indicator → P.6-20
- 26- ECO indicator lamp → P.5-13



General information

Fuel selection	2-2
Filling the fuel tank	2-2
Installation of accessories	2-3
Modification/alterations to the electrical or fuel systems	2-4
Genuine parts	2-5
Used engine oils safety instructions	2-5
Event Data Recording	2-5

Fuel selection

2

Fuel selection

E00200105780

Recommended fuel	Unleaded petrol octane number 90 RON or higher
------------------	---

CAUTION

- The use of leaded fuel can result in serious damage to the engine and catalytic converter. Do not use the leaded fuel.

NOTE

- Repeatedly driving short distance at low speeds can cause deposits to form in the fuel system and engine, resulting in poor starting and poor acceleration. If these problems occur, you are advised to add a detergent additive to the gasoline when you refuel the vehicle. The additive will remove the deposits, thereby returning the engine to a normal condition. Be sure to use a MITSUBISHI MOTORS GENUINE FUEL SYSTEM CLEANER. Using an unsuitable additive could make the engine malfunction. For details, please contact the nearest authorised MITSUBISHI MOTORS dealer.

NOTE

- Poor quality petrol can cause problems such as hard starting, stalling, engine noise and hesitation. If you experience these problems, try another brand and/or grade of petrol. If the check engine warning lamp flashes, have the system checked as soon as possible at an authorised MITSUBISHI MOTORS dealer.

Ethanol/Gasohol

A mixture of up to 20 % ethanol (grain alcohol) and 80 % unleaded petrol may be used in your vehicle, provided the octane number is at least as high as that recommended for unleaded petrol.

CAUTION

- Do not use more than 20 % concentration of ethanol (grain alcohol) by volume. Use of more than 20 % concentration may lead to damage to your vehicle fuel system, engine, engine sensors and exhaust system.
- Do not operate your vehicle on petrol containing methanol. Using this type of alcohol could adversely affect the vehicle's performance and damage critical parts of the vehicle's fuel system.

Filling the fuel tank

E00200203846

WARNING

- When handling fuel, comply with the safety regulations displayed by garages and filling stations.
- Gasoline is highly flammable and explosive. You could be burned or seriously injured when handling it. When refueling your vehicle, always turn the engine off and keep away from flames, sparks, and smoking materials. Always handle fuel in well-ventilated outdoor areas.
- Before removing the fuel tank filler cap, be sure to get rid of your body's static electricity by touching a metal part of the car or fuel pump. Any static electricity on your body could create a spark that ignites fuel vapor.
- Perform the whole refueling process (opening the fuel tank filler door, removing the fuel tank filler cap, etc.) by yourself. Do not let any other person come near the fuel tank filler. If you allowed a person to help you and that person was carrying static electricity, fuel vapor could be ignited.
- Do not move away from the fuel tank filler until refueling is finished. If you moved away and did something else (for example, sitting on a seat) part-way through the refueling process, you could pick up a fresh charge of static electricity.

⚠ WARNING
 ● If the fuel tank filler cap must be replaced, use only a MITSUBISHI MOTORS genuine part.

Fuel tank capacity

35 litres

Refueling

1. Before filling with fuel, stop the engine.
2. The fuel tank filler is located on the rear left side of your vehicle.
 Open the fuel tank filler door with the release lever located on the side of the driver's seat.

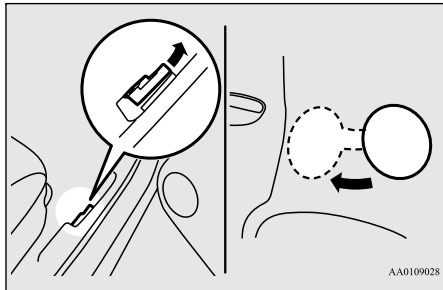

3. Open the fuel tank filler tube by slowly turning the cap anticlockwise.

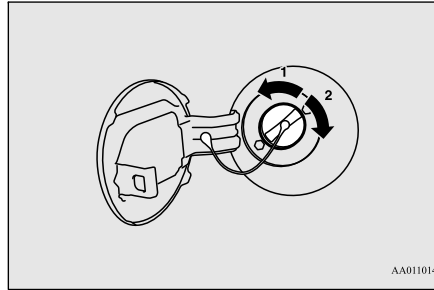

- 1- Remove
- 2- Close

⚠ CAUTION
 ● Since the fuel system may be under pressure, remove the fuel tank filler cap slowly. This relieves any pressure or vacuum that might have built up in the fuel tank. If you hear a hissing sound, wait until it stops before removing the cap. Otherwise, fuel may spray out, injuring you or others.

4. While filling with fuel, hang the fuel tank filler cap cord on the hook located on the inside of the fuel tank filler door.

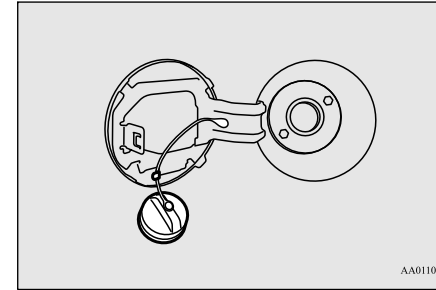

5. Insert the gun in the tank port as far as it goes.

⚠ CAUTION
 ● Do not tilt the gun.

6. When the gun stops automatically, do not fill with fuel any more.
7. To close, turn the fuel tank filler cap slowly clockwise until you hear clicking sounds, then gently push the fuel tank filler door closed.

Installation of accessories

E00200302811

Before fitting any accessories, please consult your authorised MITSUBISHI MOTORS dealer.

Modification/alterations to the electrical or fuel systems

2

CAUTION

- Your vehicle is equipped with a diagnosis connector for checking and servicing the electronic control system.

Do not connect a device other than a diagnosis tool for inspections and service to this connector. Otherwise, the battery could be discharged, the electronic devices of the vehicle could malfunction, or other unexpected problems could result.

In addition, malfunctions caused by connecting a device other than a diagnosis tool may not be covered under warranty.

- The installation of accessories, optional parts, etc., should only be carried out within the limits prescribed by law in your country, and in accordance with the guidelines and warnings contained within the documents accompanying this vehicle. Only MITSUBISHI MOTORS approved accessories should be fitted to your vehicle.
- Improper installation of electrical parts could cause fire, please refer to the Modification/alteration to the electrical or fuel systems section within this owner's manual.
- Using a cellular phone or radio set inside the vehicle without an external antenna may cause electrical system interference, which could lead to unsafe vehicle operation.

2-4 General information

- Tyres and wheels which do not meet specifications must not be used. Refer to the "Specifications" section for information regarding wheel and tyre sizes.
- Do not fail to read the accessories manuals prior to the installation of accessories, parts or other modifications to the vehicle!

Important points!

Due to the large number of accessory and replacement parts of different manufactures in the market, it is not possible, not only for MITSUBISHI MOTORS CORPORATION, but also an authorised MITSUBISHI MOTORS dealer, to check whether the attachment or installation of such parts affects the driving safety of your vehicle.

Even when such parts are officially authorised, for example by a "general operators permit" (an appraisal for the part) or through the execution of the part in an officially approved manner of construction, or when a single operation permit following the attachment or installation of such parts, it cannot be deduced from that alone, that the driving safety of your vehicles has not been affected.

Consider also that there basically exists no liability on the part of the appraiser or the official. Only in the case of parts (MITSUBISHI MOTORS original replacement or exchange parts as well as MITSUBISHI MOTORS accessories) that are recommended and released by an authorised MITSUBISHI MOTORS dealer and that are attached or installed by an authorised MITSUBISHI MOTORS dealer can you assume, that optimal safety has been provided. The same also pertains to modifications of vehicles with respect to the production specifications. For your own safety, in such cases as well, you should only undertake modifications according to the recommendations of an authorised MITSUBISHI MOTORS dealer.

Modification/alterations to the electrical or fuel systems

E00200400430

MITSUBISHI MOTORS has always manufactured safe, high quality vehicles. In order to maintain this safety and quality, it is important that any accessory that is to be fitted, or any modifications carried out which involve the electrical or fuel systems, should be carried out in accordance with MITSUBISHI MOTORS guidelines.

⚠ CAUTION

- Please consult an authorised MITSUBISHI MOTORS dealer concerning any such fitment or modification.

If the wires interfere with the vehicle body or improper installation methods are used (protective fuses not included, etc.), electronic devices may be adversely affected, resulting in a fire or other accident.

Genuine parts
E00200502044

Don't play around with substitutes. MITSUBISHI MOTORS has gone to great lengths to bring you a superbly crafted vehicle offering the highest quality and dependability. Don't reduce that quality and dependability by using substitute parts. Always use MITSUBISHI MOTORS Genuine Parts designed and manufactured to maintain your vehicle at top performance. The operation of vehicle components can be less efficient in case of using Non-Genuine Parts. Failure to use Genuine Parts may invalidate any future warranty claim. MITSUBISHI MOTORS will not be liable for any malfunction of your vehicle that may have been caused by the use of substitute parts in place of MITSUBISHI MOTORS Genuine Parts. At the MITSUBISHI MOTORS dealer you can also get appropriate advice and the

assembling of Genuine Parts will be handled professionally. MITSUBISHI MOTORS Genuine Parts are indicated as GENUINE PARTS, and are available at all authorised MITSUBISHI MOTORS dealers.

Used engine oils safety instructions
E00200600171

⚠ WARNING

- **Prolonged and repeated contact may cause serious skin disorders, including dermatitis and cancer.**
- **Avoid contact with the skin as far as possible and wash thoroughly after any contact.**
- **Keep out of reach of children.**

Event Data Recording
E00205900094

This vehicle is equipped with an event data recorder (EDR). The main purpose of an EDR is to record, in certain crash or near crash-like situations, such as an airbag deployment or hitting a road obstacle, data that will assist in understanding how a vehicle's systems performed.

The EDR is designed to record data related to vehicle dynamics and safety systems for a short period of time, typically 30 seconds or less.

The EDR in this vehicle is designed to record such data as:

- How various systems in your vehicle were operating;
- How far (if at all) the driver was depressing the accelerator and/or brake pedal; and,
- How fast the vehicle was traveling.

These data can help provide a better understanding of the circumstances in which crashes and injuries occur.

📖 NOTE

- EDR data are recorded by your vehicle only if a non-trivial crash situation occurs; no data are recorded by the EDR under normal driving conditions and no personal data (e.g., name, gender, age, and crash location) are recorded. However, other parties, such as law enforcement, could combine the EDR data with the type of personally identifying data routinely acquired during a crash investigation.

To read data recorded by an EDR, special equipment is required, and access to the vehi-

Event Data Recording

2

cle or the EDR is needed. In addition to the vehicle manufacturer, other parties, such as law enforcement, that have the special equipment, can read the information if they have access to the vehicle or the EDR.

Locking and unlocking

Keys	3-2
Electronic immobilizer (Anti-theft starting system)*	3-3
Keyless entry system	3-4
Keyless operation system*	3-7
Doors	3-15
Central door locks	3-16
“Child-protection” rear doors	3-17
Tailgate	3-17
Electric window control	3-18

Keys

Keys

E0030010423

3

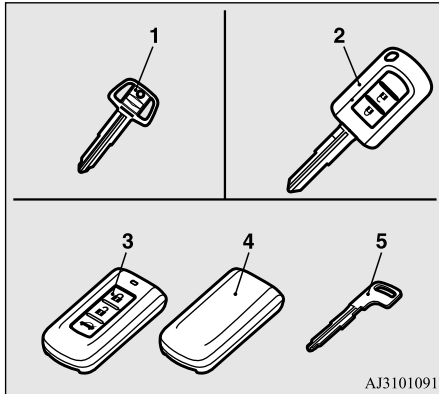

AJ3101091

- 1- Master key (Plate)
- 2- Keyless entry key
- 3- Keyless operation key
- 4- Spare key
- 5- Emergency key

WARNING

- When carrying a remote control key on flights, do not press any switches on the key while on the plane. If a switch is pressed on the plane, the key emits electromagnetic waves, which could adversely affect the plane's flight operation. When carrying a remote control key in a bag, be careful that no switches on the key can be easily pressed by mistake.

NOTE

- On vehicles with electric immobilizer, the key (except for the emergency key) is a precision electronic part with a built-in signal transmitter. Please observe the following in order to prevent a malfunction.
 - Do not leave anywhere that is exposed to direct sunlight, for example on the dashboard.
 - Do not disassemble or modify.
 - Do not excessively bend the key or subject it to a strong impact.
 - Do not expose to water.
 - Keep away from magnetic key rings.
 - Keep away from audio systems, personal computers, TVs, and any other equipment that generates a magnetic field.

NOTE

- Keep away from devices that emit strong electromagnetic waves, such as cellular phones, wireless devices and high frequency equipment (including medical devices).
- Do not wash with ultrasonic cleaners or similar equipment.
- Do not leave the key where it may be exposed to high temperature or high humidity.
- On vehicles with electric immobilizer, the engine is designed so that it will not start if the ID code registered in the immobilizer computer and the key's ID code do not match. Refer to the section entitled "Electronic immobilizer" for details and key usage.

Key number tag

The key number is stamped on the tag as indicated in the illustration.

Make a record of the key number and store the key and key number tag in separate places, so that you can order a key from your authorised MITSUBISHI MOTORS dealer in the event the original keys are lost.

[Except for vehicles equipped with the keyless operation system]

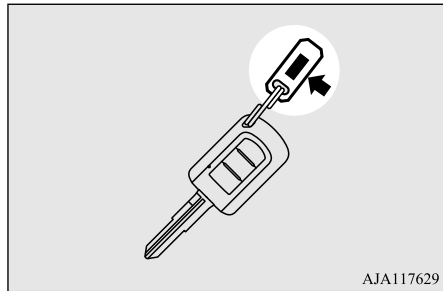

[Vehicles equipped with the keyless operation system]

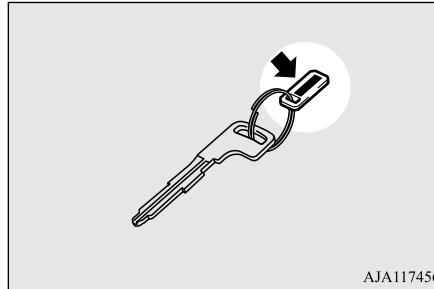

Electronic immobilizer (Anti-theft starting system)*

E00300204147

The electronic immobilizer is designed to reduce significantly the possibility of vehicle theft. The purpose of the system is to immobilize the vehicle if an invalid start is attempted. A valid start attempt can only be achieved, using a key “registered” to the immobilizer system.

CAUTION

- Don't make any alterations or additions to the immobilizer system; alterations or additions could cause failure of the immobilizer.

NOTE

- In the following cases, the vehicle may not be able to receive the registered ID code from the registered key and the engine may not start. (vehicles with keyless entry key)
- When the key contacts a key ring or other metallic or magnetic object

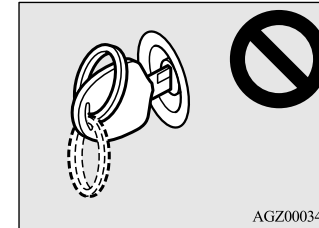

- When the key grip contacts metal of another key

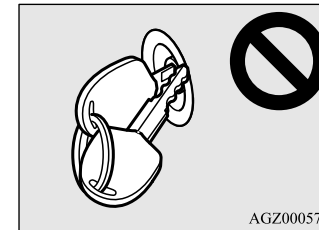

3

Keyless entry system

3

NOTE

- When the key contacts or is close to other immobilizing keys (including keys of other vehicles)



In cases like these, remove the object or additional key from the vehicle key. Then try again to start the engine. If the engine does not start, contact an authorised MITSUBISHI MOTORS dealer.

- If you lose one of the keyless operation keys, contact an authorised MITSUBISHI MOTORS dealer as soon as possible. Refer to “Keys” on page 3-2.

To obtain a key, take your vehicle and all remaining keys to an authorised MITSUBISHI MOTORS dealer.

If you need an extra spare key, take your vehicle and all the keys to an authorised MITSUBISHI MOTORS dealer. All the keys have to be re-registered in the immobilizer computer unit.

For further information, please contact an authorised MITSUBISHI MOTORS dealer.

Keyless entry system

E00300304526

Press the remote control switch, and all doors and the tailgate will be locked or unlocked as desired.

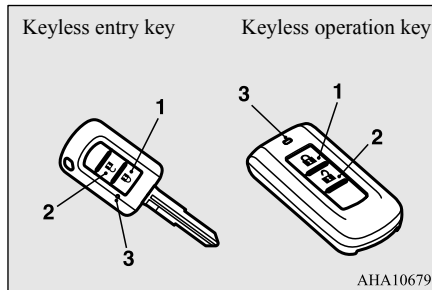

- 1- LOCK switch
- 2- UNLOCK switch
- 3- Indicator lamp

To lock

Press the LOCK switch (1). All the doors and the tailgate will be locked. The turn-signal lamps will blink once. When they are locked with the room lamp switch in the middle (●) position, the room lamp also blink once.

To unlock

Press the UNLOCK switch (2). All the doors and the tailgate will be unlocked. If the room lamp switch is in the middle (●) position at this time, the room lamp will come on for approximately 15 seconds and the turn-signal lamps will blink twice.

NOTE

- For vehicles equipped with the mirror retractor switch, the outside rear-view mirrors automatically retract or extend when all the doors and the tailgate are locked or unlocked using the remote control switches of the keyless entry system. Refer to “Starting and driving: Outside rear-view mirrors” on page 6-8.
- If the UNLOCK switch (2) is pressed and no door or tailgate is opened within approximately 30 seconds, relocking will automatically occur.
- It is possible to modify functions as follows: For further information, please contact your authorised MITSUBISHI MOTORS dealer.
 - The time from pressing of the UNLOCK switch (2) to the moment of automatic locking can be changed.
 - Activating the operation confirmation function (blinking of the turn-signal lamps) only during locking, or only during unlocking.

 **NOTE**

- The confirmation function (this indicates locking or unlocking of the doors and tailgate with the blink of the turn-signal lamps) can be deactivated.
- The number of times the turn-signal lamps are blinked by the confirmation function can be changed.
- On vehicles with keyless operation system, the buzzer sound can be activated when a keyless operation is done.
- The keyless entry system does not operate in the following conditions:
 - The key is left in the ignition switch. (except for vehicles with keyless operation system)
 - The operation mode is not in OFF. (vehicles with keyless operation system)
 - The door or tailgate is open.
- The remote control switch will operate within approximately 4 m from the vehicle. However, the operating range of the remote control switch may change if the vehicle is located near a TV transmitting tower, power station, or radio broadcasting station.
- If either of the following problems occurs, the battery may be exhausted.
 - The remote control switch is operated at the correct distance from the vehicle, but the doors and tailgate are not locked/unlocked in response.

 **NOTE**

- The indicator lamp (3) is dim or does not come on.
- For further information, please consult your authorised MITSUBISHI MOTORS dealer. If you replace the battery yourself, refer to “Procedure for replacing the remote control switch battery” on page 3-5.
- If your remote control switch is lost or damaged, please contact an authorised MITSUBISHI MOTORS dealer for a replacement remote control switch.
 - If you wish to add remote control switch, please contact an authorised MITSUBISHI MOTORS dealer.

The following numbers of the remote control switches are available.

 - Keyless entry key: up to 4 keys
 - Keyless operation key: up to 4 keys

Procedure for replacing the remote control switch battery

E00309502367

 **WARNING**

- Do not swallow a coin type battery.

 **WARNING**

- **This product contains coin type battery. If a coin type battery is swallowed, it can cause severe internal burns and can lead to death.**

There have been cases where a swallowed battery has caused severe internal burns in just 2 hours.
- **Keep new and used batteries away from children.**
- **If the remote control switch case does not close securely, stop using the product and keep it away from children.**
- **If you think batteries might have been swallowed or placed inside any part of a person’s body, seek immediate medical attention.**
- **To prevent an explosion or leakage of flammable liquid or gas:**
 - **Do not replace the battery with an incorrect type. Replace only with the same or equivalent type.**
 - **Do not dispose of a battery into a fire or incinerator, or by mechanically crushing or cutting the battery.**
 - **Do not use, store, or take a battery any place where it may be exposed to extremely high temperature or extremely low air pressure.**

3

Keyless entry system

3

CAUTION

- When the remote control switch case is opened, be careful to keep water, dust, etc. out. Also, do not touch the internal components.
- Dispose of used battery according to regulations for the disposal of battery.

NOTE

- You may purchase a replacement battery at an electric appliance store.
- An authorised MITSUBISHI MOTORS dealer can replace the battery for you if you prefer.

Keyless entry key

1. Before replacing the battery, remove static electricity from your body by touching a metal grounded object.

2. Remove the screw (A) from the remote control switch.

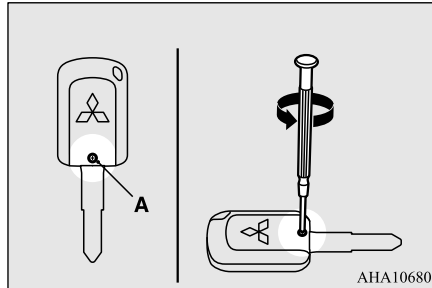

3. With the MITSUBISHI mark facing you, insert the cloth-covered tip of a straight blade (or minus) screwdriver into the notch in the remote control switch case and use it to open the case.

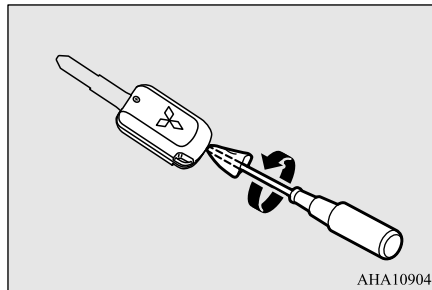

NOTE

- Be sure to perform the procedure with the MITSUBISHI mark facing you. If the MITSUBISHI mark is not facing you when you open the remote control switch case, the switches may come out.

4. Remove the used battery.
5. Install a new battery with the + side up.

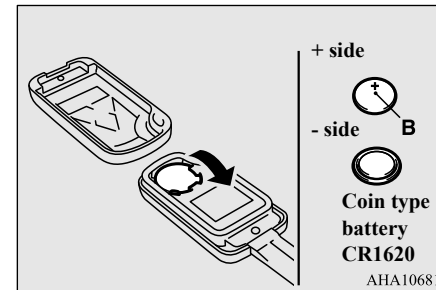

6. Close the remote control transmitter firmly.
7. Attach the screw (A) removed in step 2.
8. Check the keyless entry system to see that it works.

Keyless operation key

1. Before replacing the battery, remove static electricity from your body by touching a metal grounded object.

Keyless operation system*

2. Remove the emergency key from the key. Refer to “Emergency key” on page 3-11.
3. With the MITSUBISHI mark facing you, insert the cloth-covered tip of a straight blade (or minus) screwdriver into the notch in the remote control switch case and use it to open the case.

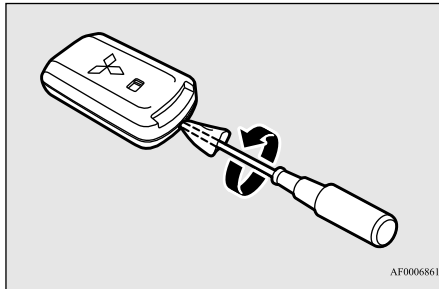

NOTE

- Be sure to perform the procedure with the MITSUBISHI mark facing you. If the MITSUBISHI mark is not facing you when you open the remote control switch case, the transmitter may come out.

4. Remove the used battery.

5. Install a new battery with the + side (A) up.

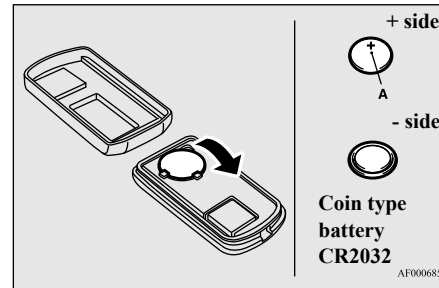

6. Close the case firmly.
7. Install the emergency key removed in step 2.
8. Check the keyless operation function to see that it works.

Keyless operation system*

E00305602748

The keyless operation system allows you to lock and unlock the doors and tailgate, start the engine and change the operation mode simply by carrying the keyless operation key with you.

The keyless operation key can also be used as the keyless entry system remote control switch.

Refer to “Starting” on page 6-16.

Refer to “Keyless entry system” on page 3-4.

The driver should always carry the keyless operation key. This key is necessary for locking and unlocking the doors and tailgate, starting the engine and otherwise operating the vehicle, so before locking and leaving the vehicle, be sure to check that you have the keyless operation key.

3

NOTE

- The spare key of keyless operation keys does not have keyless operation functions equivalent to keyless operation key.
- Use the spare key when starting the engine in case of an emergency. Refer to “Engine switch” on page 6-12.
- Use the emergency key when opening the door in case of an emergency. Refer to “Keys” on page 3-2.

WARNING

- People with implantable cardiac pacemakers or implantable cardiovascular-defibrillators should not go near the exterior transmitters (A) or the interior transmitters (B). The radio waves used by the keyless operation system could adversely affect implantable cardiac pacemakers or implantable cardiovascular-defibrillators.

Keyless operation system*

3

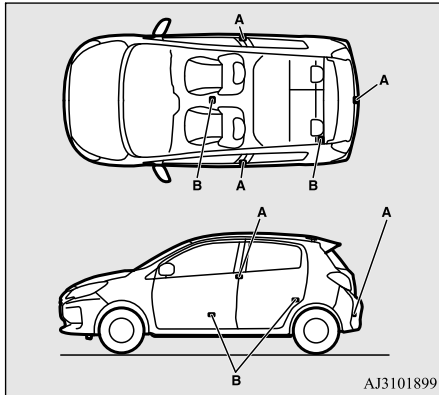

⚠ WARNING

- When using electro-medical devices other than implantable cardiac pacemakers or implantable cardiovascular-defibrillators, contact the electro-medical device manufacturer ahead of time to determine the affects of radio waves on the devices. Electromedical device operations could be affected by radio waves.

You can limit the possible operations of the keyless operation system. in the following ways. (The keyless operation system can be used as a keyless entry system.) Please consult an authorised MITSUBISHI MOTORS dealer for details.

- You can limit operations to locking and unlocking the doors and tailgate.
- You can limit operations to starting the engine.
- The keyless operation system can be disabled.

📖 NOTE

- The keyless operation key uses an ultra-weak electromagnetic wave. In the following cases, the keyless operation system may not operate properly or may be unstable.
- When there is equipment nearby that emits strong radio waves, such as: a power station, a radio/TV broadcasting station or an airport.
- The keyless operation system is carried together with a communications device such as a cellular phone or radio set, or with an electronic device such as a personal computer.
- The keyless operation key is touching or covered by a metal object.
- A keyless entry system is being used nearby.
- When the keyless operation key battery is worn out.
- When the keyless operation key is set down in an area with strong radio waves or noise. In such cases, use the emergency key. Refer to “To lock/unlock without using the keyless operation function” on page 3-11.

📖 NOTE

- Because the keyless operation key receives signals in order to communicate with the transmitters in the vehicle, the battery continually wears down regardless of keyless operation key use. The battery life is 1 to 2 years, depending on usage conditions. When the battery wears out, replace the battery according to the description in this manual or have it replaced at your authorised MITSUBISHI MOTORS dealer. Refer to “Procedure for replacing the remote control switch battery” on page 3-5.
- Because the keyless operation key continually receives signals, strong radio wave reception could affect battery wear. Do not leave the key near a TV, personal computer, or other electronic device.

Operating range of the keyless operation system

E00305701957

If you are carrying the keyless operation key, enter the operating range of the keyless operation system, and press the driver's door lock/unlock switch, or the tailgate lock/unlock switch, the ID code for your key is verified.

You can only lock and unlock the doors and tailgate, start the engine and change the operation mode if the ID codes of your keyless operation key and the vehicle match.

NOTE

- If the keyless operation key battery is wearing out or there are strong electromagnetic waves or noise present, the operating range may become smaller and operation may become unstable.

Operating range for locking and unlocking the doors and tailgate

E00306201829

The operating range is approximately 70 cm from the driver's door lock/unlock switch and the tailgate lock/unlock switch.

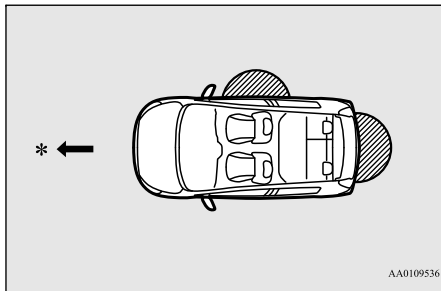

*: Forward direction
 [Hatched Box]: Operating range

NOTE

- Locking and unlocking are only possible when the door or tailgate is operated while the keyless operation key is being detected.
- Operation may not be possible if you are too close to the front door, door window, or tailgate.
- Even if the keyless operation key is within 70 cm of the driver's door lock/unlock switch or the tailgate lock/unlock switch, if the key is near to the ground or high up, the system may not operate.
- If the keyless operation key is within the operating range, even someone not carrying the key can lock and unlock the doors and tailgate by pressing the driver's door lock/unlock switch or the tailgate lock/unlock switch.

Operating range for starting the engine and changing the operation mode

E00306301602

3

The operating range is the interior of the vehicle.

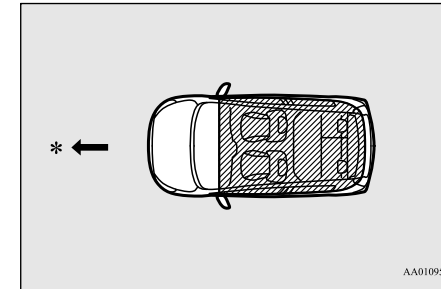

*: Forward direction
 [Hatched Box]: Operating range

NOTE

- Even if it is within the operating range, if the keyless operation key is in a small item holder such as the glove box, on top of the instrument panel, door pocket or in the luggage compartment, it may be impossible to start the engine and change the operation mode.

Keyless operation system*

3

NOTE

- If a keyless operation key is too close to the door or door window, it may be possible to start the engine or change the operation mode even when the key is outside the vehicle.

To operate using the keyless operation function

E00305803271

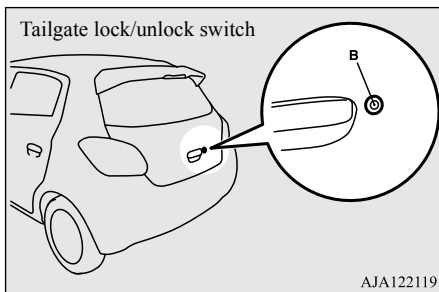
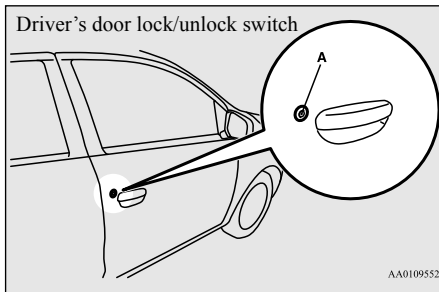

Locking the doors and tailgate

When you are carrying the keyless operation key, if you press the driver's door lock/unlock switch (A), or the tailgate lock/unlock switch (B) within the operating range, the doors and the tailgate are locked.

The turn-signal lamps will blink once and the outer buzzer will sound once.

Also refer to "Locking and unlocking: Doors, Central door locks, tailgate" on pages 3-15, 3-16 and 3-17.

Unlocking the doors and tailgate

When you are carrying the keyless operation key, if you press the driver's door lock/unlock switch (A), or the tailgate lock/unlock switch (B) within the operating range, all the doors and tailgate are unlocked.

If the room lamp switch is in the middle (●) position at this time, the room lamp will turn on for 15 seconds. The turn-signal lamps will blink twice and the outer buzzer will sound twice.

If the driver's door lock/unlock switch is pressed and any of the doors or tailgate is not opened within approximately 30 seconds, relocking will automatically occur.

Refer to "Locking and unlocking: Doors, Central door locks, tailgate" on pages 3-15,

3-16 and 3-17.

NOTE

- For vehicles equipped with the mirror retractor switch, the outside rear-view mirrors automatically retract/extend when all the doors and the tailgate are locked/unlocked using the keyless operation function. Refer to "Starting and driving: Outside rear-view mirrors" on page 6-8.
- The keyless operation function does not operate under the following conditions:
 - The keyless operation key is inside the vehicle.
 - A door or the tailgate is open or ajar.
 - The operation mode is not in OFF.
- The time between unlocking and automatic locking can be adjusted. Please consult an authorised MITSUBISHI MOTORS dealer.

Operation confirmation when locking and unlocking

Operation can be confirmed as shown below. However, the room lamp will illuminate only if the room lamp switch is in the middle (●) position.

When locking: The turn-signal lamps blink once and the outer buzzer sounds once.

When The room lamp illuminates for unlocking: approximately 15 seconds, the turn-signal lamps blink twice, and the outer buzzer sounds twice.

NOTE

- Functions can be modified as stated below. For further information, please contact your authorised MITSUBISHI MOTORS dealer.
- Activating the operation confirmation function (blinking of the turn-signal lamps) only during locking, or only during unlocking.
- Disabling the operation confirmation function (blinking of the turn-signal lamps) and outer buzzer.
- Changing the number of blinks for the operation confirmation function (blinking of the turn-signal lamps).

To lock/unlock without using the keyless operation function

E00306000165

Emergency key

E00307200438

The emergency key (A) can only be used to lock and unlock the front passenger's door.

Warning activator

E00305902422

In order to prevent vehicle theft or the accidental operation of the keyless operation system, the lamp and buzzer are used to alert the driver.

To use the emergency key, unlock the lock knob (B) and remove it from the keyless operation key (C).

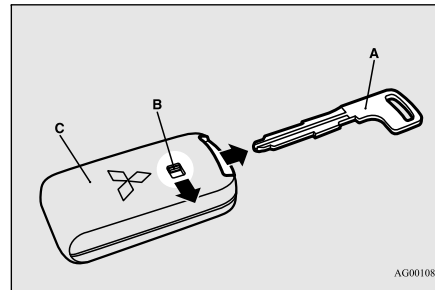

NOTE

- Only use the emergency key for emergencies. If the keyless operation key battery wears out, replace it as quickly as possible so that you can use the keyless operation key.
- The emergency key is built in the keyless operation key and spare key.
- After using the emergency key, always return it into the original position.

Locking and unlocking the front passenger's door

Turning the emergency key in the forward direction locks the door, and turning it in the rear direction unlocks the door. Also refer to "Locking and unlocking: Doors" on page 3-15.

3

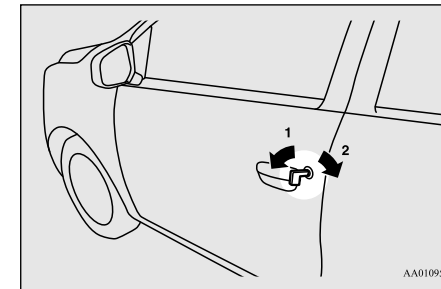

- 1- Lock
- 2- Unlock

Keyless operation system*

3

Lamp 	Buzzer	Item	Cause	Note (Solution)
Blinks	Outer buzzer sounds 4 times. Inner buzzer sounds.	Keyless operation key take-out monitoring system	When the vehicle is parked with the operation mode in any mode other than OFF, if you close the door after opening any of the doors and taking the keyless operation key out of the vehicle. Outer buzzer sounds 4 times at this time. And when a vehicle starts, inner buzzer sounds once.	<ul style="list-style-type: none"> ● If you take the keyless operation key out of the vehicle through a window without opening a door, this system does not operate. ● It is possible to change the setting to make the system operate if you take the keyless operation key out from the vehicle through a window without opening a door. For further information, please contact an authorised MITSUBISHI MOTORS dealer. ● Even if you have the keyless operation key within the engine start operating range, if the key and vehicle ID codes cannot be matched, for example due to the ambient environment or electromagnetic conditions, the warning may be activated.
Blinks	Outer buzzer sounds approximately 3 seconds	Key lock-in prevention system	When the operation mode is in OFF, if you close all the doors and the tailgate with the keyless operation key left in the vehicle and you try to lock the doors and tailgate by pressing the driver's door lock/unlock switch, or the tailgate lock/unlock switch.	Make sure you have the keyless operation key with you before locking the doors. Even if you leave the keyless operation key inside the vehicle, it is possible that the doors will lock depending on the surrounding environment and wireless signal conditions.

Keyless operation system*

Lamp 	Buzzer	Item	Cause	Note (Solution)
Blinks	Outer buzzer sounds approximately 3 seconds	Door ajar prevention system	When the operation mode is in OFF, if you try to lock the doors and tailgate by pressing the driver's door lock/unlock switch, or the tailgate lock/unlock switch with one of the doors or the tailgate not completely closed.	—
Blinks	No sounds	Keyless operation system	The battery of the keyless operation key has worn out.	Replace the battery as soon as possible at an authorised MITSUBISHI MOTORS dealer. If you replace the battery yourself, refer to "Procedure for replacing the remote control switch battery" on page 3-5.
Illuminates			There is a fault in the keyless operation system.	If the warning lamp illuminates, please contact an authorised MITSUBISHI MOTORS dealer.
	Inner buzzer sounds (intermittent sounds)		There is a fault in the electrical system.	
	Inner buzzer sounds (continuous sounds)			Immediately stop the vehicle in a safe place and contact an authorised MITSUBISHI MOTORS dealer.
Blinks	Outer buzzer sounds approximately 3 seconds. Inner buzzer sounds approximately 1 minute.	Keyless operation key reminder	When the operation mode is in OFF with the keyless operation key left in the key slot, if you try to open the driver's door.	Remove the keyless operation key from the key slot. Refer to "Starting" on page 6-16.

3

Keyless operation system*

3

Lamp 	Buzzer	Item	Cause	Note (Solution)
Illuminates	Inner buzzer sounds	Steering wheel lock	There is a fault in the steering wheel lock system.	Refer to “Steering wheel lock” on page 6-14.
Blinks	Outer buzzer sounds approximately 3 seconds	Operation mode OFF reminder system	When the operation mode is in any mode other than OFF with all the doors and the tailgate are closed, if you try to lock by using the driver’s door lock/unlock switch or the tailgate lock/unlock switch.	Refer to “Operation mode OFF reminder system” on page 6-14.

Lamp 	Buzzer	Item	Cause	Note (Solution)
Illuminates	No sounds	Immobilizer system	There is a fault in the electronic immobilizer (Anti-theft starting system).	Put the operation mode in OFF and then start the engine again. If the warning is not cancelled, contact an authorised MITSUBISHI MOTORS dealer.
Blinks	Inner buzzer sounds	Steering wheel lock	Steering wheel does not unlock.	Unlock the steering wheel lock following the procedure of reference page. Refer to “Steering wheel lock” on page 6-14.
Illuminates	No sounds		Steering wheel lock is abnormal.	Refer to “Steering wheel lock” on page 6-14.

Doors

E00300402262

⚠ CAUTION

- Make sure the doors are closed: driving with doors not completely closed is dangerous.
- Never leave children in the vehicle unattended.
- Be careful not to lock the doors while the key is inside the vehicle.

To lock or unlock with the key

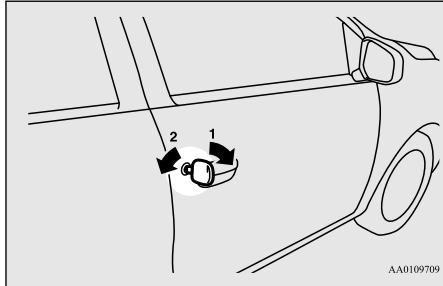

- 1- Lock
- 2- Unlock

To lock or unlock from inside the vehicle

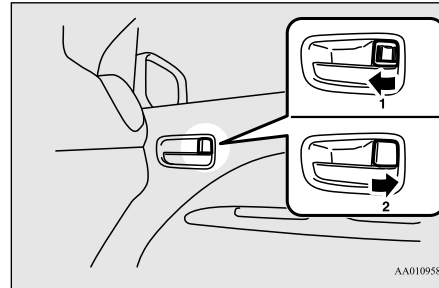

- 1- Lock
- 2- Unlock

📖 NOTE

- The driver's door can be opened without using the lock knob by pulling on the inside door handle.

To lock without using the key

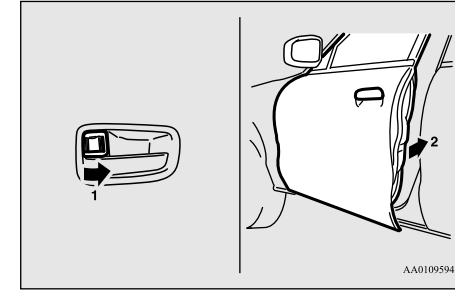

3

Set the inside lock knob (1) to the locked position, and close the door (2).

“Forgotten-key-prevention” mechanism*

E00300600329

If the key is in the ignition switch or the operation mode is other than OFF, when you push the lock knob forward with the driver's door open, the lock knob will automatically return to the unlocked position.

Central door locks

Central door locks

E00300803582

3

NOTE

- When locking or unlocking with the key on the driver's door, only the driver's door will lock or unlock.
- Repeated continuous operation between lock and unlock could activate the central door locking systems built-in protection circuit, and prevent the system from operating. If this occurs, wait approximately 1 minute before operating the central door lock switch.

To lock and unlock the doors and tailgate

E00312001079

Using the central door lock switch

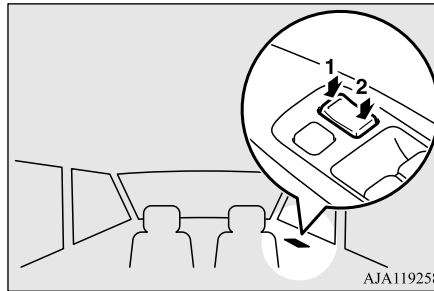

AJA119258

- 1- Lock
- 2- Unlock

All of the doors and the tailgate can be locked or unlocked by pressing the central door lock switch on the driver's door.

To unlock the doors and tailgate

E00311801429

You can select the functions to unlock the doors and tailgate either using the ignition switch or the engine switch, or using the selector lever position (CVT).

These functions are not activated when the vehicle is shipped from the factory. To activate or deactivate these functions, please contact an authorised MITSUBISHI MOTORS dealer.

Using the selector lever position (CVT)

All doors and the tailgate will unlock when the selector lever is moved to the "P" (PARK) position with the ignition switch or the operation mode in ON.



AA0109666

“Child-protection” rear doors

E00300901039

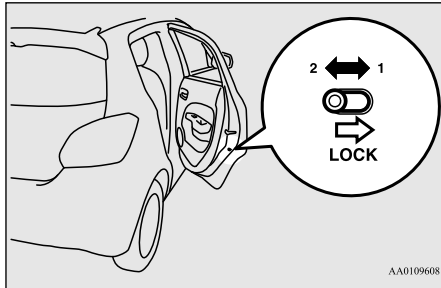

AA0109608

- 1- Lock
- 2- Unlock

Child protection helps prevent doors from being opened accidentally, especially when small children are in the rear seat.

A lever is provided on each rear door.

If the lever is set to the locked position, the rear door cannot be opened using the inside handle.

To open the rear door while the child protection is in use, pull the outside door handle.

If the lever is set to the “Unlock” position, the child protection mechanism does not function.

⚠ CAUTION

- When driving with a child in the rear seat, please use the child protection to prevent accidental door opening which may cause an accident.

Tailgate

E00301403006

⚠ WARNING

- Luggage compartment is not designed to ride for people. Do not let people ride or children play there. This could result in a serious accident.
- It is dangerous to drive with the tailgate open, since carbon monoxide (CO) gas can enter the cabin. You cannot see or smell CO. It can cause unconsciousness and even death. And also, if opening the tailgate while driving, luggage may fall from the tailgate. This could result in a serious accident.
- When opening and closing the tailgate, make sure of the surrounding safety and keep enough space for back and upper of the vehicle and be careful not to hit your head or pinch your hands, neck, etc.

⚠ WARNING

- When there is a build up of snow or ice, it should be removed before opening the tailgate. If you open the tailgate without removing it, there is a possibility that the tailgate may close suddenly due to the weight of that snow or ice.
- When you open the tailgate make sure that the tailgate is opened fully and remains fully open. If you only open the tailgate halfway there is a risk that the tailgate may drop and slam shut. If you open the tailgate whilst your vehicle is parked on an incline it is more difficult to do so than on the flat and also it may drop and slam shut.

3

⚠ CAUTION

- Do not stand behind the exhaust pipe when loading and unloading luggage. Heat from the exhaust could lead to burns.
- To avoid damage to the tailgate, make sure the area above and behind the tailgate is clear before opening it.

📖 NOTE

- Locking/unlocking with the inside lock knob of the driver’s door, the keyless entry system or the keyless operation function also locks/unlocks the tailgate.

Electric window control

To open

3

[Except for vehicles equipped with the keyless operation system]

After unlocking the tailgate, pull the tailgate handle upward to open.

[Vehicles equipped with the keyless operation system]

After pressing the tailgate lock/unlock switch (A), pull the tailgate handle upward to open.

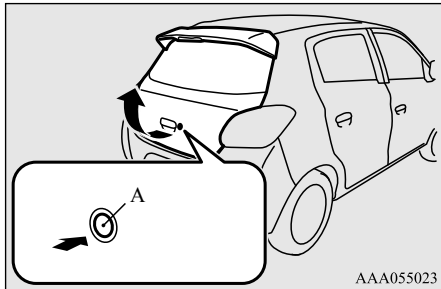

To close

To close the tailgate, pull the tailgate grip (A) downward and release it before the tailgate is completely closed, then gently push shut the tailgate from the outside.

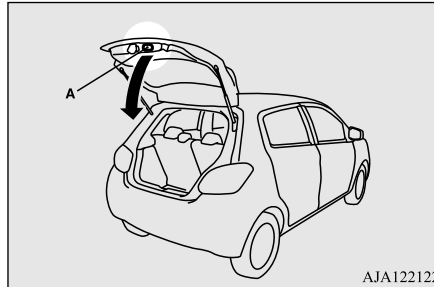

CAUTION

- When closing the tailgate, do not close it directly putting the hands on the tailgate grip. If the hands or arms got caught, a serious injury could result.
- Before driving, make sure that the tailgate is securely closed.

If the tailgate opens while driving the vehicle, objects stored in the luggage compartment could fall out onto the road.

NOTE

- Gas struts (B) are installed to support the tailgate.

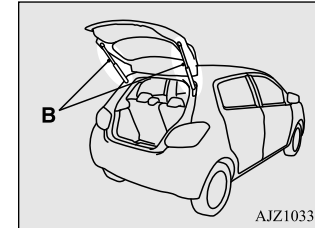

To prevent damage or faulty operation,

- Do not hold the gas struts when closing the tailgate.
- Also, do not push or pull the gas struts.
- Do not attach any plastic material, tape, etc., to the gas struts.
- Do not tie string, etc., around the gas struts.
- Do not hang any object on the gas struts.

Electric window control

E00302201762

The electric windows can only be operated with the ignition switch or the operation mode in ON.

Electric window control switch

E00302303477

Each door window opens or closes while the corresponding switch is operated.

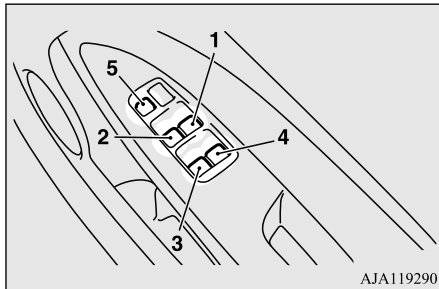

AJA119290

- 1- Driver's door window
- 2- Front passenger's door window
- 3- Rear left door window
- 4- Rear right door window
- 5- Lock switch

WARNING

- Before operating the electric window control, make sure that nothing is capable of being trapped (head, hand, finger, etc.).
- Never leave the vehicle without removing the key.
- Never leave a child (or other person who might not be capable of safe operation of the electric window control) in the vehicle alone.

Driver's switches

The driver's switches can be used to operate all door windows. A window can be opened or closed by operating the corresponding switch.

Press the switch down to open the window, and pull up the switch to close it.

If the switch for the driver's window is fully pressed down/pulled up, the door window automatically opens/closes completely.

If you want to stop the window movement, operate the switch lightly in the reverse direction.

Passenger's switches

The passenger's switches can be used to operate the corresponding passenger's door windows.

Press the switch down for opening the window, and pull up the switch for closing.

3

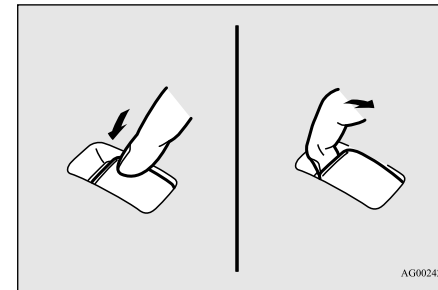

AG0024231

NOTE

- Repeated operation with the engine stopped will run down the battery. Operate the window switches only while the engine is running.
- The rear door windows only open halfway.

Electric window control

Lock switch

E00303102606

3

When this switch is operated, the passenger's switches cannot be used to open or close the door windows and the driver's switch cannot open or close any door windows other than the driver's door window.

To unlock, press it once again.

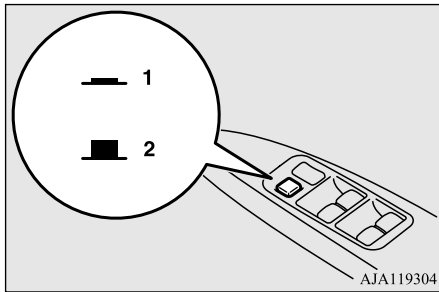

- 1- Lock
- 2- Unlock

WARNING

- A child may tamper with the switch at the risk of its hands or head being trapped in the window. When driving with a child in the vehicle, please press the window lock switch to disable the passenger's switches.

Timer function

E00302402237

The door windows can be opened or closed for 30 seconds after the engine is stopped. However, once the driver's door or the front passenger's door is opened, the windows cannot be operated.

Safety mechanism (driver's window only)

E00302502270

When the door window is automatically closed by pulling up the switch fully, if a hand or head is trapped in the closing window, it will lower automatically.

Nonetheless, make sure that nobody puts their head or hand out of the window when closing the driver's door window.

The lowered window will become operational after a few seconds.

WARNING

- If the battery terminals are disconnected or the fuse for electric window is replaced, the safety mechanism will be cancelled. If a hand or head got trapped, a serious injury could result.

CAUTION

- The safety mechanism is cancelled just before the window is fully closed. This allows the window to close completely. Therefore be especially careful that no fingers are trapped in the window.
- The safety mechanism is deactivated while the switch is pulled up. Therefore be especially careful that fingers are not trapped in the door window opening.

NOTE

- The safety mechanism can be activated if the driving conditions or other circumstances cause the driver's door window to be subjected to a physical shock similar to that caused by a trapped hand or head.
- If the safety mechanism is activated 5 or more times in a row, the safety mechanism will be cancelled and the door window will not close correctly. In such a case, the following procedure should be implemented to rectify this situation. If the window is open, repeatedly raise the driver's door window switch until that window has been fully closed. Following this, release the switch, raise the switch once again and hold it in this condition for at least 1 second, then release it. You should now be able to operate in the normal fashion.

 **NOTE**

- If the battery terminals are disconnected or the fuse for electric window is replaced, the safety mechanism will be cancelled and the door window will not automatically open/close completely.

If the window is open, repeatedly raise the driver's door window switch until the window has been fully closed. Following this, release the switch, raise the switch once again and hold it in this condition for at least 1 second, then release it. You should now be able to operate the driver's door window in the normal fashion.



Seat and seat belts

Seat adjustment	4-2
Front seat	4-2
Rear seat	4-3
Head restraints	4-3
Seat belts	4-5
Pregnant women restraint	4-7
Seat belt pre-tensioner system and force limiter system	4-8
Child restraint	4-8
Seat belt inspection	4-13
Supplemental restraint system (SRS) - airbag	4-13

Seat adjustment

Seat adjustment

E00400302174

Adjust the driver's seat so that you are comfortable and that you can reach the pedals, steering wheel, switches etc. while retaining a clear field of vision.

4

! WARNING

- Do not attempt to adjust the seat while driving. This can cause loss of vehicle control and result in an accident. After adjustments are made, ensure the seating is locked in position by attempting to move the seat forward and rearward without using the adjusting mechanism.
- Do not allow people or children to ride in any area of your vehicle that is not equipped with seats and seat belts, and make sure that everyone travelling in your vehicle is in a seat and wearing a seat belt, or in the case of a child is strapped in a child restraint.
- To minimize the risk of personal injury in the event of a collision or sudden braking, the seatbacks should always be in the almost upright position while the vehicle is in motion. The protection provided by the seat belts may be reduced significantly when the seatback is reclined. There is greater risk that the passenger will slide under the seat belt, resulting in serious injury, when the seatback is reclined.

! WARNING

- Do not place objects under the seats. This could prevent the seat from locking securely, and it could lead to an accident. It may also cause damage to the seat or other parts.

! CAUTION

- Make sure the seat is adjusted by an adult or with adult supervision for correct and safe operation.
- Do not place a cushion or the like between your back and the seatback while driving. The effectiveness of the head restraints will be reduced in the event of an accident.
- When sliding the seats, be careful not to catch your hand or foot.

Front seat

E00400400201

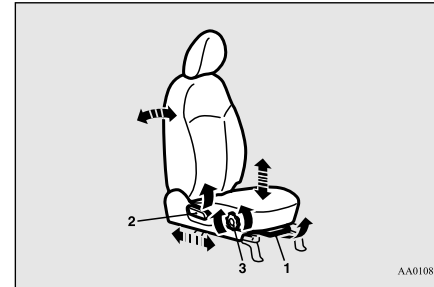

- 1- To adjust forward or backward
Lift the handle and adjust the seat to the desired position, and release the handle.
- 2- To recline the seatback
Pull the lever up and then lean backward to the desired position, and release the lever.
- 3- To adjust seat cushion height (driver's side only)
Turn the dial and adjust the seat cushion height to the desired position.

CAUTION

- The reclining mechanism of the seatback is spring loaded, causing it to return to the vertical position when the lock lever is operated. When using the lever, sit close to the seatback or hold it with your hand to control its return motion.

Armrest (Driver's seat only)*

E00400901548

To adjust the armrest angle, tip the armrest forward and then raise it to the desired position.

To release the armrest angle, raise it fully rearward as shown.

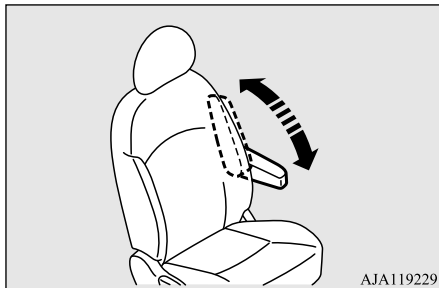
**NOTE**

- Do not stand or sit on the armrest. It could break.

Rear seat

E00401300018

Folding the seatbacks forward

E00401601483

The passenger and luggage compartments can be joined by folding the rear seatback forward. This is useful for carrying long objects.

To fold

1. Place each head restraint in its lowest position. (Refer to "Head restraints" on page 4-3.)
2. Pull the left and/or right release bands (A), and fold the rear seatbacks forward.

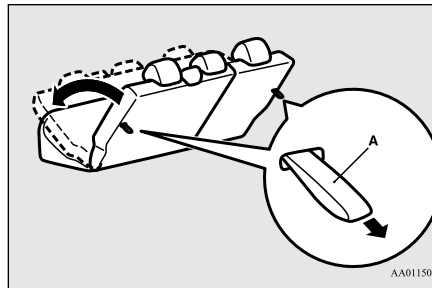

3. Store the seat belt plate of the outboard seating position. (Refer to "Rear seat belt storage" on page 4-7.)

To return

1. Confirm that the seat belt plate of the outboard seating position is stored.
2. Raise the seatbacks until it locks securely into place.
Push lightly on the seatbacks to confirm that it has actually been secured.

4**Head restraints**

E00403302973

WARNING

- **Driving without the head restraints in place can cause you and your passengers serious injury or death in an accident. To reduce the risk of injury in an accident, always make sure the head restraints are installed and properly positioned when the seat is occupied.**
- **Never place a cushion or similar device on the seatback. This can adversely affect head restraint performance by increasing the distance between your head and the restraint.**
- **When a person sits in the rear seat, pull up the head restraint to a height at which it locks in position. Be sure to make this adjustment before starting to drive. Serious injuries could otherwise be suffered in the result of an impact.**

Head restraints

4

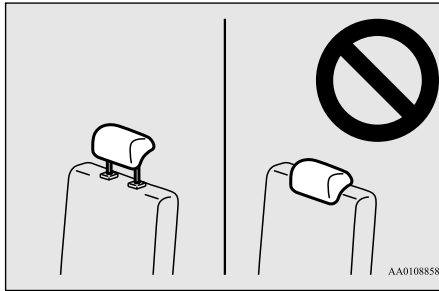

To adjust height

Adjust the head restraint height so that the centre of the restraint is as close as possible to eye level to reduce the chances of injury in the event of collision. Any person too tall for the restraint to reach their seated eye level, should adjust the restraint as high as possible. To raise the head restraint, move it upward. To lower the restraint, move it downward while pushing the height adjusting knob (A) in the direction of the arrow. After adjustment, push the head restraint downward and make sure that it is locked.

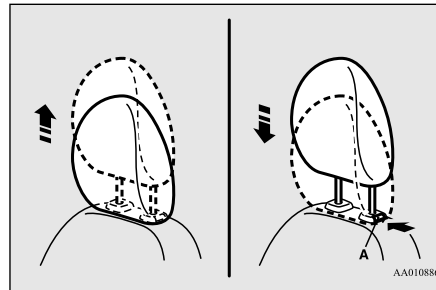

To remove

Lift the head restraint with the height adjusting knob (A) pushed in.

To install

Confirm that the head restraint is facing the correct direction, and then insert it into the seatback while pressing the height adjusting knob (A) in the direction indicated by the arrow.

The head restraint stalk with the adjustment notches (B) must be installed in the hole with the adjusting knob (A).

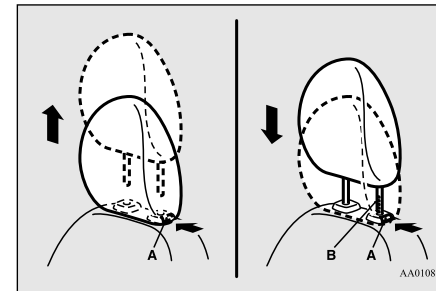

CAUTION

- Confirm that the height adjusting knob (A) is correctly adjusted as shown in the illustration, and also lift the head restraints to ensure that they do not come out of the seatback.

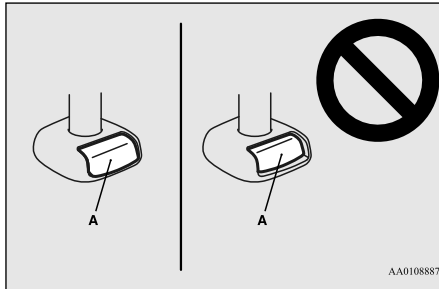

CAUTION

- The shape and size of the head restraint differs according to the seat. Always use the correct head restraint provided for the seat and do not install the head restraint in the wrong direction.

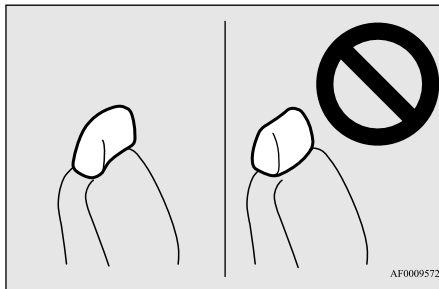

Seat belts

E00404800883

To protect you and your passengers in the event of an accident, it is the most important that the seat belts be worn correctly while driving.

The front seat belt have a pre-tensioner system.

These belts are used the same way as a conventional seat belt.

Refer to “Seat belt pre-tensioner system and force limiter system” on page 4-8.

WARNING

- Seat belts should always be worn by every adult who drives or rides in this vehicle, and by all children who are large enough to wear seat belts properly. Other children should always use proper child restraint systems.
- Always place the shoulder belt over your shoulder and across your chest. Never put it behind you or under your arm.
- One seat belt should be used by only one person. Doing otherwise can be dangerous.

WARNING

- The seat belt will provide its wearer with maximum protection if the recliner seatback is placed in fully upright position. When the seatback is reclined, there is greater risk that the passenger will slide under the belt, especially in a forward impact accident, and may be injured by the belt or by striking the instrument panel or seatbacks.
- Remove any twists when using the belt.
- No modifications or additions should be made by the user which will either prevent the seat belt adjusting devices from operating to remove slack, or prevent the seat belt assembly from being adjusted to remove slack.
- Never hold a child in your arms or on your lap when riding in this vehicle, even if you are wearing your seat belt. To do so risks severe or fatal injury to your child in a collision or sudden stop.
- Always adjust the belt to a snug fit.
- Always wear the lap portion of the belt over your hips.

4

3-point type seat belt (with emergency locking mechanism)

E00404903250

This type of belt requires no length adjustment. Once worn, the belt adjusts itself to the movement of wearer, but in the event of a

Seat belts

sudden or strong shock, the belt automatically locks to hold the wearer's body.

NOTE

- You can check if the belt locks by pulling it forward quickly.

4

To fasten

1. Pull the seat belt out slowly while holding the latch plate.

NOTE

- When the seat belts cannot be pulled out in a locked condition, pull the belts once forcefully and then return them. After that, pull the belts out slowly once again.

2. Insert the latch plate into the buckle until a “click” is heard.

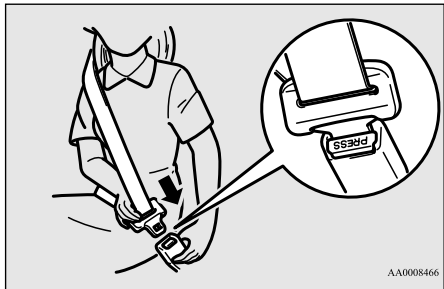

WARNING

- Never wear the lap portion of the belt across your abdomen. During accidents it can press sharply against abdomen and increase the risk of injury.
- The seat belts must not be twisted when worn.

3. Pull the belt slightly to adjust slackness as desired.

To unfasten

Hold the latch plate and push the button on the buckle.

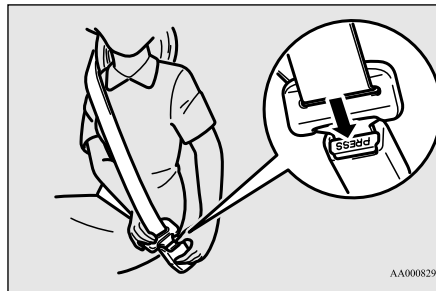

NOTE

- As the belt retracts automatically, keep the latch plate held while retracting so that the belt stows slowly. Failure to do this could damage the vehicle.
- If the seat belt (A) or ring (B) becomes dirty, the belt may not retract smoothly. If the seat belt and ring are dirty, clean them with a mild soap or detergent solution.

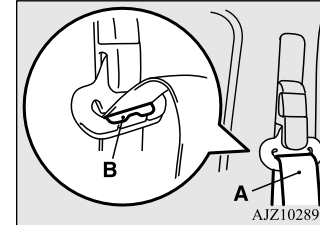

Adjustable seat belt anchor (front seats)

E00405001791

The seat belt anchor height can be adjusted. To move the anchor, pull the lock knob (A) and slide the anchor to the desired position. Release the lock knob to lock the anchor into position.

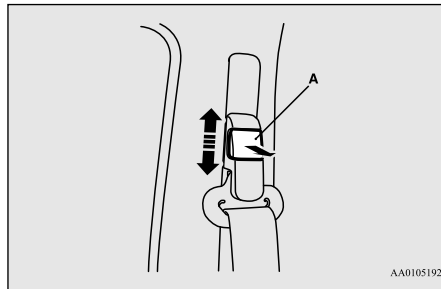

⚠️ WARNING

- When adjusting the seat belt anchor, set it at a position that is sufficiently high so that the belt will make full contact with your shoulder but will not touch your neck.

Seat belt reminder

E00409802257

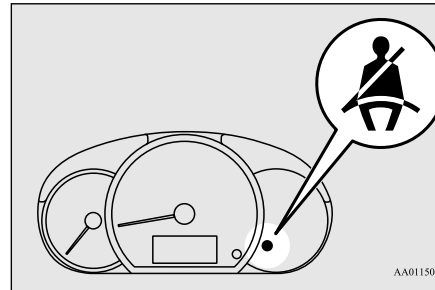

If the ignition switch is turned to the “ON” position or the operation mode is put in ON while the driver’s seat belt is not fastened, the warning lamp comes on and the tone sounds for about 6 seconds to remind the driver to fasten the seat belt.

If the vehicle is driven with the seat belt still unfastened, the warning lamp will blink and the tone will sound intermittently until the seat belt is fastened.

📖 NOTE

- If the seat belt subsequently remains unfastened, the warning lamp and the tone will issue further warnings each time the vehicle starts moving from a stop.

Rear seat belt storage

E00405400059

When folded the rear seatbacks forward, store the seat belts as shown in the illustration.

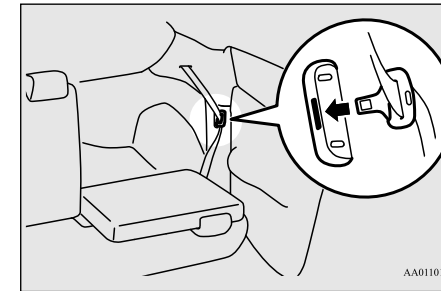

4

Pregnant women restraint

E00405600064

⚠️ WARNING

- Seat belts work for everyone, including pregnant women. Pregnant women should use the available seat belts. This will reduce the likelihood of injury to both the woman and the unborn child. The lap belt should be worn across the thighs and as snug against the hips as possible, but not across the waist. Consult your doctor if you have any additional questions or concerns.

Seat belt pre-tensioner system and force limiter system

E00405701378

4

The driver's seat and front passenger's seat each have a seat belt equipped with a pre-tensioner system and force limiter system.

Pre-tensioner system

E00405802291

When the ignition switch or the operation mode is under the following conditions, if there is a frontal impact severe enough to injure the driver and/or front passenger, the pre-tensioner system will retract their respective seat belts instantaneously, thus maximizing the seat belt's effectiveness.

[Except for vehicles equipped with the keyless operation system]

The ignition switch is in the "ON" or "START" position.

[Vehicles equipped with the keyless operation system]

The operation mode is in ON.

WARNING

- To obtain the best results from your pre-tensioner seat belt, make sure you have adjusted your seat correctly and wear your seat belt properly.

CAUTION

- Any installation of audio equipment or repairs in the vicinity of the pre-tensioner seat belts or floor console must be performed by an authorised MITSUBISHI MOTORS dealer. It is important to do so because the work could affect the pre-tensioner systems.
- If you need to scrap the vehicle, please consult an authorised MITSUBISHI MOTORS dealer. It is important to do so because unexpected activation of the pre-tensioner seat belts could cause injuries.

NOTE

- The pre-tensioner seat belts will be activated if the vehicle suffers a severe frontal impact, even if the seat belts are not worn.
- The pre-tensioner seat belts are designed to work only once. After the pre-tensioner seat belts have been activated, they must be replaced by an authorised MITSUBISHI MOTORS dealer.

SRS warning lamp

E00405900083

This warning lamp is shared by the SRS airbags and the pre-tensioner seat belts.

Refer to "SRS warning lamp" on page 4-18.

Force limiter system

E00406000153

In the event of a collision, each force limiter system will effectively absorb the load applied to the seat belt to minimize the impact to the passenger.

Child restraint

E00406401835

When transporting children in your vehicle, some type of child restraint system should always be used according to the size of the child. This is required by law in most countries.

The regulations concerning driving with children in the front seat may differ from country to country. You are advised to comply with the relevant regulations.

WARNING

- When possible, put children in the rear seat. Accident statistics indicate that children of all sizes and ages are safer when properly restrained in the rear seat rather than in the front seat.
- Holding a child in your arms is no substitute for a restraint system. Failure to use a proper restraint system can result in severe or fatal injury to your child.
- Each child restraint device or fixing is to be used only by one child.

⚠ WARNING

- When attaching a child restraint system to the rear seat, prevent the front seatbacks from touching the child restraint system. Otherwise, the child could be seriously injured in the event of hard braking or a collision.

Caution for installing the child restraint on vehicle with front passenger's airbag

E00406501748

The label shown here is attached on vehicles with front passenger's airbag.

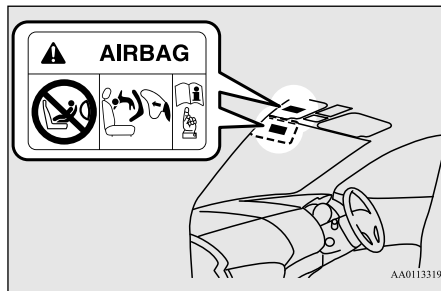

AA0113319

⚠ WARNING

- **Extreme Hazard!**
NEVER use a rearward facing child restraint on a seat protected by an ACTIVE AIRBAG in front of it, DEATH or SERIOUS INJURY to the CHILD can occur.
- A REARWARD FACING CHILD RESTRAINT must NOT be used in the front passenger seat as it places an infant too close to the passenger's airbag. The force of an inflating airbag could kill or cause serious injuries to the child. A rearward facing child restraint must only be used in the rear seat.



AJA102924

⚠ WARNING

- A FORWARD FACING CHILD RESTRAINT should be used in the rear seat whenever possible; if it must be used in the front passenger seat, adjust the seat to the most rearward position. Failure to do so could kill or cause serious injuries to the child.

Infants and small children

E00406600553

When transporting infants and small children in your vehicle, follow the instruction given below.

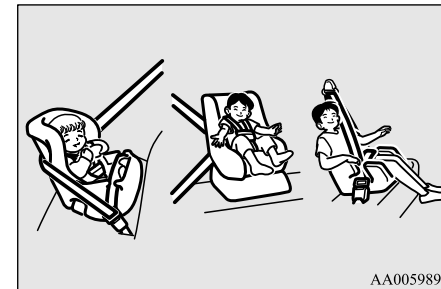

AA0059891

4

Instruction:

- For small infants, an infant carrier should be used. For small children whose height when seated allows the shoulder belt to lie in contact with the face or the throat, a child seat should be used.
- The child restraint system should be appropriate for your child's weight and height and properly fit the vehicle. For a higher degree of safety: **THE CHILD RESTRAINT SYSTEM SHOULD BE INSTALLED IN THE REAR SEAT.**
- Before purchasing a child restraint system, try installing it in the rear seat to make sure there is a good fit. Because of the location of the seat belt buckles and the shape of the seat cushion, it may be difficult to securely install some manufacturer's child restraint systems. If the child restraint system can be pulled forward or to either side easily on the seat cushion after the seat belt has been tightened, choose another manufacturer's child restraint system.

! WARNING

- When installing a child restraint system, refer to the instructions provided by the manufacturer of the restraint system. Failure to do so can result in severe or fatal injury to your child.

! WARNING

- After installation, push and pull the child restraint system back and forth, and side to side, to see that it is positively secured. If the child restraint system is not installed securely, it may cause injury to the child or other occupants in the case of accident or sudden stops.
- When the child restraint system is not in use, keep your child restraint system secured with the seat belt or remove it from the vehicle in order to prevent it from being thrown around inside the vehicle during an accident.

Older children

Children who have outgrown the child restraint system should be seated in the rear seat and wear combination lap shoulder belt. The lap portion of the belt should be snug and positioned low on the abdomen so that it is below the top of the hip-bone. Otherwise, the belt could intrude into the child's abdomen during an accident and cause injury.

Installing a child restraint system to the lower anchorage (ISOFIX child restraint mountings) and tether anchorage

E00408902684

Lower anchorage location

Your vehicle's rear seat is fitted with lower anchorages for attaching a child restraint system with ISOFIX mountings.

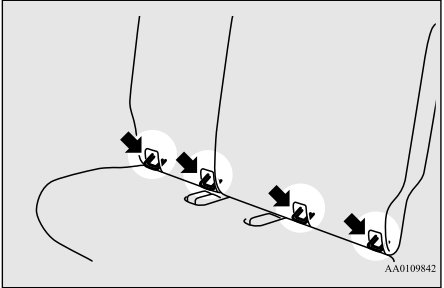

Tether anchorage locations

There are 2 attachment points located on the back of the rear seatbacks. These are for securing a child restraint system tether strap to each of the 2 rear seating positions in your vehicle.

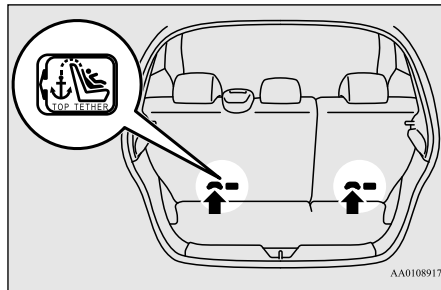

WARNING

- Child restraint anchorages are designed to withstand only those loads imposed by correctly fitted child restraints. Under no circumstances are they to be used for adult seatbelts, harnesses or for attaching other items or equipment to the vehicle.

Child restraint system with ISO-FIX mountings

The child restraint system is designed only for seats that incorporate lower anchorages. Retain the child restraint system using the lower anchorages.

It is not necessary to retain the child restraint system using the vehicle's seat belts.

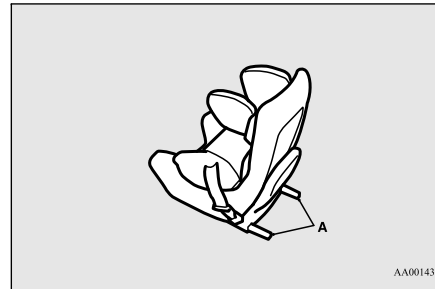

A: Child restraint system connectors

Installation:

1. Remove any foreign material in or around the connectors and ensure the vehicle seat belt is in its normal storage position.

2. Remove the head restraint from the location in which you wish to install a child restraint system.

Refer to "Head restraints" on page 4-3.

CAUTION

- Do not remove the head restraint when installing a booster cushion.

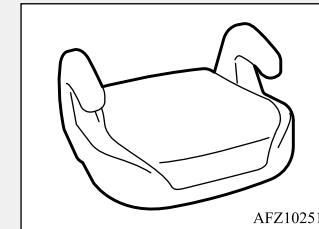

3. Open the gap a little between the seat cushion (A) and the seatback (B) with your hand to locate the lower anchorages (C).

4

Child restraint

4. Push the child restraint system's connectors (D) into the lower anchorages (C) in accordance with the instructions provided by the child restraint system's manufacturer.

4

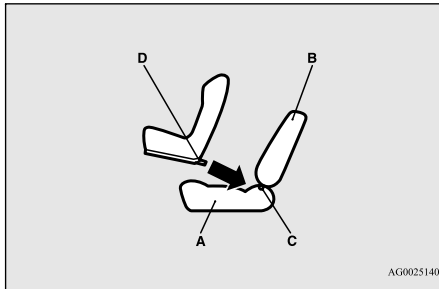

- A: Vehicle seat cushion
B: Vehicle seatback
C: Lower anchorage
D: Connector

If your child restraint system requires the use of a tether strap, fasten the tether strap in accordance with step 5.

5. Latch the top tether strap hook (E) of the child restraint system to the tether anchor bracket (F) and tighten the top tether strap so it is securely fastened.

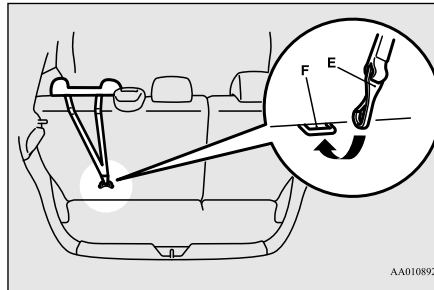

6. Push and pull the child restraint system in all directions to be sure it is firmly secured.

Installing a child restraint system to a 3-point type seat belt (with emergency locking mechanism)

E00407102197

Installation:

1. Put a child restraint system on the seat in which you wish to install it, and remove the head restraint from the seat. Refer to "Head restraints" on page 4-3.

CAUTION

- Do not remove the head restraint when installing a booster cushion.

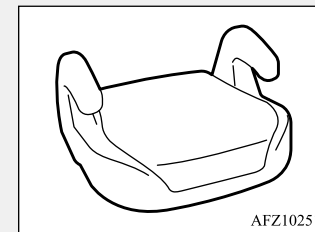

2. Route the belt through the child restraint according to the child restraint system manufacturer's instructions, then insert the latch plate into the buckle.
3. Remove all slack by using the locking clip.

- Before putting the child in the restraint, push and pull the restraint in all directions to be sure it is secure. Do this before each use.

⚠ WARNING

- For some types of child restraint, the locking clip (A) should be used to help avoid personal injury during a collision or sudden manoeuvre. It must be fitted and used in accordance with the child restraint manufacturer's instructions. The locking clip must be removed when the child restraint is removed.

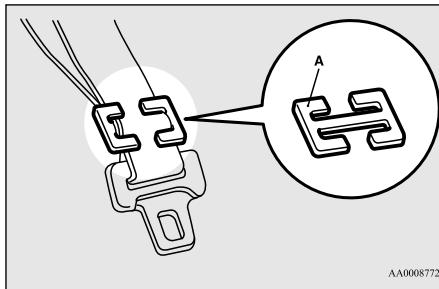

Seat belt inspection

E00406301977

Check the belts for cuts, worn or frayed webbing and for cracked or deformed metallic parts. Replace the belt assembly if defective.

⚠ WARNING

- All seat belt assemblies including retractors and attaching hardware should be inspected by an authorised MITSUBISHI MOTORS dealer after any collision. We recommend that seat belt assemblies in use during a collision be replaced unless the collision was minor and the belts show no damage and continue to operate properly.
- Do not attempt to repair or replace any part of the seat belt assemblies; this work should be done by an authorised MITSUBISHI MOTORS dealer. Failure to have an authorised MITSUBISHI MOTORS dealer perform the work could reduce the effectiveness of the belts and could result in serious injury in the event of a collision.
- Once the pre-tensioner has activated, it cannot be re-used. It must be replaced together with the retractor.

⚠ WARNING

- Do not insert any foreign objects (pieces of plastic, paper clips, buttons, etc.) in the buckle or retractor mechanism. In addition, do not modify, remove, or install the seat belt. Otherwise, the seat belt may not be able to provide adequate protection in a collision or other situation.

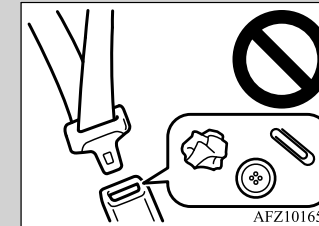

- A dirty belt should be cleaned with neutral detergent in warm water. After rinsing in water, let it dry in the shade. Do not attempt to bleach or re-dye the belts because this affects their characteristics.

Supplemental restraint system (SRS) - airbag

E00407203528

The information written in this supplemental restraint system (SRS) section contains important points concerning the driver's and front passenger's airbags.

The SRS driver's and front passenger's airbags are designed to supplement the primary

Supplemental restraint system (SRS) - airbag

protection of the driver and front passenger side seat belt systems by providing those occupants with protection against head and chest injuries in certain moderate-to-severe frontal collisions.

4

The SRS is NOT a substitute for the seat belts; for maximum protection in all types of crashes and accidents, seat belts should ALWAYS be worn by everyone who drives or rides in this vehicle.

How the supplemental restraint system works

E00407301671

The SRS includes the following components:

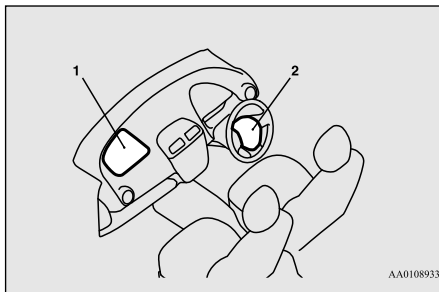

AA0108933

- 1- Airbag module (Passenger)
- 2- Airbag module (Driver)

Only when the ignition switch or the operation mode is under the following conditions, the airbags will operate.

[Except for vehicles equipped with the keyless operation system]

The ignition switch is in the “ON” or “START” position.

[Vehicles equipped with the keyless operation system]

The operation mode is in ON.

The airbags deployment produces a sudden, loud noise, and releases some smoke and powder, but these conditions are not injurious, and do not indicate a fire in the vehicle. People with respiratory problems may feel some temporary irritation from chemicals used to produce the deployment; open the windows after airbag deployment, if safe to do so.

The airbags deflate very rapidly after deployment, so there is little danger of obscured vision.

CAUTION

- Airbags inflate at an extremely rapid speed. In certain situations, contact with inflating airbags can result in abrasions, light cuts, bruises, and the like.

WARNING

- **IT IS VERY IMPORTANT TO BE PROPERLY SEATED.**

A driver or front passenger too close to the steering wheel or instrument panel during airbag deployment can be killed or seriously injured.

Airbags inflate very fast, and with great force.

If the driver and passengers are not properly seated and restrained, the airbags may not protect you properly, and could cause serious or fatal injuries when it inflates.

- Do not sit on the edge of the seat, or lean head or chest close to the steering wheel or instrument panel. Do not put feet or legs on or against the instrument panel.
- Place all infants and small children in the rear seat and properly restrained using an appropriate child restraint system. The rear seat is the safest for infants and children.

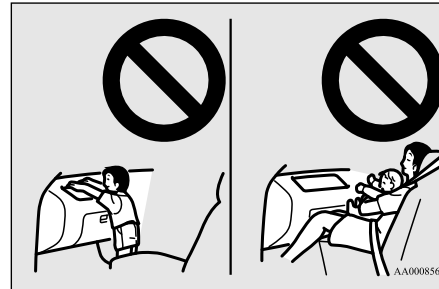
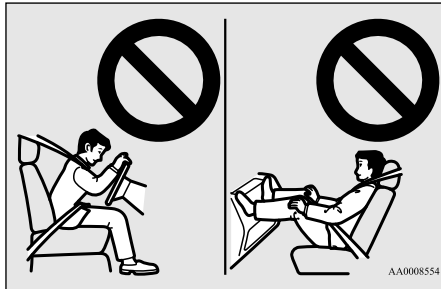

⚠ WARNING

- Infants and small children should never be unrestrained, stand up against the instrument panel or held in your arms or on your lap. They could be seriously injured or killed in a collision, including when the airbag inflates. They should be properly seated in the rear seat in an appropriate child restraint system. See the “Child restraint” section of this owner’s manual.

⚠ WARNING

- Older children should be seated in the rear seat, properly wearing the seat belt, with an appropriate booster seat if needed.

Caution for installing the child restraint on vehicle with front passenger’s airbag

E00408802061

The label shown here is attached on vehicles with front passenger’s airbag.

⚠ WARNING

- **Extreme Hazard!**
NEVER use a rearward facing child restraint on a seat protected by an ACTIVE AIRBAG in front of it, DEATH or SERIOUS INJURY to the CHILD can occur.

Driver’s and passenger’s front airbag system

E00407400851

The driver’s airbag is located under the padded cover in the middle of the steering wheel. The front passenger’s airbag is contained in the instrument panel above the glove box. The front passenger’s airbag deploys at the same time as the driver’s airbag, even if the passenger seat is not occupied.

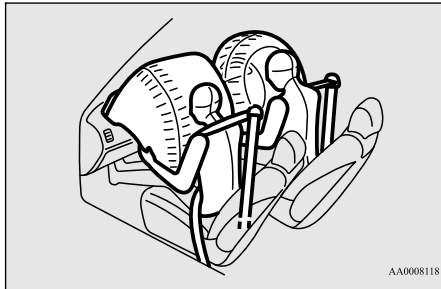

Deployment of front airbags

E00412500300

The front airbags ARE DESIGNED TO DEPLOY when...

The front airbags are designed to deploy when the vehicle suffers a moderate to severe frontal impact. A typical condition is shown in the illustration.

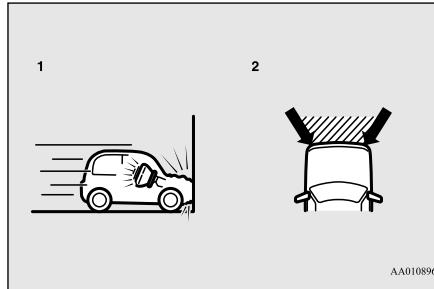

- 1- Head-on collision with a solid wall at speed of approximately 25 km/h or higher
- 2- Moderate to severe frontal impact within the shaded area between the arrows

The front airbags will deploy if the severity of impact is above the designed threshold level, comparable to an approximately 25 km/h collision when impacting straight into a solid wall that does not move or deform. If the severity of the impact is below the above threshold level, the front airbags may not deploy. However, this threshold speed will be considerably higher if the vehicle strikes an object that absorbs the impact by either deforming or moving (for example, another stationary vehicle, pole or a guard rail).

Because frontal collisions can easily move you out of position, it is important to always

properly wear your seat belts. Your seat belts will help keep you in a safe distance from the steering wheel and instrument panel during the initial stages of airbag deployment. The initial stage of airbag inflation is the most forceful, and can possibly cause serious or fatal injuries. Moreover, the seat belts in your vehicle are your primary means of protection in a collision. The SRS airbags are designed to provide additional protection. Therefore, for your safety and the safety of all occupants, be sure to always properly wear your seat belts.

The front airbags MAY NOT DEPLOY when...

With certain types of frontal collisions, the vehicle's body structure is designed to absorb the shock to help protect the occupants from harm. (The vehicle body's front area may deform significantly as it absorbs the impact.) Under such circumstances, the front airbags may not deploy irrespective of the deformation and damage to the vehicle body.

Examples of some typical conditions are shown in the illustration.

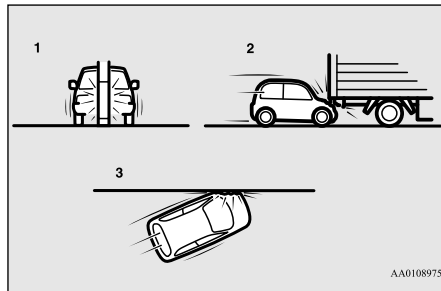

- 1- Collision with a utility pole, tree or other narrow objects
- 2- Vehicle slides under the rear body of a truck
- 3- Oblique frontal impacts

Because the front airbags do not protect the occupant in all types of frontal collisions, be sure to always properly wear your seat belts.

The front airbags ARE NOT DESIGNED TO DEPLOY when...

The front airbags are not designed to deploy in conditions where they cannot typically provide protection to the occupant. Such conditions are shown in the illustration.

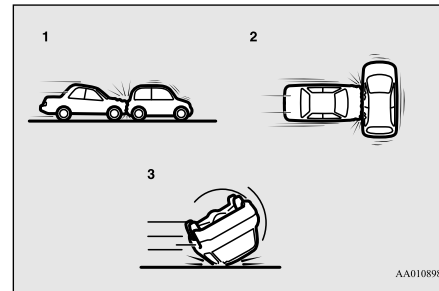

- 1- Rear end collisions
- 2- Side collisions
- 3- Vehicle rolls onto its side or roof

Because the front airbags do not protect the occupant in all types of collisions, be sure to always properly wear your seat belts.

The front airbags MAY DEPLOY when...

The front airbags may deploy if the bottom of the vehicle suffers a moderate to severe impact (undercarriage damage). Examples of some typical conditions are shown in the illustration.

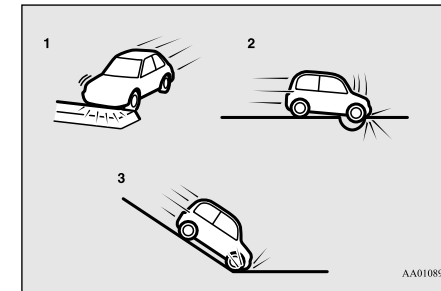

- 1- Collision with an elevated median/island or kerb
- 2- Vehicle travels over a deep hole/pothole
- 3- Vehicle drives down a steep slope and hits the ground

Because the front airbags may deploy in certain types of unexpected impacts as shown in the illustration that can easily move you out of position, it is important to always properly wear your seat belts. Your seat belts will help keep you in a safe distance from the steering wheel and instrument panel during the initial stages of airbag deployment. The initial stage of airbag inflation is the most forceful and can possibly cause serious or fatal injuries if you contact it at this stage.

Supplemental restraint system (SRS) - airbag

4

⚠ WARNING

- Do not attach anything to the steering wheel padded cover, such as trim material, badges, etc. It might strike and injure an occupant if the airbag inflates.
- Do not set anything on, or attach anything to, the instrument panel above the glove box. It might strike and injure an occupant if the airbag inflates.

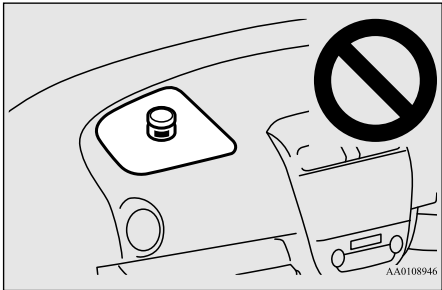

⚠ WARNING

- Do not attach accessories to, or put them in front of, the windscreen. These objects could restrict the airbag inflation, or strike and injure an occupant if the airbags inflate.
- Do not put packages, pets or other objects between the airbags and the driver or front passenger. It could affect airbag performance, or could cause injury when the airbag inflates.

⚠ WARNING

- Right after the airbag inflation, several airbag system components will be hot. Do not touch them; you could be burned.
- The airbag system is designed to work only once. Once the airbags have deployed, they will not work again. They must promptly be replaced and the entire airbag system must be inspected by an authorised MITSUBISHI MOTORS dealer.

SRS warning lamp

E00407802918

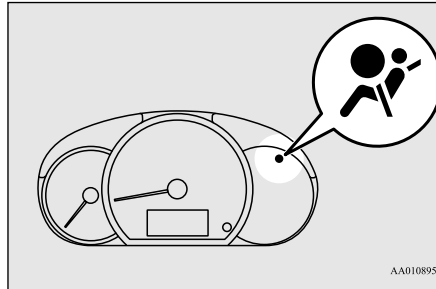

There is a supplemental restraint system (“SRS”) warning lamp on the instrument panel. The system checks itself every time the ignition switch is turned to the “ON” position or the operation mode is put in ON. The SRS warning lamp will come on for several sec-

onds and then go out. This in normal and means the system is working properly.

If there is a problem involving one or more of the SRS components, the warning lamp will come on and stay on.

The SRS warning lamp is shared by the SRS airbag and the seat belt pre-tensioner system.

⚠ WARNING

- If any of the following conditions occur, there may be a problem with the SRS airbags and/or seat belt pre-tensioners, and they may not function properly in a collision or may suddenly activate without a collision:
 - Even when the ignition switch or the operation mode is in ON, the SRS warning lamp does not come on or it remains on.
 - The SRS warning lamp comes on while driving.The SRS airbags and seat belt pre-tensioners are designed to help reduce the risk of serious injury or death in certain collisions.
If either of the above conditions occurs, immediately have your vehicle checked by an authorised MITSUBISHI MOTORS dealer.

SRS servicing

E00407901592

⚠ WARNING

- Any maintenance performed on or near the components of the SRS must be performed only by an authorised MITSUBISHI MOTORS dealer. Do not permit anyone else to do service, inspection, maintenance or repair on any SRS components or wiring; similarly, no part of the SRS should ever be handled or disposed of by anyone except an authorised MITSUBISHI MOTORS dealer.

Improper work on the SRS components or wiring could result in inadvertent deployment of the airbags, or could render the SRS inoperative; either situation could result in serious injury.

- Do not modify your steering wheel, seat belt retractor or any other SRS components. For example, replacement of the steering wheel, or modifications to the front bumper or body structure can adversely affect SRS performance and lead to possible injury.
- If your vehicle has received any damage, you should have the SRS inspected by an authorised MITSUBISHI MOTORS dealer to ensure it is in proper working order.

⚠ WARNING

- If you found any tear scratch, crack or damage to the portion of the airbags, you should have the SRS inspected by an authorised MITSUBISHI MOTORS dealer.

📖 NOTE

- If your vehicle has to be scrapped, do this in line with local legislation and contact an authorised MITSUBISHI MOTORS dealer to safely dismantle the airbag system.



Instruments and controls

Instruments	5-2
Multi-information display	5-2
Indicator and warning lamps	5-11
Indicator lamps	5-12
Warning lamps	5-13
Combination headlamps and dipper switch	5-16
Turn-signal lever	5-19
Hazard warning flasher switch	5-20
Front fog lamp switch*	5-20
Wiper and washer switch	5-21
Rear window demister switch	5-23
Horn switch	5-24

Instruments

E00500102753

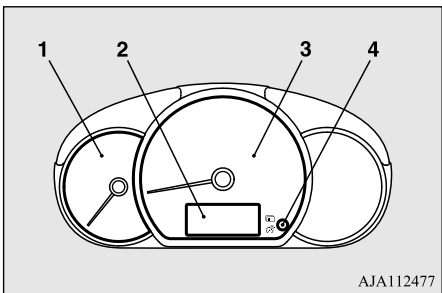

AJA112477

- 1- Tachometer
The tachometer indicates the engine speed (r/min). The tachometer can help you obtain more economical driving and also warns you of excessive engine speeds (Red zone).
- 2- Multi-information display → P.5-2
- 3- Speedometer
The speedometer indicates the vehicle's speed in kilometers per hour (km/h).
- 4- Multi-information display switch

CAUTION

- When driving, watch the tachometer to make sure that the engine speed indication does not rise into the red zone (excessive engine rpm).

AJZ102567

Multi-information display

E00519903581

Always stop the vehicle in a safe place before operating.
The following information is included on the multi-information display: odometer, tripmeter, meter illumination control, service reminder, fuel remaining, selector lever position, driving range, average fuel consumption, etc.

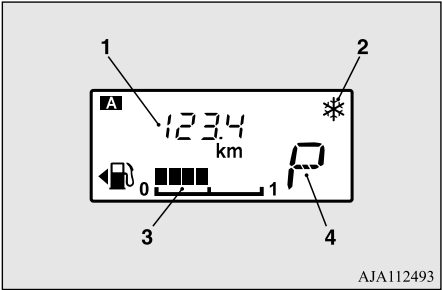

AJA112493

- 1- Information display → P.5-3
- 2- Frozen road warning → P.5-6
- 3- Fuel remaining display → P.5-6
- 4- Selector lever position display*
→ P.6-26

NOTE

- When the ignition switch or the operation mode is OFF, the selector lever position display, fuel remaining display and frozen road warning are not displayed.

Information display

E00528201599

Each time you lightly press the multi-information display switch (A), the display switches in the following order.

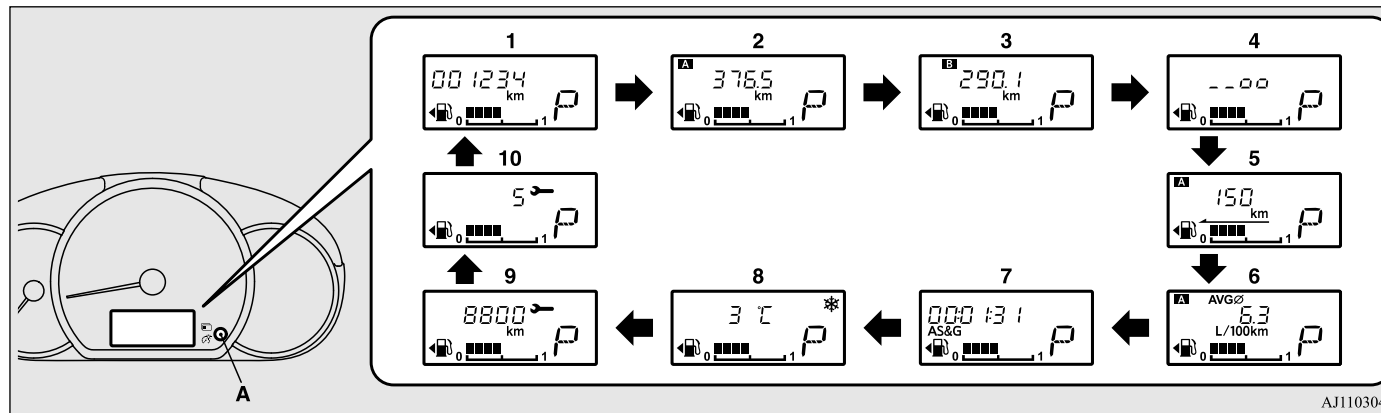

5

AJ1103046

- | | |
|---------------------------------------|--|
| 1- Odometer | 6- Average fuel consumption display |
| 2- Tripmeter A | 7- Auto Stop & Go (AS&G) monitor → P.5-5 |
| 3- Tripmeter B | 8- Outside temperature display → P.5-5 |
| 4- Meter illumination control → P.5-4 | 9- Service reminder (distance) → P.5-7 |
| 5- Driving range display | 10- Service reminder (month) → P.5-7 |

NOTE

- When the ignition switch or the operation mode is OFF, the driving range display, average fuel consumption display and outside temperature display are not displayed.
- While driving, the service reminder is not displayed even if you operate the multi-information display switch.
- When the position lamps are not illuminate, the meter illumination control is not displayed even if you operate the multi-information display switch.

Multi-information display

Odometer

E0052780067

The odometer indicates the distance travelled.

Tripmeter

E0052790042

5

The tripmeter indicates the distance travelled between two points.

Example usage of tripmeter **A** and tripmeter **B**

It is possible to measure two currently travelled distances, from home using tripmeter **A** and from a particular point on the way using tripmeter **B**.

To reset the tripmeter

To return the display to 0, hold down the multi-information display switch for about 1 second or more. Only the currently displayed value will be reset.

Example

If tripmeter **A** is displayed, only tripmeter **A** will be reset.

NOTE

- Both tripmeters **A** and **B** can count up to 9999.9 km. When a tripmeter goes past 9999.9 km, it returns to 0.0 km.
- When disconnecting the battery terminal, the memories of tripmeter display **A** and display **B** are erased, and their displays return to 0.0 km.

Meter illumination control

E00537901114

Turn the position lamps on and press the multi-information display switch (2), there is a sound and the brightness changes.

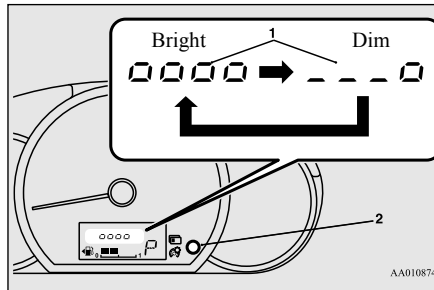

- 1- Brightness level
- 2- Multi-information display switch

NOTE

- When the position lamps are illuminated, you can adjust to 8 levels.
- Each time you reduce two brightness levels, the segment display of the brightness level decreases one by one.
- The brightness level of the instruments is stored when the ignition switch is turned to the "LOCK" position or the operation mode is put in OFF.
- If you press and hold the switch for longer than about 1 second, the brightness automatically scrolls through its different levels, and stops scrolling when you release the switch. Select your desired level of brightness.

Driving range display

E0053800014

This displays the approximate driving range (how many more kilometres or miles you can drive). When the driving range falls below approximately 50 km (30 miles), "---" is displayed.

NOTE

- The driving range is determined based on the fuel consumption data. This may vary depending on the driving conditions and habits. Treat the distance displayed as just a rough guideline.

 **NOTE**

- When you refuel, the driving range display is updated. However, if you only add a small amount of fuel, the correct value will not be displayed. Fill with a full tank whenever possible.
- On rare occasions, the value displayed for the driving range may change if you are parked on an extremely steep incline. This is due to the movement of fuel in the tank and does not indicate any malfunction.
- The display setting can be changed to the preferred units (km or miles). Refer to “Changing the function settings” on page 5-8.

Average fuel consumption display

E00531200017

This displays the average fuel consumption from the last reset to the present time. The reset mode conditions for the average fuel consumption display can be switched between “Auto reset” and “Manual reset”. For information on how to change the average fuel consumption display setting, refer to “Changing the function settings” on page 5-8.

 **NOTE**

- The average fuel consumption display can be reset separately in both auto reset mode and manual reset mode.
- “---” is displayed when the average fuel consumption cannot be measured.
- The initial (default) setting is “Auto reset mode”.
- The average fuel consumption will depend on the driving conditions (road conditions, how you drive, etc.). The displayed fuel consumption may vary from the actual fuel consumption. Treat the fuel consumption displayed as just a rough guideline.
- The memory of the manual reset mode or auto reset mode for the average fuel consumption display is erased if the battery is disconnected.
- The display setting can be changed to the preferred units {km/L, L/100 km, mpg}. Refer to “Changing the function settings” on page 5-8.

Auto Stop & Go (AS&G) monitor

E00531101172

The accumulated time the engine has been stopped by Auto Stop & Go (AS&G) system is displayed. Refer to “Auto Stop & Go (AS&G) system” on page 6-20.

 **NOTE**

- When the ignition switch or the operation mode is ON again, the accumulated time will be reset.

Outside temperature display

E00533501125

5

This displays the temperature outside the vehicle.

 **NOTE**

- The display setting can be changed to the preferred units (°C or °F). Refer to “Changing the function settings” on page 5-8.
- Depending on factors such as the driving conditions, the displayed temperature may vary from the actual outside temperature.

Multi-information display

Frozen road warning

E00533401111

If the outside air temperature drops below approx. 3°C (37 °F), the alarm sounds and the outside air temperature warning symbol (A) flashes for about 10 seconds.

5

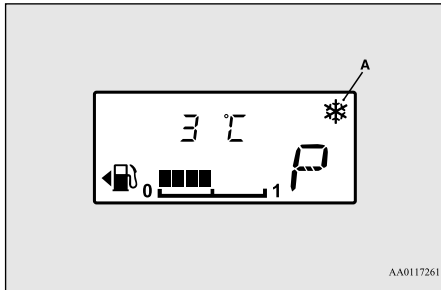

AA0117261

CAUTION

- There is a danger the road might be icy, even when this symbol is not flashing, so please take care when driving.

Fuel remaining display

E00522201571

The fuel remaining display indicates the fuel level in the fuel tank when the ignition switch or the operation mode is ON.

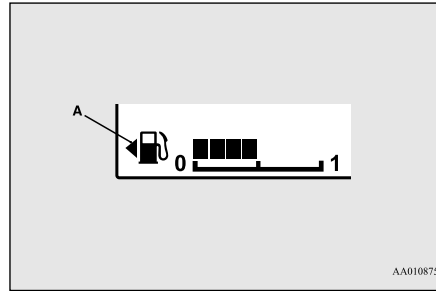

AA0108757

- 1- Full
- 0- Empty

NOTE

- It may take several seconds to stabilise the display after refilling the tank.
- If fuel is added with the ignition switch or the operation mode is ON, the fuel gauge may incorrectly indicate the fuel level.
- The fuel lid mark (A) indicates that the fuel tank filler lid door is located on the left side of the vehicle.

Fuel remaining warning display

E00522402004

If the remaining fuel level is approximately 6 litres or less (one segment displayed) when the ignition switch is turned to the “ON” position or the operation mode is changed to ON, the last segment of the fuel gauge

flashes. If the remaining fuel level is reduced further, the last segment of the fuel gauge goes out, “0” and the bar graph flash.

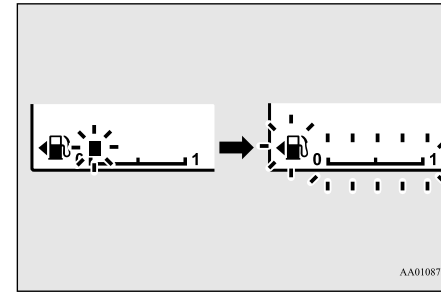

AA0108760

CAUTION

- For vehicles with catalytic converter, do not drive with an extremely low fuel level; running out of fuel could cause damage to the catalytic converter.

NOTE

- On inclines or curves, the display may be incorrect due to the movement of fuel in the tank.

Service reminder

E00522501040

Displays the approximate time until the next periodic inspection that MITSUBISHI MOTORS recommends. “---” is displayed when the inspection time has arrived.

The spanner mark indicates the periodic inspection.

NOTE

- Depending on the vehicle specifications, the displayed time until the next periodic inspection may differ from that of MITSUBISHI MOTORS recommends. In addition, the display settings for the next periodic inspection time can be modified.

To modify the display settings, have it adjusted at an authorised MITSUBISHI MOTORS dealer. For more details, contact an authorised MITSUBISHI MOTORS dealer.

Distance

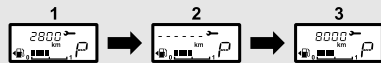

Month



AA0108773

- Displays the time until the next periodic inspection.

NOTE

- The distance is shown in units of 100 km. The time is shown in units of months.

- This informs you that a periodic inspection is due. Please consult an authorised MITSUBISHI MOTORS dealer.
- After your vehicle is inspected at an authorised MITSUBISHI MOTORS dealer, it displays the time until the next periodic inspection.

To reset

The “---” display can be reset while the ignition switch or the operation mode is in OFF.

- When you lightly press the multi-information display switch a few times, the information display switches to the service reminder display.

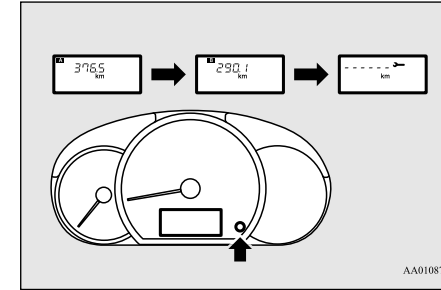

AA0108786

5

- Press and hold the multi-information display switch for about 1 second or more to make the spanner mark start flashing. (If there is no operation for about 10 seconds with flashing, the display will revert to its original indication.)
- Lightly press the multi-information display switch while the icon is flashing to change the display from “---” to “cLEAR”. After this, the time until the next periodic inspection will be displayed.

5

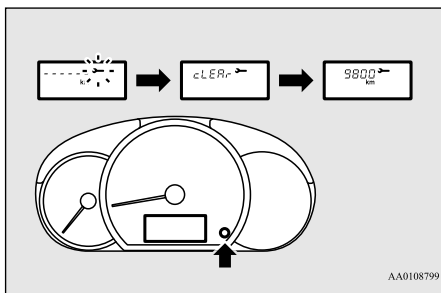

CAUTION

- The customer is responsible for making sure that periodic inspection and maintenance are performed. Inspections and maintenance must be performed to prevent accidents and malfunctions.

NOTE

- “---” display cannot be reset when the ignition switch or the operation mode is ON.
- When “---” is displayed, after a certain distance and a certain period of time, the display is reset and the time until the next periodic inspection is displayed.
- If you accidentally reset the display, consult an authorised MITSUBISHI MOTORS dealer.

Changing the function settings

E00522702007

The average fuel consumption reset mode, fuel consumption unit and temperature unit setting can be modified as desired, when the ignition switch or the operation mode is ON.

CAUTION

- The driver should not operate the display while the vehicle is in motion.
- When operating the system, stop the vehicle in a safe area.

Changing the reset mode for average fuel consumption

E00522902067

The mode conditions for the average fuel consumption display can be switched between “Auto reset” and “Manual reset”.

1. When you lightly press the multi-information display switch a few times, the information display switches to the driving range display. Refer to “Information display” on page 5-3.
2. Each time you press the multi-information display switch for 1 second or more on driving range display, you can switch reset mode for average fuel consumption.

(A: Auto reset mode, B: Manual reset mode)

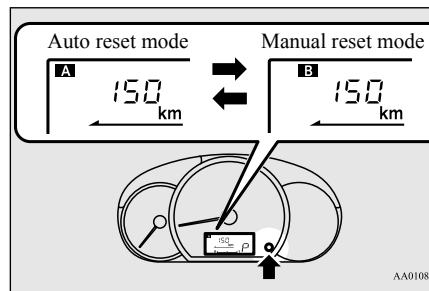

Manual reset mode

- When the average fuel consumption is being displayed, if you hold down the multi-information display switch, the average fuel consumption displayed at that time is reset.
- When the following operation is performed, the mode setting is automatically switched from manual to auto. [Except for vehicles equipped with the keyless operation system] Turn the ignition switch from the “ACC” or “LOCK” position to the “ON” position. [For vehicles equipped with the keyless operation system] Change the operation mode from ACC or OFF to ON.

Switching to auto occurs automatically. If switching to manual mode is done, however, the data from the last reset is displayed.

Auto reset mode

- When the average fuel consumption is being displayed, if you hold down the multi-information display switch, the average fuel consumption displayed at that time are reset.
- When the engine switch or the operation mode is in the following conditions, the average fuel consumption display is automatically reset.

[Except for vehicles equipped with the keyless operation system]

The ignition switch is in the “ACC” or “LOCK” position for about 4 hours or longer.

[For vehicles equipped with the keyless operation system]

The operation mode is in ACC or OFF for about 4 hours or longer.

NOTE

- The average fuel consumption display can be reset separately for the auto reset mode and for the manual reset mode.

NOTE

- The memory of the manual reset mode or auto reset mode for the average fuel consumption display is erased if the battery is disconnected.
- The initial (default) setting is “Auto reset mode”.

Changing the fuel consumption display unit

E00523001781

The display unit for fuel consumption can be switched. The distance and amount units are also switched to match the selected fuel consumption unit.

1. When you lightly press the multi-information display switch a few times, the information display switches to the average fuel consumption display. Refer to “Information display” on page 5-3.
2. Press and hold the multi-information display switch for about 5 seconds or more until buzzer sound is heard twice.
3. Press and hold the multi-information display switch to switch in sequence from “km/L” → “L/100 km” → “mpg” → “km/L”.

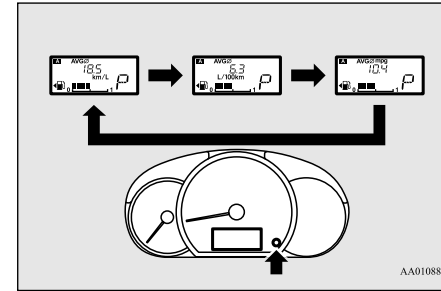

5

NOTE

- The display units for the driving range, the average fuel consumption are switched, but the units for the indicating needle (speedometer), the odometer, the tripmeter and the service reminder will remain unchanged.
- The memory of the unit setting is erased if the battery is disconnected, and it returns automatically to factory setting.

The distance units is also switched in the following combinations to match the selected fuel consumption unit.

Fuel consumption	Distance (driving range)
km/L	km
L/100 km	km
mpg	mile (s)

Multi-information display

Changing the temperature unit

E00523102327

The display unit for outside temperature can be switched.

5

1. When you lightly press the multi-information display switch a few times, the information display switches to the outside temperature display.
Refer to “Information display” on page 5-3.
2. Each time you press the multi-information display switch for about 5 seconds or more on outside temperature display, you can switch from °C to °F or from °F to °C unit of outside temperature display.

NOTE

- The temperature unit on air conditioning panel is switched in conjunction with outside temperature display value of the multi information display.
However, “°C” or “°F” are not shown to temperature display of an air conditioning.

Indicator and warning lamps

E00501504530

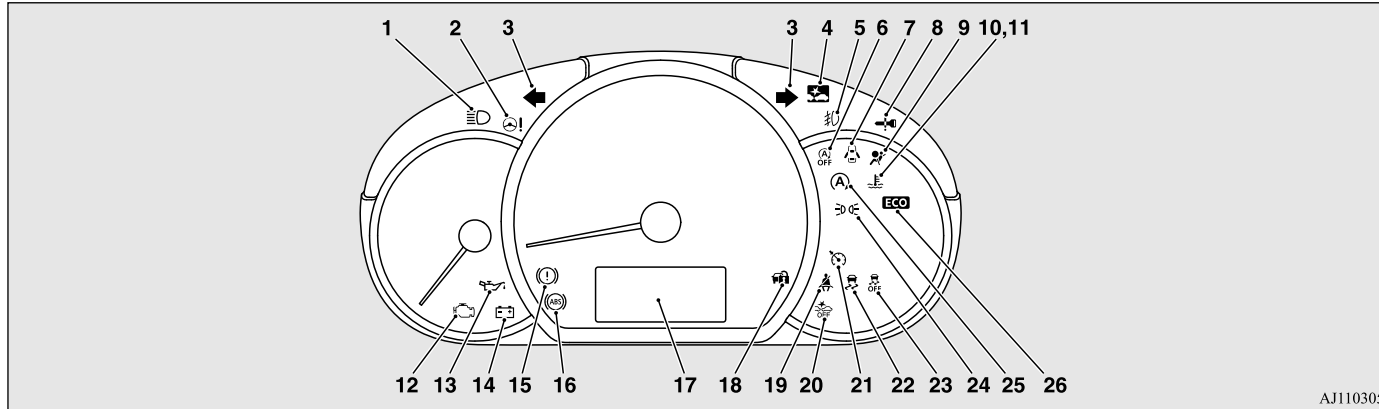

AJ1103059

- | | | |
|---|---|--|
| 1- High-beam indicator lamp → P.5-12 | 7- Door-ajar warning lamp → P.5-15 | 16- Anti-lock brake system (ABS) warning lamp → P.6-34 |
| 2- Electric power steering system (EPS) warning lamp → P.6-35 | 8- For details, refer to “Warning activator” on page 3-11. (if so equipped) | 17- Multi-information display → P.5-2 |
| 3- Turn-signal indicator lamps/Hazard warning indicator lamps → P.5-12 | 9- Supplemental restraint system (SRS) warning lamp → P.4-18 | 18- For details, refer to “Warning activator” on page 3-11. (if so equipped) |
| 4- Forward Collision Mitigation System (Low speed range) (FCM-LS) and Radar sensing misacceleration Mitigation System (RMS) (Forward) indicator lamp* → P. 6-42, 6-49, 6-51 | 10- High coolant temperature warning lamp (red) → P.5-15 | 19- Seat belt warning lamp → P.4-7 |
| 5- Front fog lamp indicator lamp* → P.5-12 | 11- Low coolant temperature indicator lamp (green) → P.5-12 | 20- Forward Collision Mitigation System (Low speed range) (FCM-LS) and Radar sensing misacceleration Mitigation System (RMS) (Forward) OFF indicator lamp* → P. 6-48, 6-49 |
| 6- Auto Stop & Go (AS&G) OFF indicator lamp → P.6-20 | 12- Check engine warning lamp → P. 5-14 | 21- Cruise control indicator lamp* → P.6-39 |
| | 13- Oil pressure warning lamp → P. 5-15 | |
| | 14- Charge warning lamp → P. 5-14 | |
| | 15- Brake warning lamp → P.5-13 | |

Indicator lamps

- 22- Active Stability Control (ASC) indicator lamp → P.6-37
- 23- Active Stability Control (ASC) OFF indicator lamp → P.6-37
- 24- Position lamp indicator lamp → P. 5-12
- 25- Auto Stop & Go (AS&G) indicator → P.6-20
- 26- ECO indicator lamp → P.5-13

5

Indicator lamps

E00501600139

Turn-signal indicator lamps/Hazard warning indicator lamps

E00501701573

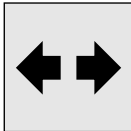

These indicator lamps blink in the following situations.

- When the turn-signal lever is moved to activate a turn-signal lamp.

Refer to “Turn-signal lever” on page 5-19.

- When the hazard warning flasher switch is pressed to activate the hazard warning lamps.

Refer to “Hazard warning flasher switch” on page 5-20.

- When the hazard warning lamps automatically activate due to sudden braking while driving.
Refer to “Emergency stop signal system” on page 6-33.

High-beam indicator lamp

E00501800186

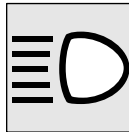

This indicator lamp illuminates when the high beam is used.

Front fog lamp indicator lamp*

E00501900480

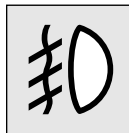

This indicator lamp illuminates while the front fog lamps are on.

Position lamp indicator lamp

E00508901284

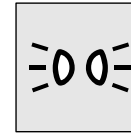

This indicator lamp illuminates while the position lamps are on.

Low coolant temperature indicator lamp

E00502200044

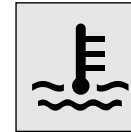

This indicator lamp illuminates in green when the coolant temperature is low.

NOTE

- When the indicator lamp goes out, this should be used as a rough indication of when the heating starts working.

ECO indicator lamp

E00529801143



This indicator lamp illuminates when fuel-efficient driving is achieved.

Warning lamps

E00502400176

Brake warning lamp

E00502503820



This lamp illuminates when the ignition switch is turned to the "ON" position or the operation mode is put in ON, and goes off after a few seconds.

Always make sure that the lamp goes off before driving.

With the ignition switch or the operation mode in ON, the brake warning lamp illuminates under the following conditions:

- When the parking brake has been applied.
- When the brake fluid level in the reservoir falls to a low level.
- When the brake force distribution function is not operating correctly.

With the ignition switch or the operation mode in ON, a buzzer sounds under the following condition:

- The vehicle speed exceeds 8 km/h with the parking brake applied.

CAUTION

• In the situations listed below, brake performance may be compromised or the vehicle may become unstable if brakes are applied suddenly; consequently, avoid driving at high speeds or applying the brakes suddenly. Furthermore, immediately the vehicle should be brought to a stop in a safe location and your nearest authorised MITSUBISHI MOTORS dealer should be contacted.

- The brake warning lamp does not illuminate when the parking brake is applied or does not turn off when the parking brake is released.
- The ABS warning lamp and brake warning lamp illuminate at the same time. For details, refer to "ABS warning lamp" on page 6-34.
- The brake warning lamp remains illuminated during driving.
- The vehicle should be brought to a halt in the following manner when brake performance has deteriorated.
 - Depress the brake pedal harder than usual. Even if the brake pedal moves down to the very end of its possible stroke, keep it pressed down hard.

CAUTION

- Should the brakes fail, use engine braking to reduce your speed and carefully pull the parking brake lever. Depress the brake pedal to operate the stop lamp to alert the vehicles behind you.

Warning lamps

Check engine warning lamp

E00502603300

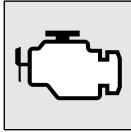

5

This lamp is a part of an onboard diagnostic system which monitors the emissions, engine control system or CVT control system.

If a problem is detected in one of these systems, this lamp illuminates or flashes.

Although your vehicle will usually be drivable and not need towing, we recommend you to have the system checked immediately.

This lamp will also illuminate when the ignition switch is turned "ON" or the operation mode is put in ON, and goes off after the engine has started. If it does not go off after the engine has started, take the vehicle to an authorised MITSUBISHI MOTORS dealer.

CAUTION

- Prolonged driving with this lamp on may cause further damage to the emission control system. It could also affect fuel economy and drivability.
- If the lamp does not illuminate when the ignition switch is turned to the "ON" position or the operation mode is put in ON, have the system checked at an authorised MITSUBISHI MOTORS dealer.
- If the lamp illuminates while the engine is running, avoid driving at high speeds and have the system checked at an authorised MITSUBISHI MOTORS dealer immediately.
Accelerator pedal and brake pedal response may be negatively influenced under these conditions.

NOTE

- The engine electronic control module accommodating the onboard diagnostic system has various fault data (especially about the exhaust emission) stored.
This data will be erased if a battery cable is disconnected which will make a rapid diagnosis difficult. Do not disconnect a battery cable when the check engine warning lamp is ON.

Charge warning lamp

E00502701235

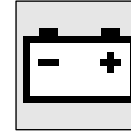

This lamp illuminates when the ignition switch is turned to the "ON" position or the operation mode is put in ON, and goes off after the engine has started.

CAUTION

- If it illuminates while the engine is running, there is a problem in the charging system. Immediately park your vehicle in a safe place and contact your nearest authorised MITSUBISHI MOTORS dealer.

Oil pressure warning lamp

E00502800691

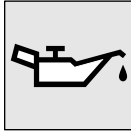

This lamp illuminates when the ignition switch is turned to the "ON" position or the operation mode is put in ON, and the lamp goes off after the engine has started. If it illuminates while the engine is running, the oil pressure is too low.

If the warning lamp illuminates while the engine is running, turn the engine off and contact your nearest authorised MITSUBISHI MOTORS dealer for inspection.

CAUTION

- If this lamp illuminates when the engine oil level is not low, contact your nearest authorised MITSUBISHI MOTORS dealer for inspection.
- This warning lamp does not indicate the amount of oil in the crankcase. This must be determined by checking the oil level on the dipstick, while the engine is switched off.
- If you continue driving with low engine oil level or with this warning lamp illuminated, engine seizure may occur.

NOTE

- The oil pressure warning lamp should not be treated as an indication of the engine's oil level. The oil level must be checked using the dipstick.

High coolant temperature warning lamp

E00503000049

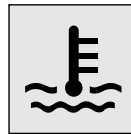

This lamp illuminates in red if the coolant temperature becomes excessively high.

CAUTION

- If the lamp illuminates during vehicle operation, it indicates that the engine is possibly overheating. Continued driving could make the engine fail. Immediately stop the vehicle in a safe place and take appropriate action. (Refer to "Engine overheating" on page 8-4.)

NOTE

- The high coolant temperature warning lamp may illuminate when the vehicle has been driven at high speeds or on hilly roads. This illuminating does not necessarily indicate a problem. It should stop if you keep the engine running for a while or continue driving the vehicle.

Door-ajar warning lamp

E00503300853



This lamp illuminates when a door or the tailgate is either open or not completely closed.

If the vehicle speed reaches approximately 8 km/h with a door or the tailgate open or incompletely closed, a buzzer sounds 4 times as a warning.

CAUTION

- Before moving your vehicle, check that the warning lamp is OFF.

Combination headlamps and dipper switch

Combination headlamps and dipper switch

E00506005205

Headlamps

5

NOTE

- Do not leave the lamps on for a long time while the engine is stationary (not running). A run-down battery could result.
- When it rains, or when the vehicle has been washed, the inside of the lens sometimes becomes foggy, but this does not indicate a functional problem. When the lamp is switched on, the heat will remove the fog. However, if water gathers inside the lamp, please go to an authorised MITSUBISHI MOTORS dealer for a check.

Type 1

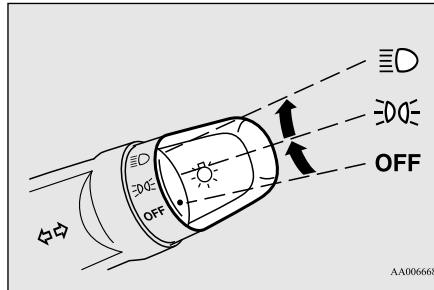

Type 2

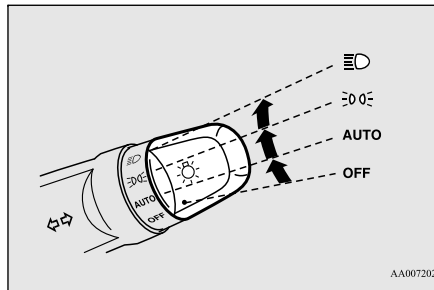

Rotate the switch to turn on the lamps.

OFF	All lamps off {except for daytimerunning lamps (if so equipped)}
-----	--

AUTO	(Type 2 only) With the ignition switch or the operation mode is in ON, headlamps, position, tail, licence plate, and instrument panel lamps turn on and off automatically in accordance with outside light level. {Daytime running lamps (if so equipped) will go on while the tail lamps are off.} All lamps turn off automatically when the ignition switch is turned to "OFF" position or the operation mode is put in OFF.
DIPPER	Position, tail, licence plate and instrument panel lamps on
DIPPER	Headlamps and other lamps go on

NOTE

- The sensitivity of the automatic on/off control can be adjusted.
For further information, please contact your authorised MITSUBISHI MOTORS dealer.
- If the front fog lamps (if so equipped) turn on when they are supposed to with the switch in the "AUTO" position, the lamps turn off automatically with the ignition switch or operation mode off.

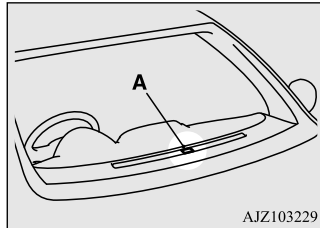

NOTE

- When the headlamps are turned off by the automatic on/off control with the ignition switch is turned to the “ON” position or the operation mode in ON, the front fog lamps (if so equipped) also go off. When the headlamps are subsequently turned back on by the automatic on/off control, the front fog lamps also come on.
- Do not place anything on the automatic light sensor (A), and do not clean with a glasscleaner.



- If the lamps do not turn on or off with the switch in the “AUTO” position, manually operate the switch and have the vehicle inspected at an authorised MITSUBISHI MOTORS dealer.



Lamps (headlamps, fog lamp, etc.) auto-cutout function

- If the following operation is performed while the lamp switch is in the “” position, the lamps will turn off automatically when the driver’s door is opened.
[Except for vehicles equipped with the keyless operation system]
The ignition switch is turned to the “LOCK” or “ACC” position, or the key is removed from the ignition switch.
[For vehicles equipped with the keyless operation system]
The operation mode is put in OFF or ACC.
- If the following operation is performed while the lamp switch is in the “” position, the lamps will remain on for about 3 minutes while the driver’s door is shut and will then automatically turn off.
[Except for vehicles equipped with the keyless operation system]
The ignition switch is turned to the “LOCK” or “ACC” position, or the key is removed from the ignition switch.
[For vehicles equipped with the keyless operation system]
The operation mode is put in OFF or ACC.

NOTE

- The lamp auto-cutout will not function when the lamp switch is in the “” position.
- The lamp auto-cutout function can also be disabled.
For further information, please contact your authorised MITSUBISHI MOTORS dealer.

When you want to keep the lamps on:

1. In the following cases, turn the lamp switch to the “OFF” position.
[Except for vehicles equipped with the keyless operation system]
The ignition switch is in the “LOCK” or “ACC” position.
[For vehicles equipped with the keyless operation system]
The operation mode is in OFF or ACC.
2. Turn on the lamps with the switch in the “” or “” position again, then the lamps will remain on.

Lamp monitor buzzer

E00506101644

If the following operation is performed, a buzzer will sound to remind the driver to turn off the lamps.

Combination headlamps and dipper switch

[Except for vehicles equipped with the keyless operation system]

If the driver's door is opened when the key is in the "LOCK" or "ACC" position or removed from the ignition switch while the lamps are on.

[For vehicles equipped with the keyless operation system]

If the driver's door is opened when the operation mode is in ACC or OFF while the lamps are on.

In both cases, the buzzer will automatically stop if the auto-cutoff function is activated, the lamp switch is turned off, or the door is closed.

Daytime running lamps*

E00530601718

The daytime running lamps come on when the engine is running and the lamp switch is in the "OFF" or "AUTO" position and the tail lamps are off.

Dipper (High/Low beam change)

E00506200521

When the lamp switch is in the "D" position, the beam changes from high to low (or low to high) each time the lever is pulled

fully (1). While the high beam is on, the high beam indicator lamp in the instrument cluster will also illuminate.

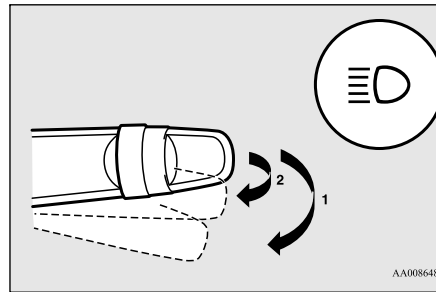

Headlamp flasher

E00506300362

The high beams flash when the lever is pulled slightly (2), and will go off when it is released.

When the high beam is on, the high beam indicator lamp in the instrument cluster will illuminate.

NOTE

- The high beams can also flash when the lamp switch is OFF.

NOTE

- If you turn the lamps off with the headlamps set to high-beam, the headlamps are automatically returned to their low-beam setting when the lamp switch is next turned to the "D" position.

Welcome light

E00528902317

This function turns on the position and tail lamps for about 30 seconds after the UNLOCK switch on the remote control transmitter is pressed when the combination headlamps and dipper switch is in the "OFF" or "AUTO" position (for vehicles equipped with the automatic lamp control). On vehicles equipped with the automatic lamp control, the welcome light function will operate only when it is dark outside the vehicle.

NOTE

- While the welcome light function is operating, perform one of the following operations to cancel the function.
 - Press the LOCK switch on the remote control transmitter.
 - Turn the combination headlamps and dipper switch to the "D" or "D" position.
 - Turn the ignition switch to the "ON" position or put the operation mode in ON.
- It is possible to modify functions as follows:

NOTE

- The headlamps can be set to come on in the low beam setting.
 - The welcome light function can be deactivated.
- For further information, please contact your authorised MITSUBISHI MOTORS dealer.

Coming home light

E00529002009

This function turns on the headlamps in the low beam setting for about 30 seconds after the ignition switch is turned to the “LOCK” position or the operation mode is put in OFF.

1. Turn the combination headlamps and dipper switch to the “OFF” or “AUTO” position (for vehicles equipped with the automatic lamp control).
2. Turn the ignition switch to the “LOCK” position or put the operation mode in OFF. Also, if a key was used to start the engine, remove the key from the ignition switch.
3. Within 60 seconds of turning the ignition switch to the “LOCK” position or putting the operation mode in OFF, pull the turn-signal lever towards you.

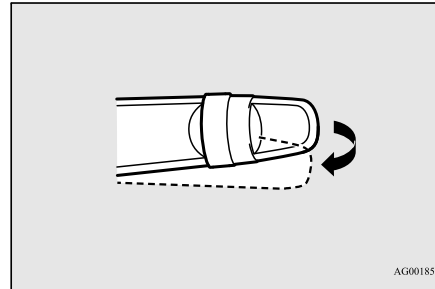

AG0018597

4. The headlamps will come on in the low beam setting for about 30 seconds. After the headlamps go off, the headlamps can be turned on again in the low beam setting for about 30 seconds by pulling the turn-signal lever towards you within 60 seconds of turning the ignition switch to the “LOCK” position or putting the operation mode in OFF.

To turn on the headlamps again after 60 seconds of turning the ignition switch to the “LOCK” position or putting the operation mode in OFF, repeat the process from step 1.

NOTE

- While the coming home light function is operating, perform one of the following operations to cancel the function.
 - Pull the turn-signal lever towards you.

NOTE

- Turn the combination headlamps and dipper switch to the “OFF” or “AUTO” position.
 - Turn the ignition switch to the “ON” position or put the operation mode in ON.
 - It is possible to modify functions as follows:
 - The time that the headlamps remain on can be changed.
 - The coming home light function can be deactivated.
- For further information, please contact your authorised MITSUBISHI MOTORS dealer.

5**Turn-signal lever**

E00506502674

The turn-signal lamps flash when the lever is operated (with the ignition switch or the operation mode is in ON). At the same time, the turn-signal indicator flashes.

Hazard warning flasher switch

5

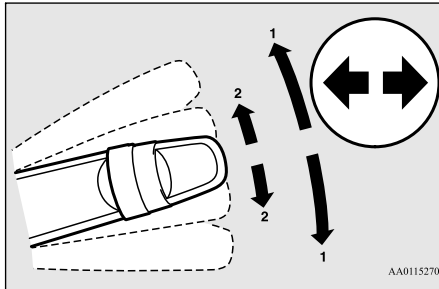

1- Turn-signals

When making a normal turn, use position (1). The lever will return automatically when cornering is completed.

2- Lane-change signals

When moving the lever to (2) slightly to change a lane, the turn-signal lamps and indicator lamp in the instrument cluster will only flash while the lever is operated.

Also, when you move the lever to (2) slightly then release it, the turn-signal lamps and indicator lamp in the instrument cluster will flash 3 times.

NOTE

- If the lamp flashes unusually quickly, the bulb in a turn-signal lamp may have burned out. Have the vehicle inspected by an authorised MITSUBISHI MOTORS dealer.

NOTE

- It is possible to activate the following functions. For further information, please contact your authorised MITSUBISHI MOTORS dealer.
- Flashing of the turn-signal lamps when the lever is operated with the ignition switch or the operation mode is in ACC.
- The turn-signal lamps 3-flash function for lane changes can be deactivated.
- The time required to operate the lever for the 3-flash function can be adjusted.
- Changing of the tone of a sounding buzzer as the turn-signal lamps flash.

Hazard warning flasher switch

E00506602268

Use the hazard warning flasher switch when the vehicle has to be parked on the road for any emergency.

The hazard warning flashers can always be operated, regardless of the ignition switch position or the operation mode.

Push the switch to turn on the hazard warning flashers, all turn-signal lamps flash continuously.

To turn them off, push the switch again.

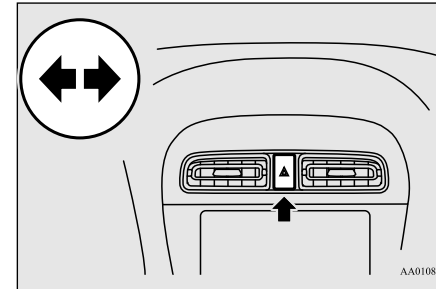

NOTE

- While the hazard warning lamps are blinking due to having manually pushed the switch, the emergency stop signal system does not operate. Refer to "Emergency stop signal system" on page 6-33.

Front fog lamp switch*

E00506701350

The front fog lamps can be operated while the headlamps or tail lamps are on. Turn the knob in the "ON" direction to turn on the front fog lamps. An indicator lamp in the instrument cluster will also come on. Turn the knob in the "OFF" direction to turn off the front fog lamps. The knob will automatically return to its original position when you release it.

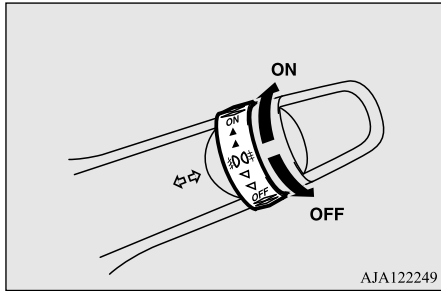

AJA122249

CAUTION

- If the washer is used in cold weather, the washer fluid sprayed against the glass may freeze, which may hinder visibility. Warm the glass with the defroster or rear window demister before using the washer.

Windscreen wipers

E00516902062

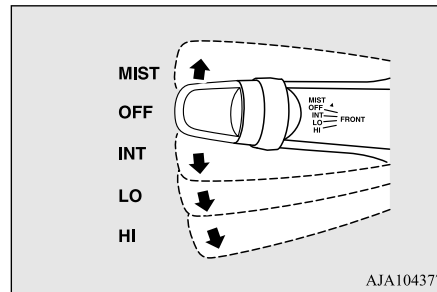

AJA104377

MIST- Misting function

The wipers will operate once.

OFF- Off

INT- Intermittent (Speed sensitive)

LO- Slow

HI- Fast

To adjust intermittent intervals

With the lever in the “INT” (speed sensitive intermittent operation) position, the intermittent intervals can be adjusted by turning the knob (A).

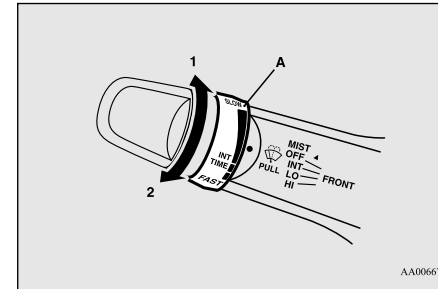

AA0066763

- 1- Fast
- 2- Slow

5

NOTE

- The front fog lamps are automatically turned off when the headlamps or tail lamps are turned off. To turn the front fog lamps on again, turn the knob in the “ON” direction after turning on the headlamps or tail lamps.
- Do not use fog lamps except in conditions of fog, otherwise excessive lamp glare may temporarily blind oncoming vehicle drivers.

Wiper and washer switch

E00507101696

The windscreen wipers, rear window wiper and washer can be operated with the ignition switch or the operation mode in ON or ACC. If the blades are frozen to the windscreen or rear window, do not operate the wipers until the ice has melted and the blades are freed, otherwise the wiper motor may be damaged.

NOTE

- The speed-sensitive-operation function of the windscreen wipers can be deactivated. For further information, please contact your authorised MITSUBISHI MOTORS dealer.

Wiper and washer switch

Misting function

Move the lever in the direction of the arrow and release, to operate the wipers once. Use this function when you are driving in mist or drizzle.

5

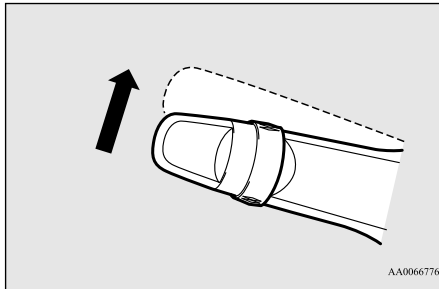

Windscreen washer

E00507201189

The washer fluid will be sprayed onto the windscreen by pulling the lever towards you. The wipers operate automatically several times while the washer fluid is being sprayed.

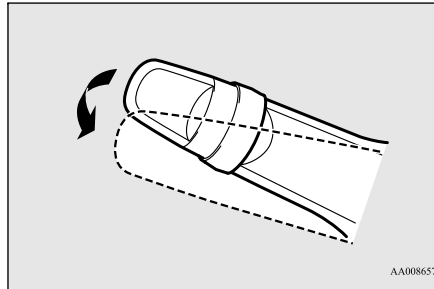

CAUTION

- If the washer is used in cold weather, the washer fluid sprayed against the glass may freeze resulting in poor visibility. Heat the glass with the defroster or demister before using the washer.

Rear window wiper and washer

E00507302578

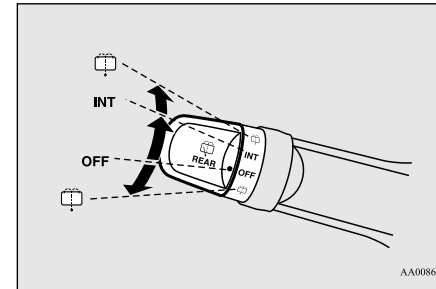

INT - The wiper operates continuously for several seconds then operates intermittently at intervals of about every 8 seconds.

OFF - Off

 - The washer fluid will be sprayed onto the rear window when the knob is turned fully in either direction. The wipers operate automatically several times while the washer fluid is being sprayed.

NOTE

- On vehicles with CVT, to ensure a clear rearward view, the wiper perform several continuous operations when the reverse gear is engaged and the switch is in the “INT” position. Following this continuous operation, the wiper will automatically switch to intermittent operation.
- It is possible to activate the following functions. For further information, please contact your authorised MITSUBISHI MOTORS dealer.
 - Adjustment of the interval for intermittent operation.
 - Changing intermittent wiper operation to continuous wiper operation.

Precautions to observe when using wipers and washers

E00507601428

- If the moving wipers become blocked partway through a sweep by ice or other deposits on the glass, the wipers may temporarily stop operating to prevent the motor from overheating. In this case, park the vehicle in a safe place, turn the ignition switch to the “LOCK” position or put the operation mode in OFF, and then remove the ice or other deposits.

Because the wipers will start operating again after the wiper motor cools down, check that the wipers operate before using them.

- Do not use the wipers when the glass is dry. They may scratch the glass surface and the blades wear out prematurely.
- Before using the wipers in cold weather, check that the wiper blades are not frozen onto the glass. The motor may burn out if the wipers are used with the blades frozen onto the glass.
- Avoid using the washer continuously for more than 20 seconds. Do not operate the washer when the fluid reservoir is empty. Otherwise, the motor may burn out.
- Periodically check the level of washer fluid in the reservoir and refill if required. During cold weather, add a recommended washer solution that will not freeze in the washer reservoir. Failure to do so could result in loss of washer function and frost damage to the system components.

Rear window demister switch

E00507902561

The rear window demister switch can be operated when the engine is running.

Rear window demister switch

Push the switch to turn on the rear window demister. It will be turned off automatically in about 20 minutes. To turn off the demister within about 20 minutes, push the switch again.

The indicator lamp (A) will illuminate while the demister is on.

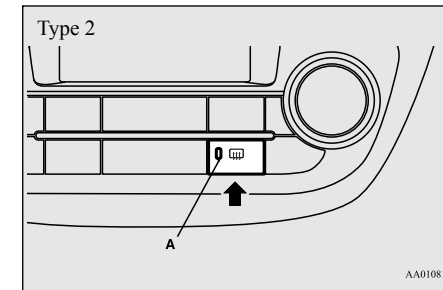
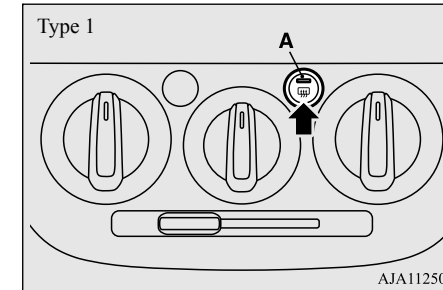

5

Horn switch

5

NOTE

- The demister switch is not to melt snow but to clear mist. Remove snow before use of the demister switch.
- To avoid unnecessary discharge of the battery, do not use the rear window demister during starting of the engine or when the engine is not running. Turn the demister off immediately after the window is clear.
- When cleaning the inside of the rear window, use a soft cloth and wipe gently along the heater wires, being careful not to damage the wires.
- Do not allow objects to touch the inside of the rear window glass, damaged or broken wires may result.

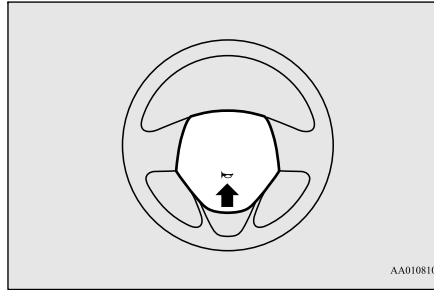

Horn switch

E0050800640

Press the steering wheel on or around the “H” mark.

Starting and driving

Economical driving	6-2	Radar sensing misacceleration Mitigation System	
Driving, alcohol and drugs	6-3	(RMS) (Forward)*	6-51
Safe driving techniques	6-3	Rear-view camera*	6-54
Running-in recommendations	6-4	Cargo loads	6-57
Parking brake	6-4		
Parking	6-5		
Steering wheel height adjustment	6-6		
Inside rear-view mirror	6-7		
Outside rear-view mirrors	6-8		
Ignition switch*	6-11		
Engine switch*	6-12		
Steering wheel lock	6-14		
Starting	6-16		
Auto Stop & Go (AS&G) system	6-20		
Manual transmission*	6-24		
Automatic transmission INVECS-III CVT (Intelligent & Innovative Vehicle Electronic Control System III)*	6-25		
Braking	6-30		
Hill start assist	6-31		
Brake assist system	6-32		
Emergency stop signal system	6-33		
Anti-lock brake system (ABS)	6-33		
Electric power steering system (EPS)	6-35		
Active stability control (ASC)	6-36		
Cruise control*	6-38		
Forward Collision Mitigation System (Low speed range) (FCM-LS)*	6-42		

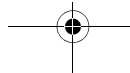

Economical driving

E00600102754

For economical driving, there are some technical requirements that have to be met. The prerequisite for low fuel consumption is a properly adjusted engine. In order to achieve longer life of the vehicle and the most economical operation, have the vehicle serviced by an authorised MITSUBISHI MOTORS dealer at regular intervals in accordance with the service standards.

Fuel economy and generation of exhaust gas and noise are highly influenced by personal driving habits as well as the particular operating conditions. The following points should be observed in order to minimize wear of brakes, tyres and engine as well as to reduce environmental pollution.

Accelerating and decelerating

Drive according to traffic conditions, and avoid sudden starts, sudden acceleration, and sudden braking, as they will increase fuel consumption.

Shifting

Shift only at an appropriate speed and engine speed. Always use the highest shift position possible.

City traffic

Frequent starting and stopping increases the average fuel consumption. Use roads with smooth traffic flow whenever possible. When driving on congested roads, avoid use of a low shift position at high engine speeds.

Idling

The vehicle consumes fuel even during idling. Avoid extended idling whenever possible.

Speed

At higher the vehicle speed, more fuel is consumed. Avoid driving at full speed. Even a slight release of the accelerator pedal will save a significant amount of fuel.

Tyre inflation pressure

Check the tyre inflation pressures at regular intervals. Low tyre inflation pressure increases road resistance and fuel consumption. In addition, low tyre pressures adversely affect tyre wear and driving stability.

Load

Do not drive with unnecessary articles in the luggage compartment. Especially during city driving where frequent starting and stopping is necessary, the increased weight of the vehicle will greatly affect fuel consumption. Also avoid driving with unnecessary luggage, etc., on the roof; the increased air resistance will increase fuel consumption.

Cold engine starting

Starting of a cold engine consumes more fuel. Unnecessary fuel consumption is also caused by keeping a hot engine running. After the engine is started, commence driving as soon as possible.

Cooler or air conditioning

The use of the cooler or air conditioning will increase the fuel consumption.

Driving, alcohol and drugs

E00600200096

Drunk driving is one of the most frequent causes of accidents.

Your driving ability can be seriously impaired even with blood alcohol levels far below the legal minimum. If you have been drinking, don't drive. Ride with a designated non-drinking driver, call a cab or a friend, or use public transportation. Drinking coffee or taking a cold shower will not make you sober.

Similarly, prescription and nonprescription drugs affect your alertness, perception and reaction time. Consult with your doctor or pharmacist before driving while under the influence of any of these medications.

⚠ WARNING

- **NEVER DRINK AND DRIVE.**
Your perceptions are less accurate, your reflexes are slower and your judgment is impaired.

Safe driving techniques

E00600300619

Driving safety and protection against injury cannot be fully ensured. However, we recommend that you pay extra attention to the following:

Seat belts

Before starting the vehicle, make sure that you and your passengers have fastened your seat belts.

Floor mats

⚠ WARNING

- **Keep floor mats clear of the pedals by correctly laying floor mats that are suitable for the vehicle.**
To prevent the floor mats from slipping out position, securely retain them using the hook etc.
Note that laying a floor mat over a pedal or laying one floor mat on top of another can obstruct pedal operation and lead to a serious accident.

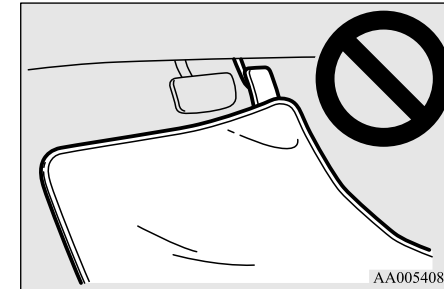

6

Carrying children in the vehicle

- Never leave your vehicle unattended with the key and children inside the vehicle. Children may play with the driving controls and this could lead to an accident.
- Make sure that infants and small children are properly restrained in accordance with the laws and regulations, and for maximum protection in case of an accident.
- Prevent children from playing in the luggage compartment. It is quite dangerous to allow them to play there while the vehicle is moving.

Loading luggage

When loading luggage, be careful not to load above the height of seats. This is dangerous

Running-in recommendations

not only because rearward vision will be obstructed, but also the luggage may be projected into the passenger compartment under hard braking.

Running-in recommendations

E00600404735

6

During the running-in period for the first 1,000 km, it is advisable to drive your new vehicle using the following precautions as a guideline to aid long life as well as future economy and performance.

- Do not race the engine at high speeds.
- Avoid rapid starting, accelerating, braking and prolonged high-speed running.
- Keep to the running-in speed limit shown below.

Please note that the legal speed limits displayed must be adhered to.

- Do not exceed loading limits.
- Refrain from towing a trailer.

Vehicles with M/T

Shift point	Speed limit
1st gear	30 km/h
2nd gear	55 km/h

Shift point	Speed limit
3rd gear	80 km/h
4th gear	110 km/h
5th gear	110 km/h

Vehicles with CVT

Shift point	Speed limit
“D” (DRIVE)	100 km/h

Parking brake

E00600501719

To park the vehicle, first bring it to a complete stop, fully apply the parking brake sufficiently to hold the vehicle.

To apply

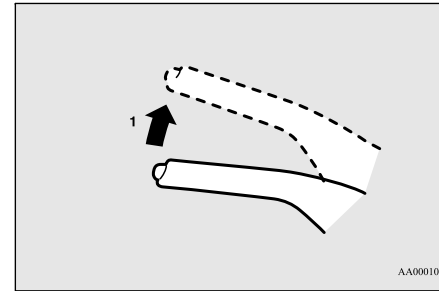

- 1- Firmly depress and hold the brake pedal, then pull the lever up without pushing the button at the end of hand grip.

CAUTION

- When you intend to apply the parking brake, firmly press the brake pedal to bring the vehicle to a complete stop before pulling the parking brake lever. Pulling the parking brake lever with the vehicle moving could make the rear wheels lock up, thereby making the vehicle unstable. It could also make the parking brake malfunction.

NOTE

- Apply sufficient force to the parking brake lever to hold the vehicle stationary after the foot brake is released.

NOTE

- If the parking brake does not hold the vehicle stationary after the foot brake is released, contact your authorised MITSUBISHI MOTORS dealer.

To release

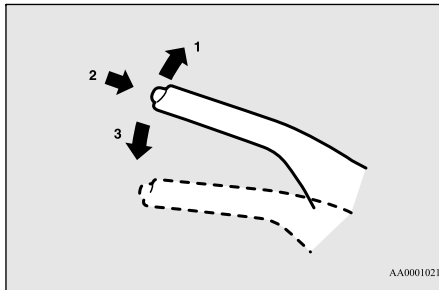

- 1- Firmly depress and hold the brake pedal, then pull the lever up slightly.
- 2- Push the button at the end of hand grip.
- 3- Lower the lever fully.

CAUTION

- Before driving, be sure that the parking brake is fully released and brake warning lamp is off. If you drive without the parking brake fully released, the warning lamp will illuminate and a buzzer sounds when the vehicle speed exceeds 8 km/h. If a vehicle is driven without releasing the parking brake, the brake will be overheated, resulting in ineffective braking and possible brake failure.
- If the brake warning lamp does not extinguish when the parking brake is fully released, the brake system may be abnormal. Contact your authorised MITSUBISHI MOTORS dealer. For details, refer to “Brake warning lamp” on page 5-13.

Parking

E00600601589

To park the vehicle, fully engage the parking brake, and then move the gearshift lever to 1st or “R” (Reverse) position for vehicles with M/T, or set the selector lever to “P” (PARK) position for vehicles with CVT.

Parking on a hill

To prevent the vehicle from rolling into the street, follow these procedures:

Parking on a downhill slope

Turn the front wheels toward the kerb and move the vehicle forward until the kerb side wheel gently touches the kerb.

Apply the parking brake and place the gearshift lever into the “R” (Reverse) position (M/T) or the selector lever into the “P” (PARK) position (CVT).

If necessary, apply chocks to wheels.

Parking on an uphill slope

Turn the front wheels away from the kerb and move the vehicle back until the kerb side wheel gently touches the kerb.

Apply the parking brake and place the gearshift lever into the 1st position (M/T) or the selector lever into the “P” (PARK) position (CVT).

If necessary, apply chocks to wheels.

Steering wheel height adjustment

6

NOTE

- If your vehicle is equipped with CVT, be sure to apply the parking brake before moving the selector lever to the “P” (PARK) position. If you move the selector lever to the “P” (PARK) position before applying the parking brake, it may be difficult to disengage the selector lever from the “P” (PARK) position when next you drive the vehicle, requiring application of a strong force to the selector lever to move from the “P” (PARK) position.

Parking with the engine running

Never leave the engine running while you take a short sleep/rest. Also, never leave the engine running in a closed or poorly ventilated place.

WARNING

- Leaving the engine running risks injury or death from accidentally moving the gear-shift lever (M/T) or the selector lever (CVT) or the accumulation of toxic exhaust fumes on the passenger compartment.

Where you park

WARNING

- Do not park your vehicle in areas where combustible materials such as dry grass or leaves can come in contact with a hot exhaust, since a fire could occur.

Do not keep the steering wheel fully turned for a long time

More effort could be required to turn the steering wheel.

Refer to “Electric power steering system (EPS)” on page 6-35.

When leaving the vehicle

Always carry the key and lock all doors and the tailgate when leaving the vehicle unattended.

Always try to park your vehicle in a well lit area.

Steering wheel height adjustment

E00600700554

1. Release the lever while holding the steering wheel up.
2. Adjust the steering wheel to the desired position.
3. Securely lock the steering wheel by pulling the lever fully upward.

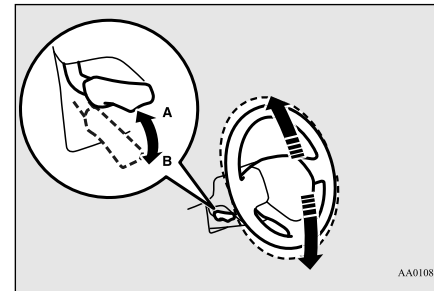

A- Locked

B- Release

WARNING

- Do not attempt to adjust the steering wheel while you are driving the vehicle.

CAUTION

- When releasing the lever, hold the steering wheel by hand to prevent it falling to the lowest position.

Inside rear-view mirror

E00600802285

Adjust the rear-view mirror only after making any seat adjustments so you have a clear view to the rear of the vehicle.

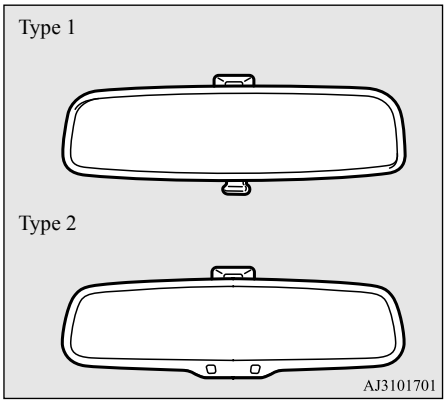

WARNING

- Do not attempt to adjust the rear-view mirror while driving. This can be dangerous. Always adjust the mirror before driving.

Adjust the rear-view mirror to maximize the view through the rear window.

To adjust the vertical mirror position

It is possible to move the mirror up and down to adjust its position.

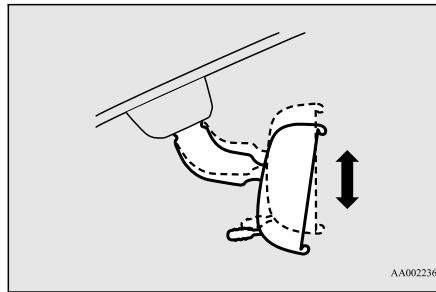

To adjust the mirror position

It is possible to move the mirror up/down and left/right to adjust its position.

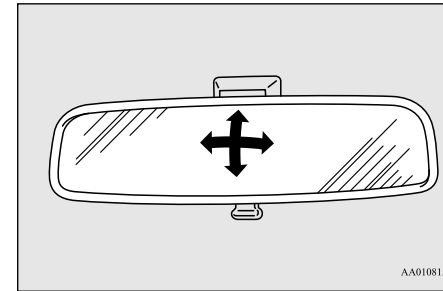

6

Outside rear-view mirrors

To reduce the glare

Type 1

The lever (A) at the bottom of the mirror can be used to adjust the mirror to reduce the glare from the headlamps of vehicles behind you during night driving.

6

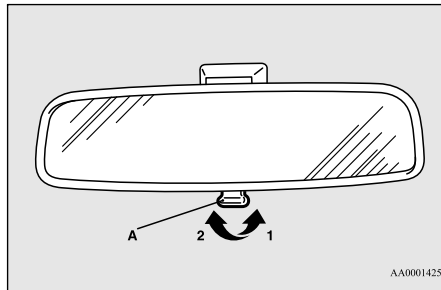

- 1- Normal
- 2- Anti-glare

Type 2

When the headlamps of the vehicles behind you are very bright, the reflection factor of the rear-view mirror is automatically changed to reduce the glare.

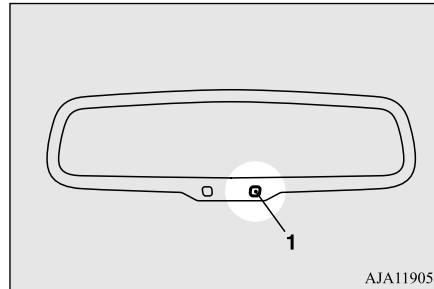

When the ignition switch is turned to the "ON" position or the operation mode is put in ON, the reflection factor of the mirror is automatically changed.

NOTE

- Do not hang items on, or spray glass cleaner on the sensor (1), as reduced sensitivity could result.

Outside rear-view mirrors

E00600901885

To adjust the mirror position

The outside rear-view mirrors can be adjusted when the ignition switch or the operation mode is in ON or ACC.

WARNING

- Do not attempt to adjust the rear-view mirrors while driving. This can be dangerous. Always adjust the mirrors before driving.
- Your vehicle is equipped with convex type mirrors. Please take into consideration. Objects you see in the mirror will look smaller and farther away compared to a normal flat mirror. Do not use this mirror to estimate distance of following vehicles when changing lanes.

1. Place the lever (A) to the same side as the mirror whose adjustment is desired.

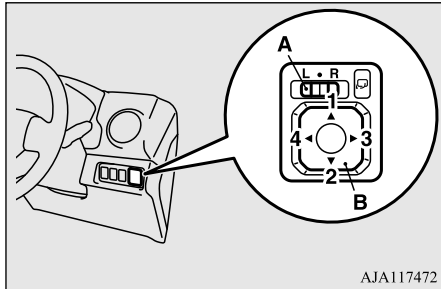

L- Left outside mirror adjustment
R- Right outside mirror adjustment

2. Press the switch (B) to the left, right, up or down to adjust the mirror position.

- 1-Up
- 2-Down
- 3-Right
- 4-Left

3. Return the lever (A) back to the middle position (•).

Retracting and extending the outside mirrors

E00618201803

The outside mirror can be folded in towards the side window to prevent damage when parking in narrow areas.

CAUTION

- Do not drive the vehicle with the mirror folded in. The lack of rearward visibility normally provided the mirror could lead to an accident.

Retracting and extending the mirrors using the mirror retractor switch

With the ignition switch or the operation mode in ON or ACC, push the mirror retractor switch to retract the mirrors.

Push it again to extend the mirrors to their original positions.

After turning the ignition switch to the "LOCK" position or putting the operation mode in OFF, it is possible to retract and extend the mirrors using the mirror retractor switch for approximately 30 seconds.

6

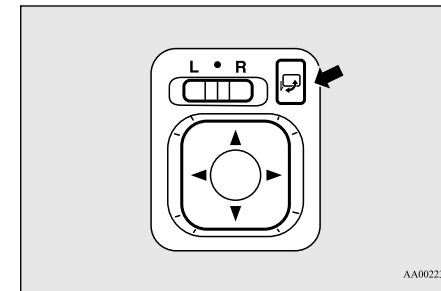

AA0022398

⚠ CAUTION

- It is possible to retract and extend the mirrors by hand. After retracting a mirror using the mirror retractor switch, however, you should extend it by using the switch again, not by hand. If you extended the mirror by hand after retracting it using the switch, it would not properly lock in position. As a result, the mirror could move because of the wind or vibration while you are driving, and this may prevent the driver's rearward visibility.

📖 NOTE

- Be careful not to get your hands trapped while a mirror is moving.
- If you move a mirror by hand or it moves after hitting a person or object, you may not be able to return it to its original position using the mirror retractor switch. If this happens, push the mirror retractor switch to place the mirror in its retracted position and then push the switch again to return the mirror to its original position.
- When freezing has occurred and mirrors fail to operate as intended, please refrain from repeated pushing of the retractor switch as this action can result in burn-out of the mirror motor circuits.

Retracting and extending the mirrors without using the mirror retractor switch

[Except for vehicles equipped with keyless operation system]
The mirrors automatically retract or extend when the doors are locked or unlocked using the remote control switches of the keyless entry system.
Refer to "Keyless entry system" on page 3-4.
[Vehicles with the keyless operation system]
The mirrors automatically retract or extend when the doors are locked or unlocked using the remote control switches or the keyless operation function of the keyless operation system.
Refer to "Keyless entry system" on page 3-4.
Refer to "Keyless operation system: To operate using the keyless operation function" on pages 3-10.

📖 NOTE

- Functions can be modified as stated below. Please consult an authorised MITSUBISHI MOTORS dealer.

📖 NOTE

- Automatically extend when the driver's door is closed, and then the following operation is performed.
[Except for vehicles equipped with the keyless operation system]
Turn the ignition switch to the "ON" or "ACC" position.
[Vehicles equipped with the keyless operation system]
Put the operation mode in ON or ACC.
- Automatically retract when the ignition switch is turned to the "LOCK" position or the operation mode is put in OFF, and the driver's door is then opened.
- Automatically extend when the vehicle speed reaches 30 km/h.
- Deactivate the automatic extension function.
- The outside rear-view mirrors can be folded or extended by the following operations, even if changing to the any of above.
After pressing the "LOCK" switch on the key to lock the doors and tailgate, if the "LOCK" switch is pressed again twice in a row within approximately 30 seconds, the outside rear-view mirrors will retract.
After pressing the "UNLOCK" switch on the key to unlock the doors and tailgate, if the "UNLOCK" switch is pressed again twice in a row within approximately 30 seconds, the outside rear-view mirrors will extend again.

Ignition switch*

E00601403360

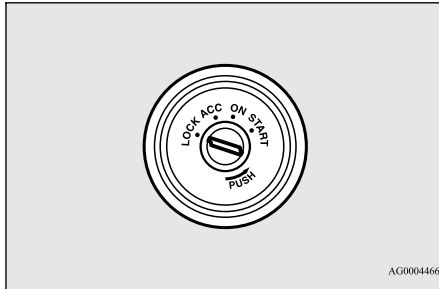

LOCK

The engine is stopped and the steering wheel locked. The key can be inserted and removed in this position.

ACC

The engine is stopped, but the audio system and other electric devices can be operated.

ON

All the vehicle's electrical devices can be operated.

START

The starter motor operates. After the engine has started, release the key and it will automatically return to the "ON" position.

NOTE

- If your vehicle is equipped with an electronic immobilizer. To start the engine, the ID code which the transponder inside the key sends must match the one registered to the immobilizer computer.
(Refer to "Electronic immobilizer (Anti-theft starting system)" on page 3-3.)

To remove the key

E00620400472

For vehicles equipped with a M/T, when removing the key, push the key in at the "ACC" position and keep it depressed until it is turned to the "LOCK" position and remove it.

For vehicles equipped with CVT when removing the key, first set the selector lever to the "P" (PARK) position, and push the key in at the "ACC" position and keep it depressed until it is turned to the "LOCK" position, and remove it.

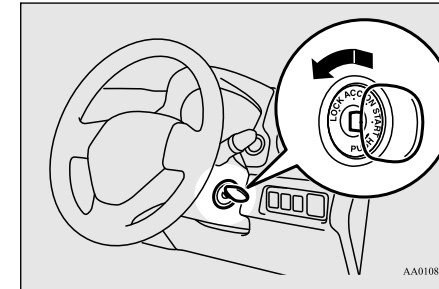

CAUTION

- Do not remove the ignition key from the ignition switch while driving. The steering wheel will be locked, causing loss of control.
- If the engine is stopped while driving, the brake servomechanism will cease to function and braking efficiency will deteriorate. Also, the power steering system will not function and it will require greater manual effort to operate the steering.
- Do not leave the key in the "ON" position for a long time when the engine is not running, doing so will cause the battery to be discharged.
- Do not turn the key to the "START" position when the engine is running, doing so could damage the starter motor.

Engine switch*

Ignition key reminder*

E00654100027

If the ignition switch is turned off and the driver's door is opened with the key in the ignition switch, the key reminder buzzer will sound intermittently to remind you to remove the key.

6

Engine switch*

E00631801561

In order to prevent theft, the engine will not start unless a preregistered keyless operation key is used. (Engine immobilizer function)

If you are carrying the keyless operation key, you can start the engine.

If you have to start the engine in emergency by using spare key, insert the spare key in to the key slot.

Refer to "If the keyless operation key is not operation properly or if the engine starts by using spare key" on page 6-19.

Also refer to "Starting" on page 6-16.

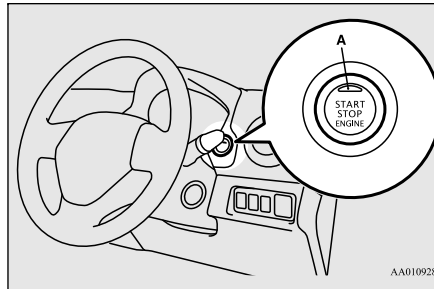

CAUTION

- The indicator lamp (A) will flash orange when there is a problem or malfunction in the keyless operation system. Never drive if the indicator lamp on the engine switch is flashing orange. Immediately contact your authorised MITSUBISHI MOTORS dealer.
- If the engine switch operation is not smooth and feels like it is sticking, do not operate the switch. Immediately contact your authorised MITSUBISHI MOTORS dealer.

NOTE

- When operating the engine switch, press the switch all the way in. If the switch is not fully pressed, the engine may not start or the operation mode may not change. If the engine switch is pressed correctly, there is no need to hold the engine switch down.
- When the battery in the keyless operation key has worn out, or the keyless operation key is out of the vehicle, a warning lamp will blink for 5 seconds.

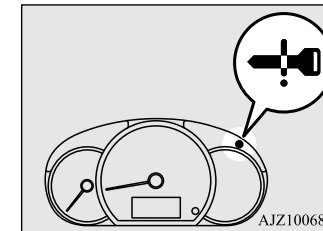

Operation mode of the engine switch and its function

OFF

The indicator lamp on the engine switch goes off.

The operation mode cannot be put in OFF when the selector lever is in any position other than the “P” (PARK) position.

ACC

Electrical devices such as the audio and accessory socket can be operated.

The indicator lamp on the engine switch illuminates orange.

ON

All vehicle’s electrical devices can be operated.

The indicator lamp on the engine switch illuminates green. The indicator lamp goes off when the engine is running.

NOTE

- Your vehicle is equipped with an electronic immobilizer.
To start the engine, the ID code which the transponder inside the key sends must match the one registered in the immobilizer computer. Refer to “Electronic immobilizer (Anti-theft starting system)” on page 3-3.

Changing the operation mode

E00631901490

If you press the engine switch without depressing the brake pedal, you can change the operation mode in the order of OFF, ACC, ON, OFF.

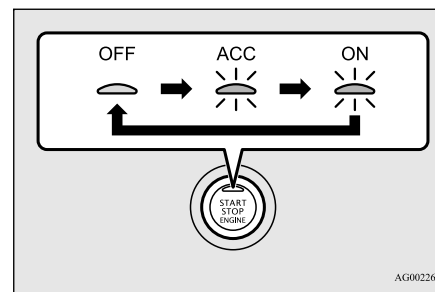

AG0022644

CAUTION

- When the engine is not running, put the operation mode in OFF. Leaving the operation mode in ON or ACC for a long time when the engine is not running may cause the battery to be discharged, making it impossible to start the engine, lock and unlock the steering wheel.
- When the battery is disconnected, the current operation mode is memorized. After reconnecting the battery, the memorized mode is selected automatically. Before disconnecting the battery for repair or replacement, make sure to put the operation mode in OFF. Be careful if you are not sure which operation mode the vehicle is in when the battery is run down.
- The operation mode cannot be changed from OFF to ACC or ON if the keyless operation key is not detected to be in the vehicle. Refer to “Keyless operation system: operating range for starting the engine and changing the operation mode” on page 3-9.
- When there is the keyless operation key in the vehicle and the operation mode isn’t changed, the keyless operation key may have worn out.

6

NOTE

- If the operation mode cannot be changed to OFF, perform the following procedure.

Steering wheel lock

NOTE

1. Move the selector lever to the “P” (PARK) position, and then change the operation mode to OFF (for vehicles with CVT).
2. One of the other causes could be low battery voltage. If this occurs, the keyless entry system, keyless operation function, and steering wheel lock will also not operate. Contact an authorised MITSUBISHI MOTORS dealer.

6

ACC power auto-cutout function

E00632801760

After approximately 30 minutes has elapsed with the operation mode in ACC, the function automatically cuts out the power for the audio system and other electric devices that can be operated with that position. (only that driver's door has closed and the selector lever in the “P” (PARK) position)

When you open driver's door or the engine switch operate again, the power is supplied again.

NOTE

- When ACC power supply automatically stops, the steering wheel can't lock and you can't lock and unlock the doors by the keyless entry system.
- It is possible to modify functions as follows:

NOTE

- The time until the power cuts out can be changed to approximately 60 minutes.
 - The ACC power auto-cutout function can be deactivated.
- For details, please consult an authorised MITSUBISHI MOTORS dealer.

Operation mode OFF reminder system

E00632201403

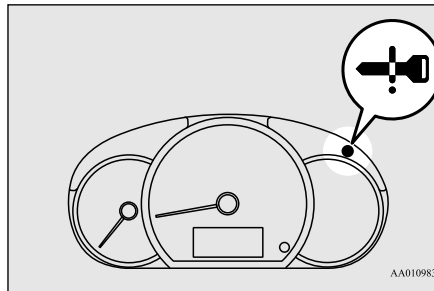

When the operation mode is in any mode other than OFF, if you try to lock the doors and tailgate by pressing the driver's door lock/unlock switch, or the tailgate lock/unlock switch, a warning lamp will blink and the outer buzzer will sound for approximately 3 seconds and you cannot lock the doors and tailgate.

Operation mode ON reminder system

E00632300016

If the driver's door is opened with the engine stopped and the operation mode in any mode other than OFF, the operation mode ON reminder inner buzzer sounds intermittently to remind you to put the operation mode in OFF.

Steering wheel lock

E00601502289

[Except for vehicles equipped with the keyless operation system]

To lock

Remove the key at the “LOCK” position.
Turn the steering wheel until it is locked.

To unlock

Turn the key to the “ACC” position while moving the steering wheel slightly right and left.

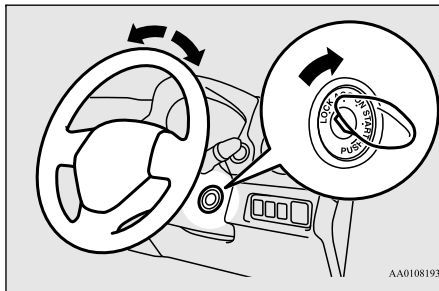
**CAUTION**

- Remove the key when leaving the vehicle. In some countries, it is prohibited to leave the key on the vehicle when parked.

[For vehicles equipped with the keyless operation system]

To lock

After pressing the engine switch and putting the operation mode in OFF, when driver's door is opened, the steering wheel is locked.

NOTE

- When the following operation is performed with the operation mode in OFF and the selector lever is in the “P” (PARK) position, the steering wheel is locked.
 - Open or close the driver's door.
 - Close all the doors and the tailgate.
 - Open one of the doors or the tailgate when all the doors and the tailgate are closed.
 - Lock all the doors and the tailgate with the keyless entry system or the keyless operation function.
- When the driver's door is opened while the steering wheel does not lock, warning indicator will appear and the buzzer sounds to alert the steering wheel is unlocked.

Warning indicator

**To unlock**

The following methods can be used to unlock the steering wheel.

- Put the operation mode in ACC.

- Start the engine.

CAUTION

- If the engine is stopped while driving, do not open a door or press the LOCK switch on the remote control switch until the vehicle stops in a safe place. This could cause the steering wheel to lock, making it impossible to operate the vehicle.
- Carry the key with you when leaving the vehicle. If your vehicle needs to be towed, put the operation mode in ON to unlock the steering wheel.

NOTE

- When the steering wheel does not unlock, the warning lamp will blink and the inner buzzer will sounds. Press the engine switch again while moving the steering wheel slightly right and left.

NOTE

- When the steering wheel lock is abnormal, the warning lamp illuminates. Put the operation mode in OFF and then press the lock switch of the keyless operation key. And then press the engine switch, If the warning lamp illuminates again, contact an authorised MITSUBISHI MOTORS dealer.

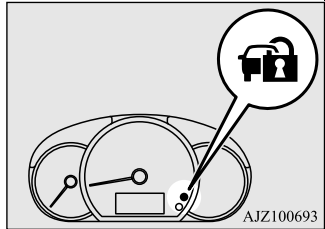

- If there is a fault in the steering wheel lock, the warning lamp illuminates and the inner buzzer sounds. Immediately stop the vehicle in a safe place and contact your nearest authorised MITSUBISHI MOTORS dealer.

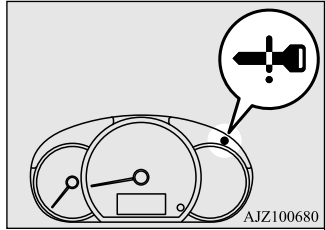

Starting

E00601601052

Tips for starting

E00632400020

[Except for vehicles equipped with the keyless operation system]

Do not operate the starter motor continuously longer than 10 seconds; doing so could run down the battery. If the engine does not start, turn the ignition switch back to “LOCK”, wait a few seconds, and then try again. Trying repeatedly with the starter motor still turning will damage the starter mechanism.

WARNING

- **Never run the engine in a closed or poorly ventilated area any longer than is needed to move your vehicle in or out of the area. Carbon monoxide gases are odourless and can be fatal.**

CAUTION

- Never attempt to start the engine by pushing or pulling the vehicle.
- Do not run the engine at high rpm or drive the vehicle at high speed until the engine has had a chance to warm up.

CAUTION

- Release the ignition key as soon as the engine starts to avoid damaging the starter motor.

[For vehicles equipped with the keyless operation system]

- The operation mode can be in any mode to start the engine.
- The starter motor will be turning for up to approximately 15 seconds if the engine switch is released at once. Pressing the engine switch again while the starter motor is still turning will stop the starter motor. The starter motor will be turning for up to approximately 30 seconds while the engine switch is pressed.

If the engine does not start, wait for a while and then attempt to start the engine again. Trying repeatedly with the starter motor still turning will damage the starter mechanism.

WARNING

- **Never run the engine in a closed or poorly ventilated area any longer than is needed to move your vehicle in or out of the area. Carbon monoxide gases are odourless and can be fatal.**

⚠ CAUTION

- Never attempt to start the engine by pushing or pulling the vehicle.
- Do not run the engine at high rpm or drive the vehicle at high speed until the engine has had a chance to warm up.

Starting the engine

E00601703709

[Except for vehicles equipped with the keyless operation system]

The starting procedure is as follows:

1. Insert the ignition key and fasten the seat belt.
2. Make sure the parking brake is applied.
3. Depress and hold the brake pedal.
4. Fully depress the clutch pedal (M/T).

📖 NOTE

- On vehicles equipped with M/T, the starter will not operate unless the clutch pedal is fully depressed (Clutch interlock).

5. On vehicles with M/T, place the gearshift lever in the “N” (Neutral) position. On vehicles with CVT, make sure the selector lever is in the “P” (PARK) position.

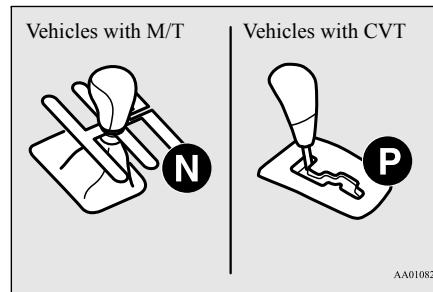

6. After turning the ignition key to the “ON” position, make certain that all warning lamps are functioning properly before starting the engine.
7. Turn the ignition key to the “START” position and release it when the engine starts.

📖 NOTE

- Minor noises may be heard on engine start-up. These will disappear as the engine warms up.

When the engine is hard to start

After several attempts, you may experience that the engine still does not start.

1. Make sure that all electric devices, such as lamps, air conditioning blower and rear window demister, are turned off.
2. While depressing the brake pedal on vehicles equipped with CVT or the clutch pedal on the vehicles equipped with manual transmission, press the accelerator pedal halfway and hold it there, then crank the engine. Release the accelerator pedal, immediately after the engine starts.

6

Starting

6

3. If the engine still will not start, the engine could be flooded with too much petrol. While depressing the brake pedal on vehicles equipped with CVT or the clutch pedal on the vehicles equipped with manual transmission, push the accelerator pedal all the way down and hold it there, then crank the engine for 5 to 6 seconds. Return the ignition switch to the “LOCK” position and release the accelerator pedal. Wait a few seconds, and then crank the engine again for 5 to 6 seconds while depressing the brake pedal or the clutch pedal, but do not push the accelerator pedal. Release the ignition key if the engine starts. If the engine fails to start, repeat these procedures. If the engine still will not start, contact your authorised MITSUBISHI MOTORS dealer.

[For vehicles equipped with the keyless operation system]

The starting procedure is as follows:

1. Fasten the seat belt.
2. Make sure the parking brake is applied.
3. Press and hold the brake pedal down firmly with your right foot.

NOTE

- After the engine has not started for a while, the brake pedal effort needed to start the engine may become greater. If this occurs, depress the brake pedal more firmly than usual.

4. Make sure the selector lever is in the “P” (PARK) position.



5. Press the engine switch.
6. Make certain that all warning lamps are functioning properly.

NOTE

- Minor noises may be heard on engine start-up. These will disappear as the engine warms up.

When the engine is hard to start

After several attempts, you may experience that the engine still does not start.

1. Make sure that all electric devices, such as lamps, air conditioning blower and rear window demister, are turned off.
2. While depressing the brake pedal, press the accelerator pedal halfway and hold it there, then crank the engine. Release the accelerator pedal, immediately after the engine starts.
3. If the engine still will not start, the engine could be flooded with too much petrol. While depressing the brake pedal, push the accelerator pedal all the way down and hold it there, then press the engine switch to crank the engine. If the engine does not start after 5 to 6 seconds, push the engine switch to stop cranking the engine, and release the accelerator pedal. Put the operation mode in OFF. Wait a few seconds, and then press the engine switch to crank the engine again while depressing the brake pedal, but do not push the accelerator pedal. If the engine fails to start, repeat these procedures. If the engine still will not start, contact your authorised MITSUBISHI MOTORS dealer.

Stopping the engine

E00632701091

[For vehicles equipped with the keyless operation system]

WARNING

- Do not operate the engine switch while driving except in an emergency. If the engine is stopped while driving, the brake servomechanism will cease to function and braking efficiency will deteriorate. Also, the power steering system will not function and it will require greater manual effort to operate the steering. This could result in a serious accident.

NOTE

- If you have to bring the engine to an emergency stop while driving, press and hold the engine switch for 3 seconds or more, or press it quickly 3 times or more. The engine will stop and the operation mode will go to ACC.
- Do not stop the engine with the selector lever in any position other than the “P” (PARK) position. If the engine is stopped with the selector lever in any position other than the “P” (PARK) position, the operation mode will go to ACC rather than OFF. Put the operation mode in OFF after placing the selector lever in the “P” (PARK) position.

NOTE

- On vehicles with CVT, while the engine is stopped automatically by Auto Stop & Go (AS&G) system, if the selector lever is moved to the “P” (PARK) position quickly with the brake pedal firmly depressed, the engine does not restart automatically even if you release the brake pedal. If this occurs, the (A) indicator will blink to inform the driver. If you want to put the operation mode in OFF, press the engine switch without depressing the brake pedal.

1. Stop the vehicle.
2. Fully engage the parking brake while depressing the brake pedal.
3. Move the selector lever to the “P” (PARK) position, press the engine switch to stop the engine.

If the keyless operation key is not operating properly or if the engine starts by using spare key

E00632501103

Insert the keyless operation key or spare key into the key slot. Starting the engine and changing the operation mode should be now possible.

Remove the keyless operation key or spare key from the key slot after starting the engine or changing the operation mode.

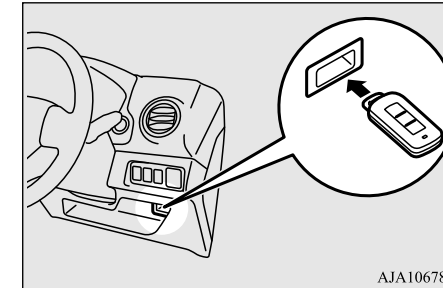

AJA106788

NOTE

- Do not insert into the key slot anything other than the keyless operation key or spare key. This could cause damage or a malfunction.
- Remove the object or additional key from the keyless operation key or spare key before inserting the key into the key slot. The vehicle may not be able to receive the registered ID code from the registered key. Therefore, the engine may not start and the operation mode may not change.
- The keyless operation key is fixed in the key slot when inserted in the illustrated direction. Simply pull out the key to remove it from the key slot.

Auto Stop & Go (AS&G) system

Keyless operation key reminder*

E0063260022

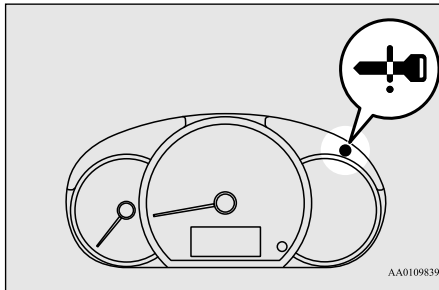

6

If the operation mode is in OFF and the driver's door is opened with the keyless operation key in the key slot, the warning lamp will blink and the outer buzzer sounds for approximately 3 seconds and the inner buzzer sounds for approximately 1 minute to remind you to remove the key.

Auto Stop & Go (AS&G) system

E00627401289

The Auto Stop & Go (AS&G) system automatically stops and restarts the engine without operating the ignition switch or engine switch when the vehicle is stopped, such as at

a traffic light or in a traffic jam, to reduce exhaust gases, increase fuel efficiency.

⚠ CAUTION

- If the vehicle will be stopped for a long time or if you will leave the vehicle unattended, stop the engine.

📖 NOTE

- The accumulated time the engine has been stopped by Auto Stop & Go (AS&G) system is displayed in the multi information display. Refer to "Auto Stop & Go (AS&G) monitor" on page 5-5.
- If the Auto Stop & Go (AS&G) system does not operate or it operates less frequently, the battery capacity may have decreased. Have your vehicle inspected by an authorised MITSUBISHI MOTORS dealer.

Automatically stopping the engine

E00627501596

The Auto Stop & Go (AS&G) system is automatically activated when the ignition switch is turned to the "ON" position or the operation mode is put in ON.

You can deactivate the system by pressing the "Auto Stop & Go (AS&G) OFF" switch. Refer to "To deactivate" on page 6-24.

When the Auto Stop & Go (AS&G) system will operate, the (A) indicator lamp will turn on to inform the driver.

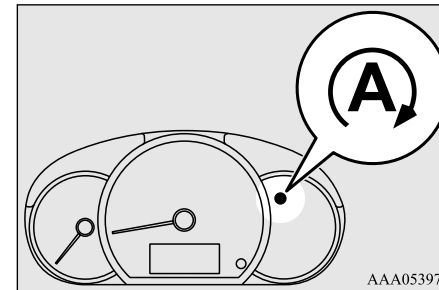

[For vehicles with M/T]

1. Stop the vehicle.
2. While depressing the brake pedal, fully depress the clutch pedal and place the gearshift lever in the "N" (Neutral) position.

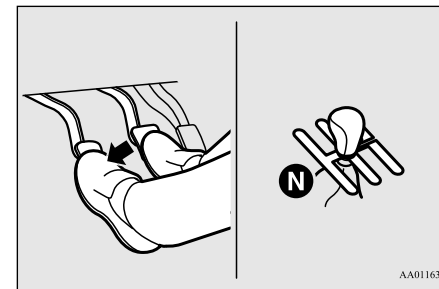

3. Release the clutch pedal. The engine will stop automatically.

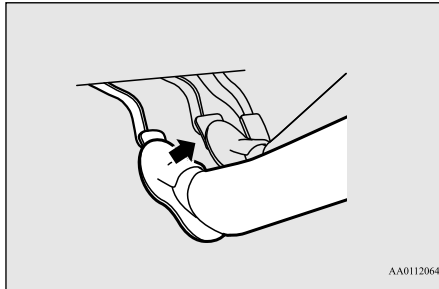

[For vehicles with CVT]

1. Stop the vehicle.
2. Depressing the brake pedal. The engine will stop automatically.

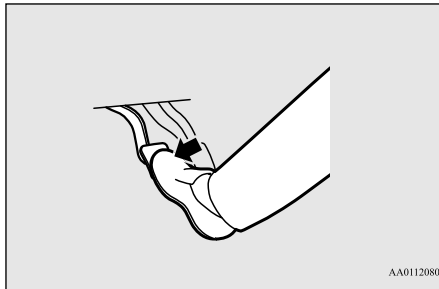

NOTE

- When the engine is automatically stopped, changes will occur in the driving operations. Pay careful attention to the following.
 - The brake booster becomes inoperative and the pedal effort will increase. If the vehicle is moving, press down the brake pedal harder than usual.
 - The electric power steering system (EPS) becomes inoperative and it will become harder to turn the steering wheel.

CAUTION

- When the engine is automatically stopped, do not attempt to exit the vehicle. Because the engine restarts automatically when the driver's seat belt is unfastened or the driver's door is opened, an unexpected accident might occur when the vehicle starts moving.
- Observe the following precautions when the engine is stopped automatically. Otherwise, an unexpected accident might occur when the engine restarts automatically.
 - Do not depress the accelerator pedal to race the engine while the vehicle is stopped (regardless of whether the engine is running or stopped).

CAUTION

- On vehicles with M/T, do not move the gearshift lever to a position other than the "N" (Neutral) position. If the gearshift lever is moved to a position other than the "N" (Neutral) position, the (A) indicator lamp blinks and the buzzer sounds. If the gearshift lever is returned to the "N" (Neutral) position, the (A) indicator lamp stops blinking and the buzzer stops sounding. The engine will not restart if the gearshift lever is in a position other than the "N" (Neutral) position.



NOTE

- In the following cases, the (A) indicator lamp will blink to inform the driver and the engine will not stop automatically.
 - Driver's seat belt is not fastened
 - Driver's door is open
 - Bonnet is open
- In the following cases, the (A) indicator lamp will turn off and the engine will not stop automatically even if the vehicle is stopped.
 - After the engine start, the vehicle speed has not exceeded approximately 5 km/h
 - After the engine start, approximately 30 seconds or more have not elapsed
 - After the engine restarts automatically, the vehicle stops again within 10 seconds

Auto Stop & Go (AS&G) system

6

NOTE

- Engine coolant temperature is low
- Ambient temperature is low
- The cooler or the air conditioner is operating and passenger compartment has not sufficiently cooled
- When using the air conditioner at the demister position
- When the air conditioner is operated in AUTO mode where the temperature control is set to the max. hot or the max. cool (for vehicles with automatic air conditioning)
- Electric power consumption is high, such as when the rear window demister or other electrical components are operating or the blower speed is set to a high setting
- Battery voltage or battery performance is low
- Check engine warning lamp is illuminated or the  indicator lamp is blinking
- The selector lever is other than in the “D” (DRIVE) position (CVT)
- ASC operation indicator and ASC OFF indicator is turn on (CVT)
- ABS warning lamp is turn on
- Selector lever position indicator is blinking (CVT)
- In the following cases, the engine will not stop automatically even if  indicator lamp turn on.
 - Push the accelerator pedal
 - Brake booster vacuum pressure is low

NOTE

- Operate the steering wheel
- Brake pedal is not sufficiently depressed (CVT)
- Parking on steep hill (CVT)
- Parking brake operates (CVT)
- On vehicles with M/T, do not rest your foot on the clutch pedal while driving because this will cause detection of clutch pedal switch malfunction and blinking of the  indicator lamp, and Auto Stop & Go (AS&G) system will not operate.
- If the Auto Stop & Go (AS&G) system operates while the cooler or the air conditioner is operating, both the engine and the air conditioning compressor will stop. Therefore, only the blower will operate, the windows may start to fog up. If this occurs, set the air conditioner to the demister position to restart the engine.
Refer to “Demisting of the windscreen and door windows: For quick demisting” on page 7-11.
- If the windows become fogged up each time the engine is stopped, we recommend you to deactivate the Auto Stop & Go (AS&G) system by pressing the “Auto Stop & Go (AS&G) OFF” switch. Refer to “To deactivate” on page 6-24.
- If the cooler or the air conditioner is operating, set the temperature control higher to lengthen the time that the engine is stopped automatically.

Automatically restarting the engine

E00627601379

On vehicles with M/T, depress the clutch pedal while the gearshift lever is in the “N” (Neutral) position. The  indicator lamp turns off and the engine restarts automatically.

On vehicles with CVT, Release the brake pedal. The  indicator lamp turns off and the engine restart automatically.

NOTE

- On vehicles with M/T, do not move the gearshift lever to a position other than the “N” (Neutral) position or do not release the clutch pedal while the engine is restarting automatically. The starter motor will stop and the engine will not restart automatically.
- If the engine does not restart automatically or if the engine stalls, the charge warning lamp and check engine warning lamp will illuminate.
If this occurs,
[On vehicles with M/T]
The engine will not restart even if the clutch pedal is depressed again. While depressing the brake pedal, fully depress the clutch pedal and turn the ignition switch to the “START” position or press the engine switch to start the engine.

 **NOTE**

[On vehicles with CVT]

The engine will not restart even if release the brake pedal again. Also, the  indicator blinks, and the buzzer sounds.

While depressing the brake pedal, move the selector lever to the “P” (PARK) or “N” (NEUTRAL) position and turn the ignition switch to the “START” position or press the engine switch to start the engine. After the engine is started, the buzzer stops.

But the  indicator is blinking until turning the ignition switch to the “LOCK” position or putting the operation mode in OFF.

For details, refer to “Starting” on page 6-16.

- The vehicles equipped with CVT have the function of preventing the unexpected start of the vehicle due to creeping, etc., by temporarily maintain the braking force applied when the engine restarts automatically. This function is deactivated if the selector lever is set into “N” (NEUTRAL) position. While the function is activated, you might hear operation noise from under the vehicle or feel a shock from the brake pedal. This indicates that the function is operating normally. It does not indicate a malfunction.

 **CAUTION**

- In the following cases, the engine will restart automatically even if the engine was stopped by the Auto Stop & Go (AS&G) system. Pay careful attention, otherwise an unexpected accident might occur when the engine restarts.
 - Vehicle speed is 3 km/h or higher when coasting down a slope
 - Brake booster vacuum pressure is low because the brake pedal is depressed repeatedly or depressed harder than usual
 - Engine coolant temperature is low
 - When the cooler is operated by turning the temperature control dial
 - When the air conditioner is operated by pressing the air conditioning switch
 - When the preset temperature of the cooler or the air conditioner is changed significantly
 - When the air conditioner is operated in AUTO mode where the temperature control is set to the max. hot or the max. cool (for vehicles with automatic air conditioning)
 - When the cooler or the air conditioner is ON, the passenger compartment temperature rises and the air conditioning compressor operates to lower the temperature
 - When the air conditioner is changed to the demister position
 - Electric power consumption is high, such as when the rear window demister or other electrical components are operating or the blower speed is set to a high setting

 **CAUTION**

- Push the accelerator pedal (CVT)
- Battery voltage or battery performance is low
- Operate the steering wheel
- After the engine stop, 3 minute elapse (CVT)
- Move the selector lever to the “R” (REVERSE) position (CVT)
- Move the selector lever from the “N” (NEUTRAL) to “D” (DRIVE) position (CVT)
- Driver’s seat belt is unfastened
- Driver’s door is opened

 **NOTE**

- In the following cases, the engine will not restart automatically.
 - Bonnet is opened
 - On vehicles with M/T, while the engine is stopped automatically, “Auto Stop & Go (AS&G) OFF” switch is pressed to deactivate the “Auto Stop & Go (AS&G) OFF” system.
- When the engine restarts automatically, decrease in audio volume may temporarily be experienced. This does not indicate a malfunction.
- While the engine is stopped automatically, the air volume change of the air conditioner may temporarily be experienced. This does not indicate a malfunction.

Manual transmission*

NOTE

- On vehicles with CVT, while the engine is stopped automatically, if the selector lever is moved to the “P” (PARK) position quickly with the brake pedal firmly depressed, the engine does not restart automatically even if you release the brake pedal. If this occurs, the  indicator will blink to inform the driver. If you want to restart the engine, depress the brake pedal again. If you want to put the operation mode in OFF, press the engine switch without depressing the brake pedal. (Vehicles equipped with the keyless operation system)

To deactivate

E00627701295

The Auto Stop & Go (AS&G) system is automatically activated when the ignition switch is turned to the “ON” position or the operation mode put in ON. You can deactivate the system by pressing the “Auto Stop & Go (AS&G) OFF” switch.

When the Auto Stop & Go (AS&G) system is deactivated, the  indicator will be turned on.

To reactivate the Auto Stop & Go (AS&G) system, press the “Auto Stop & Go (AS&G) OFF” switch; the indicator will turn off.

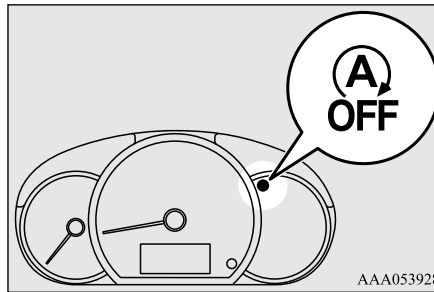
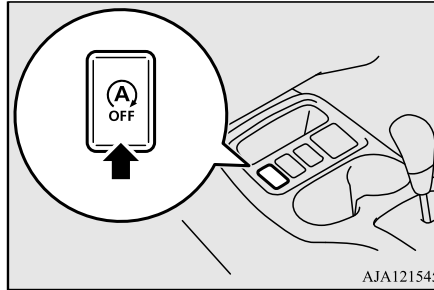

NOTE

- This indicator lamp will also turn on for a few seconds when the ignition switch is turned to the “ON” position or the operation mode put in ON.

If the indicator lamp blinks while driving

E00627801212

If the  indicator lamp blinks, the Auto Stop & Go (AS&G) system is malfunctioning and will not operate.

We recommend you to consult an authorised MITSUBISHI MOTORS dealer.

Manual transmission*

E00602002702

The shift pattern is shown on the gearshift lever knob. Press the clutch pedal all the way down while shifting gears. To start off, press the clutch pedal all the way down and shift into 1st or “R” (Reverse) position, operating the gearshift lever slowly. Then gradually release the clutch pedal while depressing the accelerator pedal.

CAUTION

- Do not put the gearshift lever into the reverse position while the vehicle is moving forward. Doing so could damage the transmission.
- Do not rest your foot on the clutch pedal while driving. Doing so could cause rapid wear to the clutch.
- Do not coast in the “N” (Neutral) position.

Automatic transmission INVECS-III CVT (Intelligent & Innovative Vehicle Electronic Control System III)*

CAUTION

- Do not use the gearshift lever as a handrest, because this can result in premature wear of the transmission shift forks.

NOTE

- During cold weather, shifting may be difficult until the transmission lubricant has warmed up. This is normal and not harmful to the transmission.
- If it is hard to shift into 1st, depress the clutch pedal again; the shift will then be easier to make.
- To shift into the “R” (Reverse) position from 5th gear, move the gearshift lever to the “N” (Neutral) position, and then move it to the “R” (Reverse) position.
- To avoid grinding noises when shifting into reverse, wait approximately 3 seconds with the clutch pedal depressed when the vehicle is stationary.

Changing gears

Always use care to change the gear with the vehicle speed matched to the engine speed. Proper shifting will improve fuel economy and prolong engine life. Avoid shifting down at high speed, as this may cause excessive engine speed and damage the engine.

Possible driving speed

Avoid shifting down at high speed, as this may cause excessive engine speed and damage the engine.

Shift point	Speed limit
1st gear	45 km/h
2nd gear	85 km/h
3rd gear	125 km/h
4th gear	170 km/h

Use 5th gear whenever vehicle speed allows, for maximum fuel economy.

Automatic transmission INVECS-III CVT (Intelligent & Innovative Vehicle Electronic Control System III)*

The CVT will automatically and continuously change its gear ratio depending on road and driving conditions. This helps achieve smooth driving and excellent fuel efficiency.

Selector lever operation

The CVT selects an optimum gear ratio automatically, depending on the speed of the vehicle and the position of the accelerator pedal.

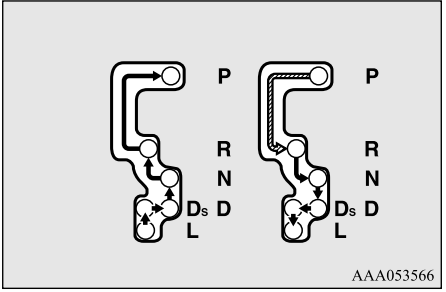
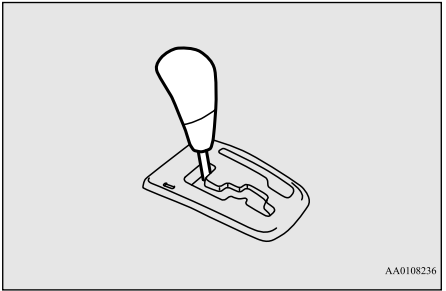

While depressing the brake pedal, move the selector lever through the gate.

6

Automatic transmission INVECS-III CVT (Intelligent & Innovative Vehicle Electronic Control System III)*

↓ Move the selector lever through the gate.

⚠ WARNING

- Always depress the brake pedal when shifting the selector lever into the other position from the “P” (PARK) or “N” (NEUTRAL) position.
- Never put your foot on the accelerator pedal while shifting the selector lever from the “P” (PARK) or “N” (NEUTRAL) position.

6

📖 NOTE

- To avoid erroneous operation, move the selector lever firmly into each position and briefly hold it there. Always check the position shown by the selector lever position display after moving the selector lever.
- If the brake pedal is not depressed and held, the shift-lock device activates to prevent the selector lever from being moved from the “P” (PARK) position.

When the selector lever cannot be shifted from the “P” (PARK) position

E00629000266

When the selector lever cannot be shifted from the “P” (PARK) position to another

position while the brake pedal is pressed and held down with the ignition switch or the operation mode in ON, the battery may be flat or the shift-lock mechanism may be malfunctioning.

Immediately have your vehicle checked by an authorised MITSUBISHI MOTORS dealer. If you need to move the vehicle, shift the selector lever as follows.

1. Make sure the parking brake is fully applied.
2. Stop the engine if it is running.
3. Depress the brake pedal with the right foot.
4. Insert straight blade (or minus) screwdriver in the shift-lock release hole (A). Shift the selector lever to the “N” (NEUTRAL) position while pressing the straight blade (or minus) screwdriver down.

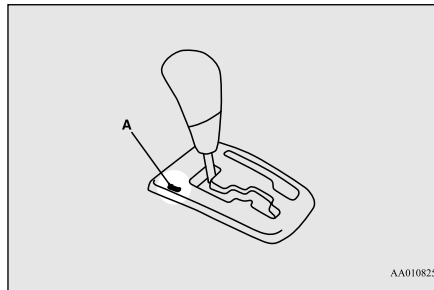

Selector lever position display

E00602300411

When the ignition switch is turned to the “ON” position or the operation mode is put in ON, the position of the selector lever is indicated in the multi-information display.

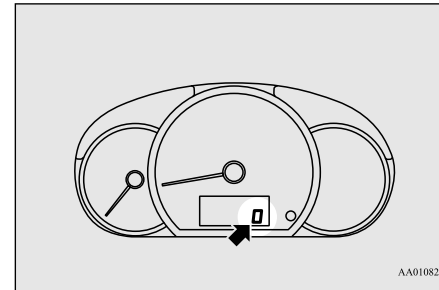

Selector lever positions

E00602401510

“P” PARK

This position locks the transmission to prevent the vehicle from moving. The engine can be started in this position.

“R” REVERSE

This position is to back up.

CAUTION

- Never shift into the “P” (PARK) or “R” (REVERSE) position while the vehicle is in motion to avoid a transmission damage.

“N” NEUTRAL

At this position the transmission is disengaged. It is the same as the neutral position on a manual transmission, and should only be used when the vehicle is stationary for an extended length of time during driving, such as in a traffic jam.

WARNING

- Never move the selector lever to the “N” (NEUTRAL) position while driving. A serious accident could occur since you could accidentally move the lever into the “P” (PARK) or “R” (REVERSE) position or you will lose engine braking.
- On a gradient the engine should be started in the “P” (PARK) position, not in the “N” (NEUTRAL) position.

WARNING

- To prevent rolling, always keep your foot on the brake pedal when the vehicle is in “N” (NEUTRAL) position, or when shifting into or out of “N” (NEUTRAL) position.

“D” DRIVE

This position is used for most city and highway driving. The transmission will automatically and continuously change its gear ratio depending on road and driving conditions.

CAUTION

- To prevent transmission damage, never shift into the “D” (DRIVE) position from the “R” (REVERSE) position while the vehicle is in motion.

“Ds” DOWNSHIFT & SPORTY DRIVING

Use when engine braking is needed, or for high-power sport drive.

“L” LOW

This position is for driving up very steep hills and for engine braking at low speeds when driving down steep hills.

WARNING

- This position can be used for maximum engine braking. Be very careful not to shift into “L” (LOW) suddenly. Sudden engine braking may cause the tyres to skid. Select this position according to the road conditions and vehicle speed.

When a malfunction occurs in the automatic transmission

E0063200013

6

When the selector lever position indicator blinks

E00632101301

When the selector lever position indicator blinks while you are driving, there could be a malfunction in the automatic transmission system or CVT fluid temperature becomes abnormally high.

6

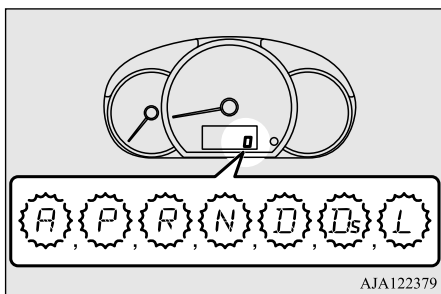

AJA122379

NOTE

- The “A” indicator on the selector lever position display will only blink if there is a problem with the CVT position switch. It is not seen during normal driving.

CAUTION

- If a malfunction occurs in the CVT while driving, the indicator lamp will blink. In this case, immediately park your vehicle in a safe place and follow these procedures: [If the indicator lamp blinks rapidly (once per second), the CVT fluid is overheating.] Park your vehicle in a safe place but do not turn off the engine. Move the selector lever to the “P” (PARK) position and open the bonnet. Keep the engine, idling. After a while, confirm that the indicator lamp stops blinking. It is safe to continue driving if the indicator lamp no longer blinks. If the indicator lamp continues blinking or blinks intermittently, have your vehicle inspected by an authorised MITSUBISHI MOTORS dealer immediately. [If the indicator lamp blinks slowly (once per 2 seconds), the CVT safety device may be operating due to a malfunction.] Have the vehicle inspected by an authorised MITSUBISHI MOTORS dealer immediately.

Operation of the CVT

E00602601554

CAUTION

- Before selecting a position with the engine running and the vehicle stationary, fully depress the brake pedal to prevent the vehicle from creeping. The vehicle will begin to move as soon as the CVT is engaged, especially when the engine speed is high, at fast idle or with the air conditioning operating, the brakes should only be released when you are ready to drive away.
- Depress the brake pedal with the right foot at all times. Using the left foot could cause driver movement delay in case of an emergency.
- To prevent sudden acceleration, never race the engine when shifting from the “P” (PARK) or “N” (NEUTRAL) position.
- Operating the accelerator pedal while the other foot is resting on the brake pedal will affect braking efficiency and may cause premature wear of brake pads.

CAUTION

- Use the selector lever in the correct shift position accordance with driving conditions. Never coast downhill backward with the selector lever in the “D” (DRIVE), “Ds” (DOWNSHIFT & SPORTY DRIVING), “L” (LOW) position or coast forward with the selector lever in the “R” (REVERSE) position.

The engine may stop and the unexpected increase in brake pedal effort and steering wheel effort could lead to an accident.

- Do not race the engine with brake pedal pressed when the vehicle is stationary. This can damage the CVT.

Also, when you depress the accelerator pedal while holding down the brake pedal with the selector lever in the “D” (DRIVE) position, the engine revolutions may not rise as high as when performing the same operation with the selector lever in the “N” (NEUTRAL) position.

Passing acceleration

E00602700112

To gain extra acceleration in “D” (DRIVE) position push the accelerator to the floor. The CVT will automatically downshift.

Uphill/downhill driving

E00603000125

DRIVING UPHILL

The transmission prevents unnecessary upshifts even when the accelerator pedal is released and ensures smooth driving.

DRIVING DOWNHILL

According to the conditions, the transmission will automatically shift to a lower gear ratio to achieve stronger engine braking. This may help reduce your need to use the service brake.

Waiting

E00602801181

For short waiting periods, such as at traffic signals the vehicle can be left in selector lever position and held stationary with the service brake.

For longer waiting periods with the engine running, place the selector lever in the “N” (NEUTRAL) position and apply the parking brake, while holding the vehicle stationary with the service brake.

CAUTION

- Never hold the vehicle stationary while in CVT on a hill with the accelerator, always apply the parking brake and/or service brake.

Parking

E00602900039

To park the vehicle, first bring it to a complete stop, fully engage the parking brake, and then move the selector lever to the “P” (PARK) position.

If you are going to leave the vehicle unattended, always switch off the engine and carry the key.

NOTE

- On a slope, be sure to apply the parking brake before moving the selector lever to the “P” (PARK) position. If you move the selector lever to the “P” (PARK) position before applying the parking brake, it may be difficult to disengage the selector lever from the “P” (PARK) position when next you drive the vehicle, requiring application of a strong force to the selector lever to move from the “P” (PARK) position.

Braking

When the CVT makes no speed change

E00603101312

If the transmission does not change speeds while driving, or your vehicle does not pick up enough speed when starting on an uphill slope, it may be that there is something unusual happening in the transmission, causing a safety device to activate. Have your vehicle checked at an authorised MITSUBISHI MOTORS dealer immediately.

6

Braking

E00607001856

All the parts of the brake system are critical to safety. Have the vehicle serviced by an authorised MITSUBISHI MOTORS dealer at regular intervals according to the service booklet.

CAUTION

- Avoid driving habits that cause heavy braking and never “ride” the brakes by resting your foot on the brake pedal while driving. It causes brake overheating and fade.

Brake system

The service brake is divided into two brake circuits. And your vehicle is equipped with power brakes. If one brake circuit fails, the other is available to stop the vehicle. If your vehicle should lose the power assist for some reason, the brakes will still work. In these situations, even if the brake pedal moves down to the very end of its possible stroke or resists being depressed, keep depressing the brake pedal down harder and further than usual; stop driving as soon as possible and have the brake system repaired at an authorised MITSUBISHI MOTORS dealer.

WARNING

- Do not turn off the engine while your vehicle is in motion. If you turn off the engine while driving, the power assistance for the braking system will stop working and your brakes will not work effectively.
- If the power assist is lost or if either brake hydraulic system stops working properly, have your vehicle checked immediately, take your vehicle to an authorised MITSUBISHI MOTORS dealer immediately.

Warning lamp

The brake warning lamp illuminates to indicate a fault in the braking system. Refer to “Brake warning lamp” on page 5-13.

When brakes are wet

Check the brake system while driving at a low speed immediately after starting, especially when the brakes are wet, to confirm they work normally.

A film of water can be formed on the brake discs or brake drums and prevent normal braking after driving in heavy rain or through large puddles, or after the vehicle is washed. If this occurs, dry the brakes out by driving slowly while lightly depressing the brake pedal.

When driving downhill

It is important to take advantage of the engine braking by shifting to a lower shift position while driving on steep downhill roads in order to prevent the brakes from overheating.

⚠ WARNING

- Do not leave any objects near the brake pedal or let a floor mat slide under it; doing so could prevent the full pedal stroke that would be necessary in an emergency. Make sure that the pedal can be operated freely at all times. Make sure the floor mat is securely held in place.

Brake pads

- New brakes need to be broken-in by moderate use for the first 200 km. Avoid hard braking situations.
- The disc brakes are provided with a warning device which emits a shrieking metallic sound while braking if the brake pads have reached their limit. If you hear this sound, have the brake pads replaced immediately by your MITSUBISHI MOTORS dealer.

⚠ WARNING

- Driving with worn brake pads will make it harder to stop, and can cause an accident.

Hill start assist

E00628001341

The hill start assist makes it easy to start off on a steep uphill slope by preventing the

vehicle from moving backwards. It keeps the braking force for about 2 seconds when you move your foot from the brake pedal to the accelerator pedal.

⚠ CAUTION

- Do not overly rely on the hill start assist to prevent backwards movement of the vehicle. Under certain circumstances, even when hill start assist is activated, the vehicle may move backwards if the brake pedal is not sufficiently depressed, if the vehicle is heavily loaded, or if the road is very steep or slippery.
- The hill start assist is not designed to keep the vehicle stopped in place on uphill slopes for more than 2 seconds.
- When facing uphill, do not rely on using the hill start assist to maintain a stopped position as an alternative to depressing the brake pedal. Doing so could cause an accident.
- Do not perform the following operation while the hill start assist is operating. [Except for vehicles equipped with the keyless operation system] Turn the ignition switch to the “LOCK” or “ACC” position. [Vehicles equipped with the keyless operation system] Put the operation mode in OFF or ACC. The hill start assist could stop operating, which could result in an accident.

To operate

E00628101515

1. Stop the vehicle completely using the brake pedal.
2. On vehicles with M/T, place the gearshift lever into the 1st position. On vehicles with CVT, place the selector lever into the “D” (DRIVE) position.

📖 NOTE

- When reversing on an uphill slope, place the gearshift lever or selector lever into the “R” position.

6

3. Release the brake pedal and the hill start assist will maintain the braking force applied while stopped for approximately 2 seconds.
4. Depress the accelerator pedal and the hill start assist will gradually decrease the braking force as the vehicle starts moving.

📖 NOTE

- The hill start assist is activated when all of the following conditions are met.
 - The engine is running. (The hill start assist will not be activated while the engine is starting or immediately after the engine is started.)

Brake assist system

6

NOTE

- On vehicles with M/T, the gearshift lever is in the following position.
[When starting an uphill slope forwards.]
The gearshift lever is in any position other than “R” (Reverse).
(The hill start assist will operate, even if the gearshift lever is in the “N” (Neutral) position.)
[When starting an uphill slope backwards.]
The gearshift lever is in the “R” (Reverse) position.
(The hill start assist will not operate when the gearshift lever is in the “N” (Neutral) position.)
- On vehicles with CVT, the selector lever is in any position other than “P” (PARK) or “N” (NEUTRAL).
- The vehicle is completely stationary, with the brake pedal depressed.
- The parking brake is released.
- The hill start assist will not operate if the accelerator pedal is depressed before the brake pedal is released.
- The hill start assist also operates when reversing on an uphill slope.
- When the hill start assist activated, you may feel the operation sound or vibration from under the body.
This is a normal result of the hill start assist operation, and does not indicate a problem.

Warning indicator

E00628201486

If an abnormal condition occurs in the system, the indicator will turn on.

 - ASC indicator

CAUTION

- If the warning is turn on, the hill start assist will not operate. Start off carefully.
- Park your vehicle in a safe place and stop the engine.
Restart the engine and check whether the warning indicator went out, in which case the hill start assist is again working normally. If the warning remains displayed or reappears frequently, it is not necessary to stop the vehicle immediately, but the vehicle should be inspected by an authorised MIT-SUBISHI MOTORS dealer.

Brake assist system

E00627001748

The brake assist system is a device assisting drivers who cannot depress the brake pedal firmly such as in emergency stop situations and provides greater braking force.

If the brake pedal is depressed suddenly, the brakes will be applied with more force than usual.

CAUTION

- The brake assist system is not a device designed to exercise braking force greater than its capacity. Make sure to always keep a sufficient distance between your vehicle and a vehicle in front of you without relying too much on the brake assist system.

NOTE

- Once the brake assist system is operational, it maintains great braking force even if the brake pedal is lightly released.
To stop its operation, completely remove your foot from the brake pedal.
- When the brake assist system is in use while driving, you may feel as if the depressed brake pedal is soft, the pedal moves in small motions in conjunction with the operation noise, or the vehicle body and the steering wheel vibrate. This occurs when the brake assist system is operating normally and does not indicate faulty operation. Continue to depress the brake pedal.
- When the anti-lock brake system warning lamp is illuminated, the brake assist system is not functioning.

Emergency stop signal system

E00626001174

This is a device that reduces the possibility of rear end collisions by the rapid and automatic blinking of the hazard warning lamps to alert vehicles approaching from behind during sudden braking. When the emergency stop signal system operates, the hazard warning indicator lamp in the instrument cluster blinks rapidly at the same time.

CAUTION

- If the ABS warning lamp or ASC warning indicator is illuminated, the emergency stop signal system may not operate. Refer to “ABS warning lamp” on page 6-34. Refer to “ASC warning indicator” on page 6-37.

NOTE

- [Activating condition for the emergency stop signal system]
It activates when all of the following conditions are met.
 - The vehicle speed is approximately 55 km/h or higher.

NOTE

- The brake pedal has been depressed, and the system judges that it was sudden braking from the vehicle deceleration and the operating condition of the anti-lock brake system (ABS).

[Deactivating condition for the emergency stop signal system]

It deactivates when one of the following conditions is met.

- The brake pedal is released.
- The hazard warning flasher switch is pressed.
- The system judges that it was not sudden braking from the vehicle deceleration and the operating condition of the anti-lock brake system (ABS).

Anti-lock brake system (ABS)

E00607102623

The anti-lock brake system (ABS) helps prevent the wheels from locking up when braking. This helps maintain vehicle drivability and steering wheel handling.

Driving hints

- Always keep a safe distance from the vehicle in front of you. Even if your vehicle is equipped with the ABS, leave a greater braking distance when:
 - Driving on gravel or snow-covered roads.
 - Driving with tyre chains installed.
 - Driving on uneven road surfaces.
- Operation of ABS is not restricted situations where brakes are applied suddenly. This system may also prevent the wheels from locking when you drive over manholes, steel roadwork plates, road markings, or any uneven road surface.
- When the ABS is in use, you may feel the brake pedal pulsation and the vibrations of the vehicle body and steering wheel. It may also feel as if the pedal resists being pressed.

In this situation, simply hold the brake pedal down firmly. Do not pump the brake, which will result in reduced braking performance.
- An operation noise is emitted from the engine compartment or feel a shock from the brake pedal when start driving immediately after starting the engine. These are normal sound or operation that the ABS makes when performing a self-check. It does not indicate a malfunction.

Anti-lock brake system (ABS)

- The ABS can be used after the vehicle has reached a speed over approximately 10 km/h. It stops working when the vehicle slows below approximately 5 km/h.

CAUTION

- The ABS cannot prevent accidents. It is your responsibility to take safety precautions and to drive carefully.
- To prevent failure of the ABS, be sure all 4 wheels and tyres are the same size and the same type.
- Do not install any aftermarket limited slip differential (LSD) on your vehicle. The ABS may stop functioning properly.

6

ABS warning lamp

E00607201252

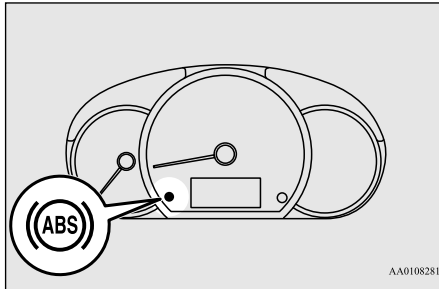

AA0108281

If there is a malfunction in the system, the ABS warning lamp will come on.

6-34 Starting and driving

Under normal conditions, the ABS warning lamp comes on when the ignition switch is turned to the “ON” position or the operation mode is put in ON and goes off a few seconds later.

CAUTION

- Any of the following indicates that the ABS is not functioning and only the standard brake system is working. (The standard brake system is functioning normally.) If this happens, please contact your nearest authorised MITSUBISHI MOTORS dealer for inspection.
 - When the ignition switch is turned to the “ON” position or the operation mode is put in ON, the warning lamp does not come on or it remains on and does not go off.
 - The warning lamp comes on while driving

If the warning lamp illuminates while driving

E00607302511

If only the ABS warning lamp illuminates

Avoid hard braking and high-speed driving. Stop the vehicle in a safe place. Restart the engine and check to see whether the lamp goes out after a few minutes driving;

if it then remains off during driving, there is no problem.

However, if the warning lamp do not disappear, or if they come on again when the vehicle is driven, have the vehicle checked by an authorised MITSUBISHI MOTORS dealer as soon as possible.

If the ABS warning lamp and brake warning lamp illuminate at the same time

The ABS and brake force distribution function may not work, so hard braking could make the vehicle unstable. Avoid hard braking and high-speed driving. Stop the vehicle in a safe place and contact an authorised MITSUBISHI MOTORS dealer.

After driving on icy roads

E00618800206

After driving on snow or icy roads, remove any snow and ice which may have be left around the wheels. On vehicles that have an ABS, be careful not to damage the wheel speed sensors (A) or the cables located at each wheel.

Electric power steering system (EPS)

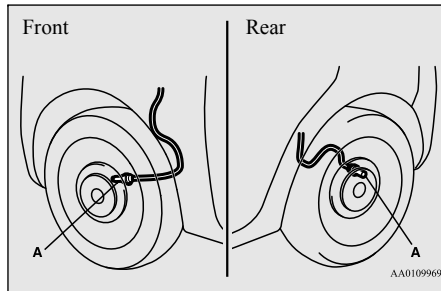

Electric power steering system (EPS)

E00629201395

The power steering system operates while the engine is running. It helps reduce the effort needed to turn the steering wheel.

The power steering system has mechanical steering capability in case the power assist is lost. If the power assist is lost for some reason, you will still be able to steer your vehicle, but you will notice it takes much more effort to steer. If this happens, have your vehicle inspected at an authorised MITSUBISHI MOTORS dealer.

WARNING

- Do not stop the engine while the vehicle is moving. Stopping the engine would make the steering wheel extremely hard to turn, possibly resulting in an accident.

NOTE

- During repeated full-lock turning of the steering wheel (for example, while you are manoeuvring the vehicle into a parking space), a protection function may be activated to prevent overheating of the power steering system. This function will make the steering wheel gradually harder to turn. In this event, limit your turning of the steering wheel for a while. When the system has cooled down, the steering effort will return to normal.
- If you turn the steering wheel while the vehicle is stationary with the headlamps on, the headlamps may become dim. This behaviour is not abnormal. The headlamps will return to their original brightness after a short while.

Electric power steering system warning lamp

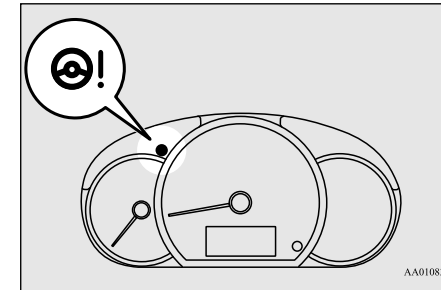

6

If there is a malfunction in the system, the warning lamp will come on.

Under normal conditions, the warning lamp comes on when the ignition switch is turned to the "ON" position or the operation mode is put in ON, and goes off after the engine has started.

CAUTION

- If the warning lamp comes on while the engine is running, have the vehicle inspected by an authorised MITSUBISHI MOTORS dealer as soon as possible. It may become harder to turn the steering wheel.

Active stability control (ASC)

Active stability control (ASC)

E00616700445

The active stability control (ASC) takes overall control of the anti-lock brake system, traction control function and stability control function to help maintain the vehicle's control and traction. Please read this section in conjunction with the page on the anti-lock brake system, traction control function and stability control function.

6

Anti-lock brake system (ABS) → P.6-33

Traction control function → P.6-36

Stability control function → P.6-36

CAUTION

- Do not over-rely on the ASC. Even the ASC cannot prevent the natural laws of physics from acting on the vehicle. This system, like any other system, has limits and cannot help you to maintain traction and control of the vehicle in all circumstances. Reckless driving can lead to accidents. It is the driver's responsibility to drive carefully. This means into account the traffic, road and environmental conditions.
- Be sure to use the same specified type and size of tyre on all 4 wheels. Otherwise, the ASC may not work properly.

CAUTION

- Do not install any aftermarket limited slip differential (LSD) on your vehicle. The ASC may stop functioning properly.

NOTE

- An operation noise may be emitted from the engine compartment in the following situations. The sound is associated with checking the operations of the ASC. At this time, you may feel a shock from the brake pedal if you depress it. These do not indicate a malfunction.
 - When the ignition switch is turned to the "ON" position or the operation mode is put in ON.
 - When the vehicle is driven for a while after the engine is turned on.
- When the ASC is activated, you may feel a vibration in the vehicle body or hear a whining sound from the engine compartment. This indicates that the system is operating normally. It does not indicate a malfunction.
- When the anti-lock brake system warning lamp is illuminated, the ASC is not active.

Traction control function

E00619000133

On slippery surfaces, the traction control function prevents the drive wheels from spinning excessive, thus helping the vehicle to

start moving from a stopped condition. It also provides sufficient driving force and steering performance as the vehicle turns while pressing the acceleration pedal.

CAUTION

- When driving a vehicle on a snowy or icy road, be sure to install snow tyres and drive the vehicle at moderate speeds.

Stability control function

E00619100017

The stability control function is designed to help the driver maintain control of the vehicle on slippery roads or during rapid steering maneuvers. It works by controlling the engine output and the brake on each wheel.

NOTE



- The stability control function operates at speeds of about 15 km/h or higher.

"ASC OFF" switch

E00619201637

The ASC is automatically activated when the ignition switch is turned to the "ON" position or the operation mode is put in ON. You can deactivate the system by pressing down the "ASC OFF" switch for 3 seconds or longer.

Active stability control (ASC)

When the ASC is deactivated, the  indicator will turn on. To reactivate the ASC, momentarily press the “ASC OFF” switch; the  indicator is turned off.

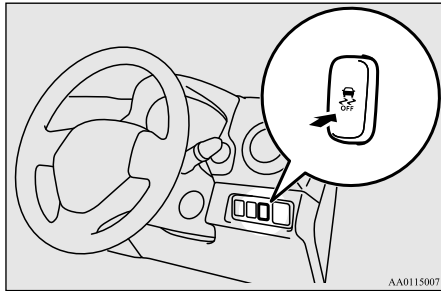

AA0115007

CAUTION

- For safety reasons, the “ASC OFF” switch should be operated when your vehicle is stopped.
- Be sure to keep the ASC on while driving in normal circumstances.

NOTE

- When moving out of mud, sand or fresh snow, pressing the accelerator pedal may not allow the engine speed to increase. In such situations, temporarily turning off the ASC with the “ASC OFF” switch will make it easier to move out your vehicle.

NOTE



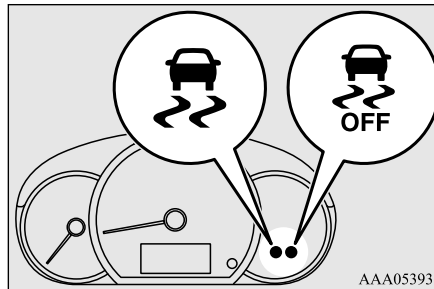

- Using the “ASC OFF” switch turns off both the stability control function and the traction control function.
- If you continue to press the “ASC OFF” switch after the ASC is turned off, the “mistaken operation protection function” will activate and the ASC will turn back on.
- If your vehicle is equipped with Forward Collision Mitigation System (Low speed range) (FCM-LS), when the ASC is deactivated, the  indicator lamp will turn on and the following systems will not operate.
 - Forward Collision Mitigation System (Low speed range) (FCM-LS)
 - Radar sensing misacceleration Mitigation System (RMS) (Forward)

ASC operation indicator or ASC OFF indicator

E00619301999



AAA053931

-  - ASC indicator
-  - The indicator will blink when the ASC is operating.
-  - ASC OFF indicator
-  - This indicator will turn on when the ASC is turned off with the “ASC OFF” switch.

CAUTION

- When  indicator blinks, ASC is operating, which means that the road is slippery or that your vehicle’s wheels are beginning to slip. If this happens, drive slower with less accelerator input.

6

NOTE



- The  indicator may turn on when you start the engine. This means that the battery voltage momentarily dropped when the engine was started. It does not indicate a malfunction, provided that the display goes out immediately.

ASC warning indicator

E00619400629

If an abnormal condition occurs in the system, the indicators will turn on.

Cruise control*

-  - ASC indicator
-  - ASC OFF indicator

6

CAUTION

- The system may be malfunctioning. Park your vehicle in a safe place and stop the engine. Restart the engine and check whether the indicator go out. If they go out, there is no abnormal condition. If they do not go out or appears frequently, it is not necessary to stop the vehicle immediately, but have your vehicle checked at an authorised MITSUBISHI MOTORS dealer.

Towing

E0062440076

CAUTION

- When towing the vehicle with only the front wheels or only the rear wheels raised off the ground, do not place the ignition switch in the “ON” position or do not put the operation mode in ON. Placing the ignition switch in the “ON” position or putting the operation mode in ON could cause the ASC to operate, resulting in an accident. Note that the correct towing method depends on the transmission type and the vehicle’s drive configuration. For details, refer to “Towing” on page 8-17.

Cruise control*

E00609102409

Cruise control is an automatic speed control system that keeps a set speed. It can be activated at approximately 40 km/h or more.

CAUTION

- When you do not wish to drive at a set speed, turn off the cruise control for safety.
- Do not use cruise control when driving conditions will not allow you to stay at the same speed, such as in heavy traffic or on roads that are winding, icy, snow-covered, wet, slippery, on a steep downhill slope.

NOTE

- Cruise control may not be able to keep your speed on uphill or downhill.
- Your speed may decrease on a steep uphill. You may use the accelerator pedal if you want to stay at your set speed.
- Your speed may increase to more than the set speed on a steep downhill. You have to use the brake to control your speed. As a result, the set speed driving is deactivated.

Cruise control switches

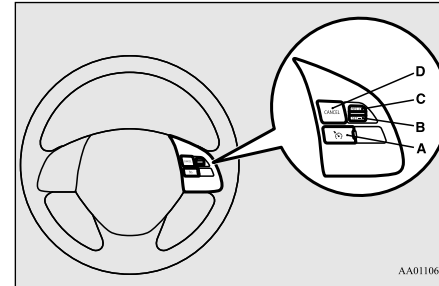

AA0110608

A- CRUISE CONTROL ON/OFF switch

Used to turn on and off the cruise control.

B- SET - switch

Used to reduce the set speed and to set the desired speed.

C- RES + switch

Used to increase the set speed and to return to the original set speed.

D- CANCEL switch

Used to deactivate the set speed driving.

NOTE

- When operating the cruise control switches, press the cruise control switches correctly. The set speed driving may be deactivated automatically if two or more switches of the cruise control are pressed at the same time.

To activate

E00609302557

1. With the operation mode in ON, press the CRUISE CONTROL ON/OFF switch (A) to turn on the cruise control. The indicator lamp in the meter cluster will come on.

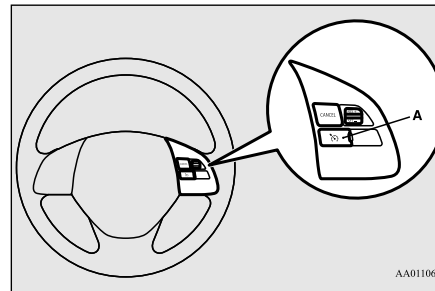

Indicator lamp



2. Accelerate or decelerate to your desired speed, then push down and release the SET - switch (B) when the indicator lamp is illuminated. The vehicle will then maintain the desired speed.

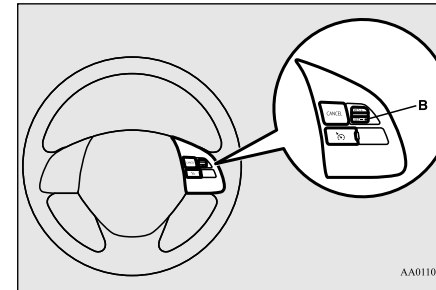

AA0110624

NOTE

- When you release the SET - switch (B), the vehicle speed will be set.

To increase the set speed

E00609401900

There are two ways to increase the set speed.

Cruise control*

RES + switch

Push up and hold the RES + switch (C) while driving at the set speed, and your speed will then gradually increase.

When you reach your desired speed, release the switch. Your new cruising speed is now set.

6

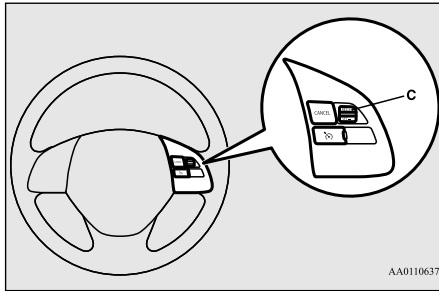

To increase your speed in small amounts, push up the RES + switch (C) for less than approximately 1 second and release it. Each time you press the RES + switch (C), your vehicle will go approximately 1.6 km/h faster.

Accelerator pedal

While driving at the set speed, use the accelerator pedal to reach your desired speed and then push down the SET - switch (B) and release the switch momentarily to set a new desired cruising speed.

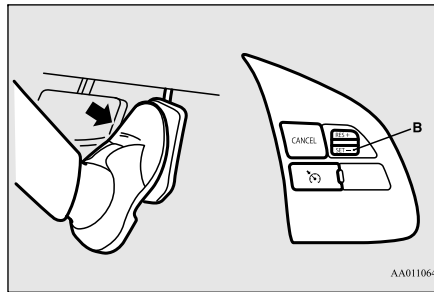

To decrease the set speed

E00609501839

There are two ways to decrease the set speed.

SET - switch

Push down and hold the SET - switch (B) while driving at the set speed, and your speed will slow down gradually.

When you reach your desired speed, release the switch. Your new cruising speed is now set.

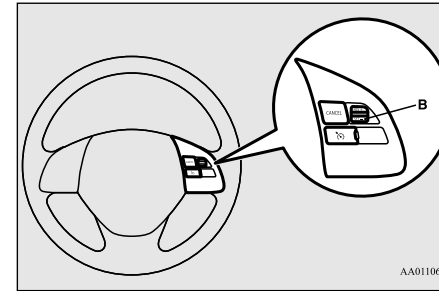

To slow down your speed in small amounts, push down the SET - switch (B) for less than approximately 1 second and release it. Each time you push down the SET - switch (B), your vehicle will slow down by approximately 1.6 km/h.

Brake pedal

While driving at the set speed, use the brake pedal, which disengages the cruise control, then push down the SET - switch (B) and release the switch momentarily to set a new desired cruising speed.

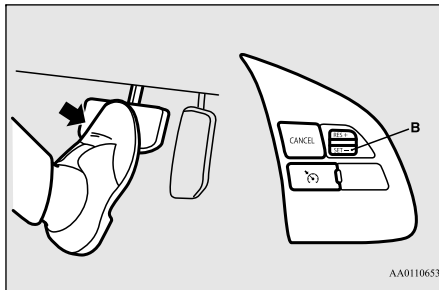

To temporarily increase or decrease the speed

E00609600194

To temporarily increase the speed

Depress the accelerator pedal as you would normally. When you release the pedal, you will return to your set speed.

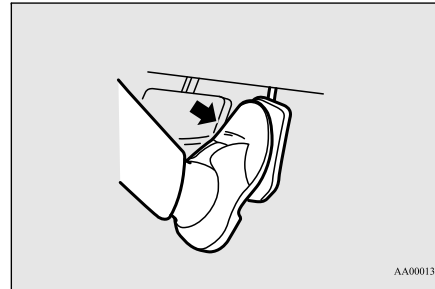

NOTE

- In some driving conditions, the set speed driving may be deactivated. If this happens, refer to “To activate” on page 6-39 and repeat the speed setting procedure.

To temporarily decrease the speed

Depress the brake pedal to decrease the speed. To return to the previously set speed, push up the RES + switch (C). Refer to “To resume the set speed” on page 6-42.

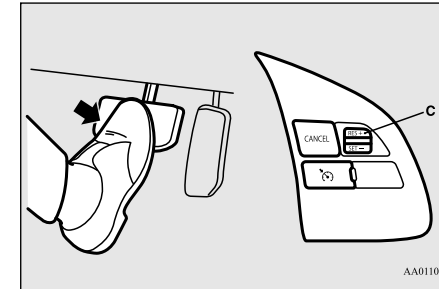

6

To deactivate

E00609702812

The set speed driving can be deactivated as follows:

- Press the CRUISE CONTROL ON/OFF switch (A) (Cruise control will be turned off.)
- Press the CANCEL switch (D).
- Depress the brake pedal.

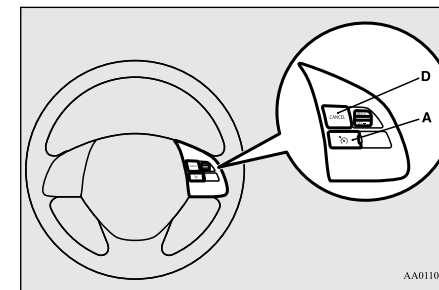

Forward Collision Mitigation System (Low speed range) (FCM-LS)*

The set speed driving is deactivated automatically in any of the following ways.

- When your speed slows to approximately 15 km/h or more below the set speed because of a hill, etc.
- When your speed slows to approximately 40 km/h or less.
- When the active stability control (ASC) starts operating.
Refer to “Active stability control (ASC)” on page 6-36.

6

! WARNING

- **Although the set speed driving will be deactivated when shifting to the “N” (NEUTRAL) position, never move the selector lever to the “N” (NEUTRAL) position while driving. You would have no engine braking and could cause a serious accident.**

Also, the set speed driving may be deactivated as follow:

- When the engine speed rises and approaches the tachometer’s red zone (the red-coloured part of the tachometer dial).

! CAUTION

- When the set speed driving is deactivated automatically in any situation other than those listed above, there may be a system malfunction.
Press the CRUISE CONTROL ON/OFF switch to turn off the cruise control and have your vehicle inspected by an authorised MITSUBISHI MOTORS dealer.

To resume the set speed

E00609802015

If the set speed driving is deactivated by the condition described in “To deactivate” on page 6-41, you can resume the previously set speed by push up the RES + switch (C) while driving at a speed of approximately 40 km/h or higher.

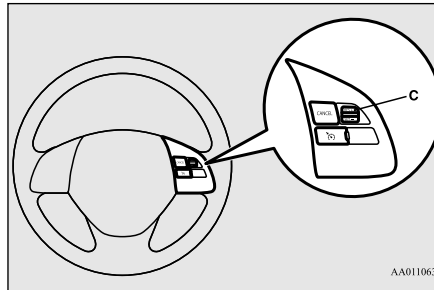

Under either of the following conditions, however, using the switch does not allow you

to resume the previously set speed. In these situations, repeat the speed setting procedure:

- The CRUISE CONTROL ON/OFF switch is pressed.
- The operation mode is put in OFF.
- Indicator lamp goes off.

Forward Collision Mitigation System (Low speed range) (FCM-LS)*

E00635101201

The FCM-LS is designed to help reduce the risk of a collision with a vehicle straight-ahead of your vehicle when driving at low speed (from approximately 5 km/h to 30 km/h). The FCM-LS uses a laser radar (A) to determine the distance to a vehicle in front and relative speed to that vehicle. The FCM-LS is not designed as an automatic driving system or as a collision avoidance system.

Forward Collision Mitigation System (Low speed range) (FCM-LS)*

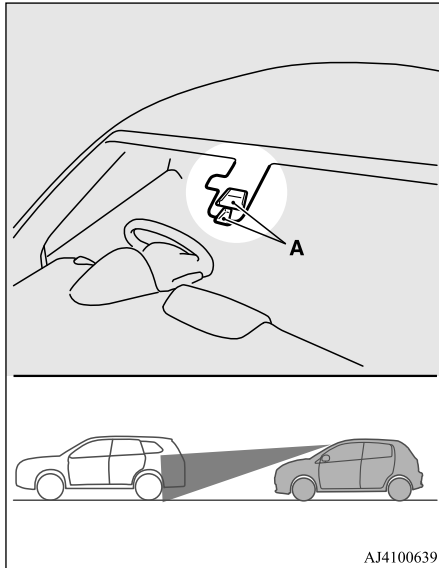

When your vehicle is approaching a vehicle straight-ahead in your path and the FCM-LS judges that there is the risk of a collision, the system will give audible and visual warnings. And the system will apply emergency braking to reduce the severity of the collision. In addition, the system will stop your vehicle to avoid the collision depending on the situation, when the relative speed to the vehicle ahead is less than approximately 15 km/h.

⚠ WARNING

- A driver is responsible for driving safely. The FCM-LS is the system to mitigate collision-caused damages or to avoid collisions as much as possible. The system is not intended to compensate for driver's loss of attention to the front during driving due to distraction or carelessness or supplement a drop in visibility due to the rain and fog. It is never a substitute for your safe and careful driving. Always be ready to apply the brakes manually.
- The FCM-LS works to avoid frontal collisions as much as possible. However, the effect of its operation varies depending on situations and conditions, such as driving conditions, road conditions, and steering, acceleration and braking operations, so that the performance the function can deliver is not always the same. If your vehicle is in danger of collision, take all necessary collision-evading actions, such as depressing the brake pedal strongly regardless of whether the system is activated or not.
- Under certain circumstances, the FCM-LS may not operate or may not detect correctly a vehicle in front. Never rely on the FCM-LS to prevent a collision. Doing so could lead to serious injury in the event of a collision.

⚠ WARNING

- When the FCM-LS operates, the automatic brake may strongly apply. To reduce the risk of serious injury or death in the event of an accident or sudden stop, make sure the driver and passengers always wear the seat belts properly while the vehicle is in motion.
- Do not try to confirm the operation of the FCM-LS. In certain situations, this can cause an accident resulting in serious injury or death.

⚠ CAUTION





- Do not use the FCM-LS as a normal braking.

6

Forward Collision Mitigation System (Low speed range) (FCM-LS)*

The FCM-LS operates as follows.

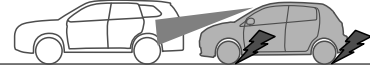
6

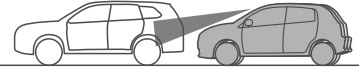
	Situation	Automatic brake	Indicator lamp	Buzzer
1	<p>The FCM-LS system detects a forward vehicle.</p>  <p>AJM103071</p>	Does not operate	Turn off	No sounds
2	<p>If the system judges that there is a risk of your vehicle colliding with a vehicle in front, the indicator lamp blinks and audible alarms warns you of the potential hazard.</p>  <p>AJM103084</p>	Does not operate	 Blinks	Intermittent beeping sound
3	<p>If the system judges that the collision is highly unavoidable, it will automatically apply emergency braking to reduce the severity of the collision and, if possible, to avoid the collision.</p> <p>After your vehicle was stopped by the FCM-LS, the automatic brake applies continuously for approximately 2 seconds with blinking the indicator lamp and intermittent beeping sounds.</p>  <p>AJM103097</p>	Operate	 Blinks	Intermittent beeping sound
4	<p>After your vehicle was stopped by the FCM-LS, the automatic brake is released approximately 2 seconds later.</p>  <p>AJM103101</p>	Release	Turn off	No sounds

Forward Collision Mitigation System (Low speed range) (FCM-LS)*



 **NOTE**

- Depending on the situation, blinking a indicator lamp, audible alarms (2) and automatic brake (3) may start at the same time.
- Stop lamps are illuminated during automatic braking.

Forward Collision Mitigation System (Low speed range) (FCM-LS)*

6

CAUTION

- If the brake pedal is not depressed within 2 seconds after your vehicle has been stopped by the FCM-LS, the brakes activated by the FCM-LS will automatically be released. Apply the brakes as necessary to keep your vehicle stationary.
- The FCM-LS will not operate in the following situations.
 - When the operation mode is in any mode other than ON.
 - The FCM-LS and Radar sensing misacceleration Mitigation System (RMS) (Forward) is OFF.
 - The Active Stability Control system (ASC) is OFF.
 - When the  and  indicator lamps illuminate at the same time.
 - When the  indicator lamp blinks.
 - When the selector lever is in the “P” (PARK) or “R” (REVERSE) position.
- The FCM-LS operates to reduce the collision with the vehicle ahead. Depending on the situation, the FCM-LS may operate for a motorcycle, a bicycle, a pedestrian or a wall etc., but these are not objects of the activating the FCM-LS.
- The FCM-LS may not operate in certain situations. Some of these include:
 - Under adverse weather conditions. (rain, strong winds, snow, sand storms, etc.)
 - When a vehicle cuts into your path at a close distance.

CAUTION

- When a vehicle suddenly cuts in front of your vehicle.
- When only the part of a vehicle ahead is within the detecting range of the laser radar.
- When the vehicle in front is offset to the left or right.
- When the your vehicle changed lanes, and your vehicle approached immediately behind the vehicle ahead.
- When a vehicle ahead or an oncoming vehicle is splashing water, snow or dirt.
- When the windscreen is dirty.
- When using a windscreen washer.
- When the laser radar becomes extremely hot.
- Immediately after engine starting.
- When driving on a curve.
- During the driving that is rapid acceleration/deceleration.
- When driving on a road with alternating up and down steep slopes.
- When driving on a bumpy or rough road.
- When the system judges driver’s steering, accelerating, braking or gear shifting actions as evasive actions to avoid collision.
- When the vehicle body is extremely inclined by carrying heavy loads or improper adjustment of the tyre pressure.
- When the driving is unstable due to an accident or trouble.
- The battery is weak or dead.

CAUTION

- The FCM-LS may be cancelled when the system recognizes driver’s steering or accelerating actions as evasive actions or when the obstacle moves out of the detecting range area of the laser radar.
- The FCM-LS may not operate because the laser radar cannot detect a front vehicle correctly as follows.
 - Vehicle towing a trailer etc.
 - A freight trailer that is not carrying a container.
 - Vehicle that has a protruding load from the carrier.
 - Vehicle with the low height.
 - Vehicle that has an extremely high ground clearance.
 - Vehicle that is extremely stained.
 - Vehicle that has a dark color.
 - Vehicle that is covered with snow.
 - Vehicle that has a large glass surface.
 - Vehicle that does not have reflectors (lamp reflector) or the position of the reflector is low.
 - Vehicle that has a specific shape such as the carrier car.
- In certain situations, though there is little or no risk of a collision, the FCM-LS may operate.
Examples include:

⚠ CAUTION

- When there is a road side object (B) that reflects the radar sensor signal, such as a road sign.

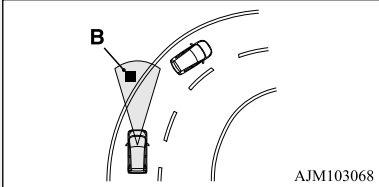

AJM103068

- When quickly approaching a vehicle ahead to overtake it.
- When a vehicle cuts into your path at a close distance.
- When your vehicle changed lanes, and your vehicle approached immediately behind the vehicle ahead.
- When crossing a narrow iron bridge.
- When passing through a low gate or a narrow gate.
- When there are metallic objects, steps or projections on the road surface.
- When passing through an electronic toll collection gate.
- When driving under an overpass or pedestrian bridge.
- When driving in a narrow tunnel.
- When driving in a parking structure.
- When approaching a slope where the incline changes significantly.
- When trying to stop your vehicle very close to a vehicle or an object in front.

⚠ CAUTION

- When passing a vehicle or an object closely.

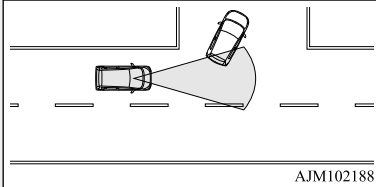

AJM102188

- When a vehicle in the next lane becomes positioned directly in front of your vehicle due to winding road conditions.

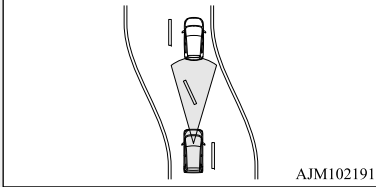

AJM102191

- When a vehicle cuts into your path in the detecting range of the laser radar.
- When an oncoming vehicle passes with a curve.
- When passing through a plastic curtain etc.
- When there are a long objects such as a skis on a roof carrier in the detective range of the laser radar.
- When passing through the mass of the steam, fog or smoke.
- The FCM-LS should be turned off if any of following situations occur:
 - When using an automatic car wash.

⚠ CAUTION

- When your vehicle's wheels are driven by the engine on a lift.
- When your vehicle is towed.
- When your vehicle is carried on a truck.
- When enjoying sports driving on a circuit.
- When your vehicle is on a chassis dynamometer or free rollers.
- When the tyre pressure is not proper.
- When tyre chains are installed.

📖 NOTE

- When depressing the brake pedal while automatic braking is applied, the brake pedal will feel firm. This is normal. Depress the brake pedal harder to apply greater braking force.
- During the automatic braking, operating sounds may be heard. This is normal.

Forward Collision Mitigation System (Low speed range) (FCM-LS)*

Forward Collision Mitigation System (Low speed range) (FCM-LS) and Radar sensing misacceleration Mitigation System (RMS) (Forward) OFF switch

E00651400029

6

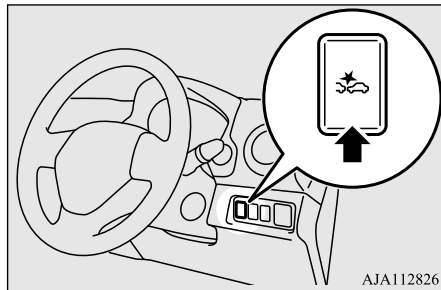

This switch is used to turn on or off the FCM-LS and RMS (Forward).



To turn on/off the system

Every time the operation mode is turned to "ON", the FCM-LS and RMS (Forward) will automatically be turned on.

To turn off the system, press and hold the switch approximately 3 seconds or more. The

 indicator lamp will illuminate to indicate that the system has stopped operating. To reactivate the system, press the switch again; the  indicator lamp is turned off.

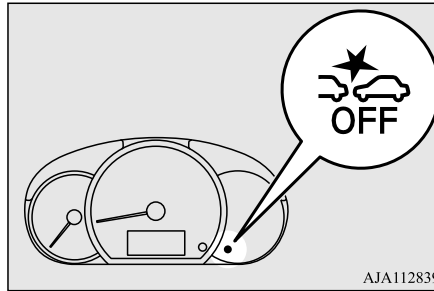

CAUTION

- For safety, operate the switch with the vehicle stationary.

Laser radar

E00651500033

The laser radar (A) is located inside the windscreen as shown in the illustration.

The laser radar is used in combination with FCM-LS and Radar sensing misacceleration Mitigation System (RMS) (Forward).

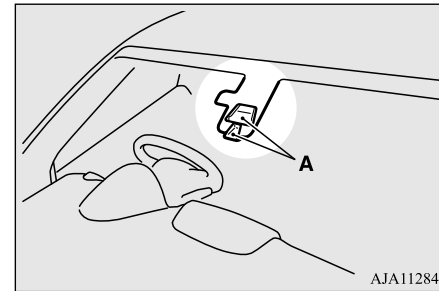

CAUTION

- Improperly handling the system components may result in such problems as degraded laser radar performance and ultimately in an accident. Be sure to take the following precautions to keep the system in good operating conditions.
 - Avoid impacting the laser radar or its surrounding area.
 - Do not modify the laser radar or its surrounding area.

CAUTION

- Always clean the laser radar portion of the windscreen.
- Do not put a sticker or an infrared rays cut film on the laser radar portion of the windscreen or its surrounding area.
- When replacing windscreen wipers or wiper blade, use the MITSUBISHI MOTORS genuine parts.
- Always use tyres of the same size, same type and same brand, and which have no significant wear differences.
- Do not modify the vehicle's suspensions.
- If the windscreen of the laser radar portion is cracks or scratches, the laser radar cannot detect a front vehicle or an obstacle correctly, and could result in a serious accident. In such situations, turn off the FCM-LS and RMS (Forward), have your vehicle inspected as soon as possible at an authorised MITSUBISHI MOTORS dealer.
- The laser radar irradiates infrared rays when the operation mode is in ON. Do not look into the infrared irradiation portion using the optical goods such as magnifying glasses. Doing so might damage your eyes in infrared rays.

Laser radar specifications

Laser classification

Max average power	45 mW
Pulse duration	33 ns
Wavelength	905 nm
Divergent angle (horizon x vertical)	28° x 12°

Laser classification label



Laser explanatory label

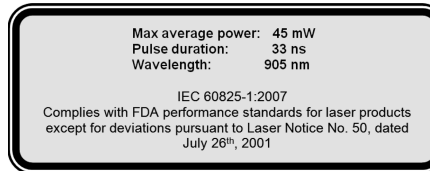

Forward Collision Mitigation System (Low speed range) (FCM-LS) and Radar sensing misacceleration Mitigation System (RMS) (Forward) indicator lamp

E00651600021

These lamps are used in FCM-LS and RMS (Forward).

Normally these lamps illuminate when the operation mode is put in ON, and go off after the engine has started.

6

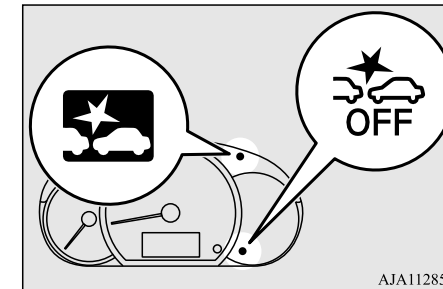

AJA112855

 FCM-LS and RMS (Forward) operation indicator lamp



This indicator lamp will blink when the FCM-LS or RMS (Forward) is operating.

Forward Collision Mitigation System (Low speed range) (FCM-LS)*

 FCM-LS and RMS (Forward) OFF indicator lamp

This indicator lamp will turn on when the FCM-LS and RMS (Forward) are turned off with the FCM-LS and RMS (Forward) OFF switch.

CAUTION

- In the following cases, the FCM-LS and RMS (Forward) may be malfunctioning. Have the system checked as soon as possible at an authorised MITSUBISHI MOTORS dealer.
 - Even when the operation mode is put in ON, the indicator lamps do not come on.
 - After the engine has started, the indicator lamps stay on.
- If the  and  indicator lamp illuminate at the same time, the FCM-LS and RMS (Forward) will not work normally. Park your vehicle in a safe place and stop the engine. Restart the engine and check whether the indicator lamps go off. If the indicator lamps do not go off, or if it comes on again, have the system checked as soon as possible at an authorised MITSUBISHI MOTORS dealer.

NOTE

- If the Active Stability Control (ASC) system is turned off, the FCM-LS and RMS (Forward) will not operate, and the  OFF indicator lamp illuminates.

NOTE

- When front of the laser radar is blocked in the load of the roof.

If the FCM-LS and RMS (Forward) OFF indicator lamp blinks

The laser radar cannot detect a forward vehicle or obstacle, because the laser radar portion of the windscreen is dirty and freezes and there is a foreign material.

In such condition, the FCM-LS and RMS (Forward) will not work correctly.

Remove a dirt, freezing or foreign material of the windscreen.

If the indicator lamp does not disappear after having cleaned the windscreen, have the vehicle checked by an authorised MITSUBISHI MOTORS dealer as soon as possible.

NOTE

- In the following cases, the  indicator lamp may blink, but is not abnormal.
 - When starting the engine with the bonnet left open.
 - When front of the laser radar is blocked by a wall or a structure near a windscreen.

Radar sensing misacceleration Mitigation System (RMS) (Forward)*

E00651700022



The RMS (Forward) operates to prevent sudden starts and mitigate collision-caused damages by suppressing the engine output for up to approximately 5 seconds when the system judges that the system is detected the vehicle or obstacles within approximately 4 m in front your vehicle and judges that accelerator pedal was depressed promptly and too strongly such as misoperation of it. This system operates when the vehicle is at stop or moving forward at speed less than approximately 10 km/h.

When the RMS (Forward) operates, the  indicator lamp blinks in the instrument cluster, and the buzzer sounds intermittently.

Following parts are used in combination with Forward Collision Mitigation System (Low speed range) (FCM-LS) and RMS (Forward). For details, see these sections of this manual:

6

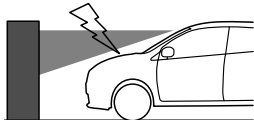
- Laser radar → P.6-48
- FCM-LS and RMS (Forward) operation indicator lamp → P.6-49
- FCM-LS and RMS (Forward) OFF indicator lamp → P.6-49

Situation	Indicator lamp	Buzzer
<p>When an obstacle is detected in front of your vehicle with the selector lever in the “D” (DRIVE), “Ds” (DOWNSHIFT & SPORTY DRIVING) or “L” (LOW) position, if the accelerator pedal is depressed promptly and too strongly, the engine output is suppressed for up to approximately 5 seconds.</p>  <p>AJM103055</p>	 <p>Blinks</p>	<p>Intermittent beeping sound</p>



⚠ WARNING

- **Do not overly rely on the RMS (Forward). It is never a substitute for your safe and careful driving. Always be careful to operate the accelerator pedal perceiving the environmental conditions. Misoperation can lead to a serious accident.**
- **The RMS (Forward) does not have a brake function. Even if the system operates, the vehicle will start to creep if you do not depress the brake pedal. Depress the brake pedal according to the environmental condition.**
- **Depending on the situation, the system does not operate even if the vehicle or the obstacle in front your vehicle and this may cause the vehicle to start suddenly and lead to a serious accident.**
- **If the vehicle is trapped in the railway crossing because the system is activated as the crossing barrier is misrecognised as an obstacle, escape from the railway crossing without any panic by one of the following methods.**
 - **Release the foot from the accelerator pedal and lightly depress the pedal again.**
 - **Turn the system OFF. (Continuously press the FCM-LS and RMS (Forward) OFF switch for more than 3 seconds.)**
 - **Continuously depress the accelerator pedal for more than 5 seconds.**
 - **Repeat to press the accelerator pedal quickly to its full stroke more than 3 times.**

⚠ WARNING

- **Do not perform inspection of the system operation on your own. Depending on the situation, this may cause the system to not operate properly and lead to a serious accident.**

⚠ CAUTION

- The RMS (Forward) does not operate in the following conditions:
 - The operation mode is other than ON.
 - The RMS (Forward) is turned off with the FCM-LS and RMS (Forward) OFF switch.
 - The Active Stability Control system (ASC) is turned off with the ASC OFF switch.
 - The  and  indicator lamp illuminate at the same time.
 - The  indicator lamp blinks.
 - The selector lever is set to the “P” (PARK), “R” (REVERSE) or “N” (NEUTRAL) position.
- The RMS (Forward) operates to the obstacles such as a vehicle ahead or a wall. It sometimes happens that a motorcycle, bicycle or pedestrian are detected as obstacles, but these are not the object of the RMS (Forward).
- The RMS (Forward) may not operate in the following conditions.
 - Under adverse weather conditions. (rain, strong winds, snow, sand storms, etc.)

⚠ CAUTION

- When a vehicle cuts into your path at a close distance.
- When only a part of the obstacle is within the detecting range of the laser radar.
- When a vehicle ahead or an oncoming vehicle is splashing water, snow or dirt.
- When the windscreen is dirty.
- When using a windscreen washer.
- When the laser radar becomes extremely hot.
- Immediately after engine starting.
- When driving on a curve.
- When driving on a road with alternating up and down steep slopes.
- When driving on a bumpy or rough road.
- When the system judges driver’s steering or gear shifting actions as evasive actions to avoid collision.
- For a short period after the system judges the repeated depression of the accelerator pedal at a few seconds interval as a release operation.
- When the vehicle body is extremely inclined by carrying heavy loads or improper adjustment of the tyre pressure.
- When the driving is unstable due to an accident or trouble.
- The battery is weak or dead.

⚠ CAUTION

- The RMS (Forward) may be cancelled when the system recognizes driver's steering actions as evasive actions or when the obstacle moves out of the detecting range of the laser radar.
- The RMS (Forward) may not operate because the laser radar cannot detect the front vehicle or obstacle as follows.
 - Obstacle that infrared rays are permeabilized, such as a fence with large mesh, glass etc.
 - Obstacles that have the shape of the pole such as the road marker or the streetlight.
 - Obstacles that are not vertical to the ground.
 - Obstacles that are not at right angles to vehicle traveling direction.
 - A wall surface is not flat.
 - Vehicle or obstacle with the low height.
 - Vehicle or obstacle that is extremely stained.
 - Vehicle or obstacle that has a dark color.
 - Vehicle or obstacle that is covered with snow.
 - Vehicle towing a trailer etc.
 - A freight trailer that is not carrying a container.
 - Vehicle that has a protruding load from the carrier.
 - Vehicle that has an extremely high ground clearance.
 - Vehicle that has a large glass surface.

⚠ CAUTION

- Vehicle that does not have reflectors (lamp reflector) or the position of the reflector is low.
- Vehicle that has a specific shape such as the carrier car.
- The RMS (Forward) may be triggered operate in the following situations.
 - When there is a road side object in a curb or an intersection.
 - When your vehicle joins the main line.
 - When there are metallic objects, steps or projections on the road surface.
 - When an electronic toll collection gate, parking gate or railway barrier is raised imperfectly.
 - When start a vehicle on an uphill slope.
 - When running the road, the gradient changes suddenly.
 - When passing through the mass of the steam, fog or smoke.
 - When driving in close to the vehicle ahead.
 - When passing close to the vehicle or an obstacle.
 - When passing through a plastic curtain etc.
 - When there are a long objects such as a skis on a roof carrier in the detective range of the laser radar.
- Turn off the RMS (Forward) with the FCM-LS and RMS (Forward) OFF switch beforehand when the vehicle is placed in any of the following situations as the system can operate unexpectedly.

⚠ CAUTION

- When using an automatic car wash.
- When your vehicle's wheels are driven by the engine on a lift.
- When your vehicle is towed.
- When your vehicle is carried on a truck.
- When enjoying sports driving on a circuit.
- When your vehicle is on a chassis dynamometer or free rollers.
- When the tyre pressure is not proper.
- When tyre chains are attached.

To turn on/off the Radar sensing misacceleration Mitigation System (RMS) (Forward)

E00651800023

The RMS (Forward) is automatically turned ON by setting the operation mode to ON. If you want to turn off a system, refer to “Forward Collision Mitigation System (Low speed range) (FCM-LS) and Radar sensing misacceleration Mitigation System (RMS) (Forward) OFF switch” on page 6-48.

📖 NOTE

- The RMS (Forward) ON/OFF is switched in conjunction with the ON/OFF state of the FCM-LS.

Rear-view camera*

If the indicator lamp comes on or blinks

E00651900024

If an abnormal condition occurs in the system, the FCM and Pre-collision Acceleration Control system operation indicator lamp and/or the FCM and Pre-collision Acceleration Control system OFF indicator lamp will come on or blink.

6

Have the vehicle inspected by an authorised MITSUBISHI MOTORS dealer as soon as possible.

Refer to “FCM and Pre-collision Acceleration Control system operation indicator lamp/FCM and Pre-collision Acceleration Control system OFF indicator lamp” on page 6-49.

Rear-view camera*

E00618402945

The rear-view camera is a system that shows the view behind the vehicle on a screen of the Smartphone-link Display Audio (SDA).

CAUTION

- The rear-view camera is an assistance system that enables the driver to check for obstacles behind the vehicle. Its range of view is limited, so you should not overly depend on it. Please drive just as carefully as you would if the vehicle did not have the rear-view camera.
- Be sure to visually confirm safety around the vehicle with your own eyes. Do not depend entirely on the rear-view camera.

Range of view of rear-view camera

The range of view of the rear-view camera is limited to the area shown in the illustrations. It cannot show the both sides and the lower part of the rear bumper, etc. When reversing, be sure to visually confirm safety around the vehicle.

Location of rear-view camera

The rear-view camera (A) is in the tailgate.

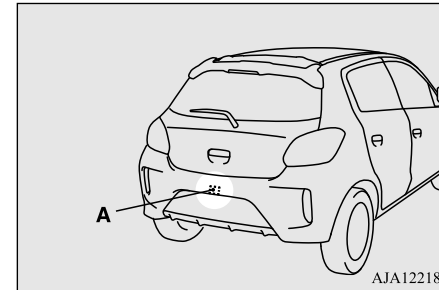

Range of view of rear-view camera

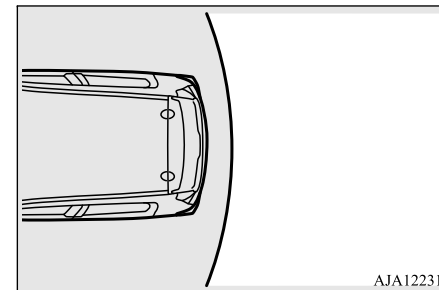

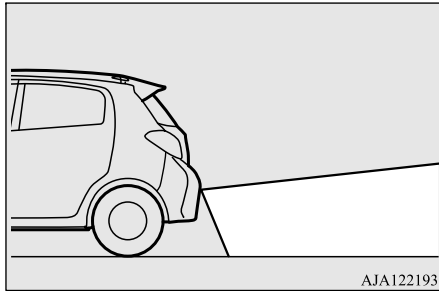

AJA122193

How to use the rear-view camera

When you place the gearshift lever or the selector lever in the “R” position with the ignition switch or the operation mode in ON, the view behind the vehicle will automatically appear on the screen of the Smartphone-link Display Audio (SDA). When you move the gearshift lever or the selector lever to any other position, the screen will return to its original indication.

CAUTION

- The rear-view camera has a special lens that can make objects shown on the screen appear to be closer or further away than they actually are.

NOTE

- Because the rear-view camera has a special lens, the lines on the ground between parking spaces may not look parallel on the screen.
- In the following situations, the screen indication may be difficult to see. There is no abnormality.
 - Low light (nighttime)
 - When the light of the sun or the light from a vehicle’s headlamps shines directly into the lens
- If the camera is hot and is then cooled by rain or a car wash, the lens can mist up. This phenomenon does not indicate a malfunction.
- It is not possible to fully see obstacles when the lens is dirty. If the lens becomes contaminated by water droplets, snow, mud, or oil, wipe off the contamination, taking care not to scratch the lens.
- Please observe the following cautions. Ignoring them could lead to a camera malfunction.
 - Do not subject the camera to physical shock.
 - Do not apply wax to the camera.
 - Do not splash the camera with boiling water.
 - Do not disassemble the camera.

Reference lines on the screen

Reference lines and upper surface of the rear bumper (A) are displayed on the screen.

- Red line (B) indicates approximately 50 cm behind the rear bumper.
- Two Green lines (C) indicate approximately 20 cm outside of the vehicle body.
- Short transverse lines (1 to 3) indicate distance from the rear bumper.

6

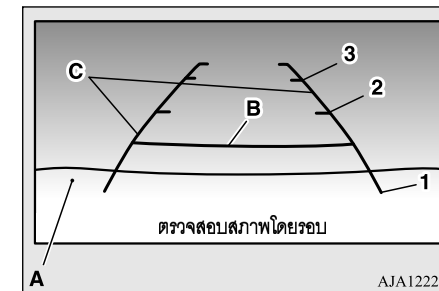

- 1: Approximately at the rear edge of the rear bumper
- 2: Approximately 100 cm
- 3: Approximately 200 cm

Rear-view camera*

6

NOTE

- When the vehicle is tilting because of the number of people in the vehicle, the weight and positioning of luggage, and/or the condition of the road surface, the lines in the view from the rear-view camera may not be accurately positioned relative to the actual road. The reference lines for distance and vehicle width are based on a level, flat road surface. In the following cases, objects shown on the screen will appear to be farther off than they actually are.
- When the rear of the vehicle is weighed down with the weight of passengers and luggage in the vehicle.

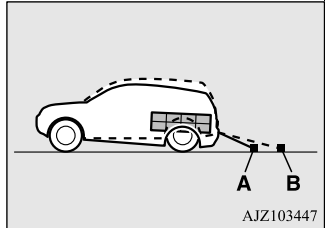

A: Actual objects
B: Objects shown on the screen

NOTE

- When there is an upward slope at the back.

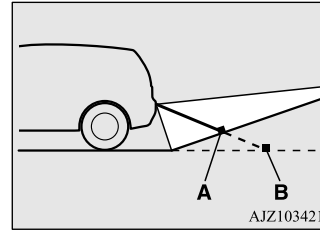

A: Actual objects
B: Objects shown on the screen

NOTE

- The reference lines for distance and vehicle width are intended to indicate the distance to a flat object such as a level, flat road surface. This may make the distance to a projecting object shown on the screen differ from the actual distance to the projecting object. Do not use them as a guide to distances to solid objects.
Example: On the screen the point B appears the nearest, then the point C and A in order of distance. The point A and B actually are the same distances from the vehicle, and the point C is farther off than the point A and B.

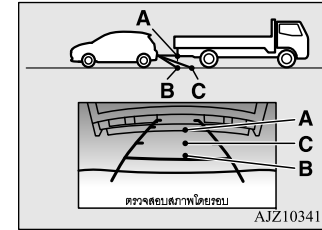

AJZ103418

Cargo loads

E00609901484

Cargo loads precautions

CAUTION

- Do not load cargo or luggage higher than the top of the seatback. Be sure that your cargo or luggage cannot move once your vehicle is moving.
Having the rear view blocked, and your cargo being thrown inside the cabin if you suddenly have to brake can cause a serious accident or injury.
- Load heavy cargo or luggage in the front of the vehicle. If the load in the back of the vehicle is too heavy, steering may become unstable.

Loading a roof carrier

CAUTION

- Use a roof carrier that properly fits your vehicle.
Do not load luggage directly onto the roof. For installation, refer to the instruction manual accompanying the roof carrier.

CAUTION

- When attaching/removing the roof carrier and loading/removing luggage, do not apply excessive pressure on a single point. Depending on how and where the force is applied, this may cause dents on the vehicle roof.

Roof carrier precaution

CAUTION

- Make sure that the weight of the luggage does not exceed the allowable roof load. If the allowable roof load is exceeded, this may cause damage to the vehicle. The roof load is the total allowable load on the roof (the weight of the roof carrier plus the weight of luggage placed on the roof carrier).
- When luggage is loaded onto the vehicle, please make sure to drive slowly and avoid excessive manoeuvres such as sudden braking or quick turning.
In addition, place the luggage on the carrier so that its weight is distributed evenly with the heaviest items on the bottom. Do not load items that are wider than the roof carrier. The additional weight on the roof could raise the vehicle's centre of gravity and affect vehicle handling characteristics. As a result, driving errors or emergency manoeuvres could lead to a loss of control and result in an accident.

CAUTION

- Before driving and after travelling a short distance, always check the load to make sure it is securely fastened to the roof carrier. Check periodically during your travel that the load remains secure.

NOTE

- To prevent wind noise or reduction in fuel economy, remove the roof carrier when not in use.
- Before using an automatic car wash, remove the roof carrier.
- Be sure that adequate clearance is maintained for raising the tailgate when installing a roof carrier.



For pleasant driving

Ventilators	7-2
Cooler*	7-3
Automatic air conditioning*	7-6
Important operation tips for the air conditioning	7-11
Air purifier	7-12
Antenna	7-12
Link System*	7-13
USB input terminal	7-13
Sun visors	7-14
Accessory socket	7-14
Interior lamps	7-15
Storage spaces	7-16
Cup holder	7-17
Bottle holder	7-18
Rear shelf panel	7-18
Convenient hook	7-19
Assist grip	7-19

Ventilators

Ventilators

E00700100979

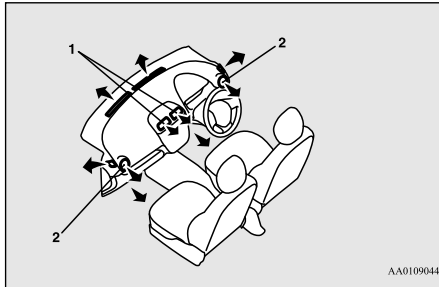

7

- 1- Centre ventilators
- 2- Side ventilators

NOTE

- Do not place beverages on top of the instrument panel. If they splash into the air conditioning ventilators, they could damage the system.

Air flow and direction adjustments

E00700202147

Centre ventilators

Move the knob (A) to make adjustments.

7-2 For pleasant driving

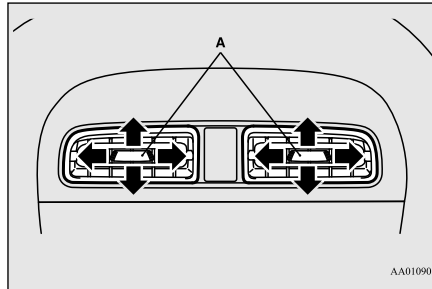

Side ventilators

When the dimple (A) is pressed, the ventilators open.
To close the ventilators, press the dimple on the opposite side.
Change the direction of the air flow by turning the ventilator itself.

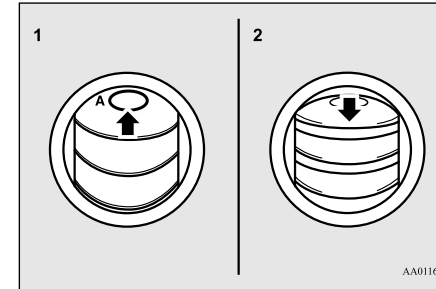

- 1- Open
- 2- Close

NOTE

- The cool air from the ventilators may appear as a mist.
This is due to moist air being suddenly cooled by the air conditioning. This will clear after a few moments.

Mode selection

E00726501949

To change the position and amount of air flowing from the ventilators, turn the mode selection dial.

On vehicles with the automatic air conditioning, press the MODE switch or demister switch. (Refer to “Mode switch” on page 7-10, “Demister switch” on page 7-10.)

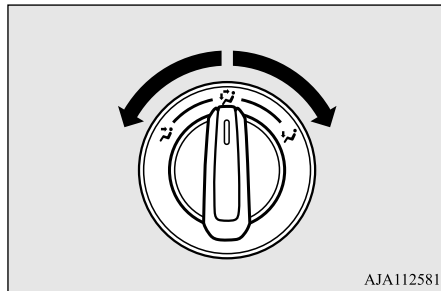

AJA112581

Face position

Air flows only to the upper part of the passenger compartment.

Foot/Face position

Air flows to the upper part of the passenger compartment, and flows to the leg area.

Foot position

Air flows mainly to the leg area.

Foot/Demister position*

Air flows to the leg area, the windscreen and the door windows.

Demister position*

Air flows mainly to the windscreen and the door windows.

NOTE

- The windows may start to fog up while the Auto Stop & Go (AS&G) system is operating. If this occurs, press the demister switch to remove fog from the windows.
- With the mode selection dial between the “” and “” positions, air flows mainly to the upper part of the passenger compartment. With the mode selection dial between the “” and “” positions, air flows mainly to the leg area.
- With the mode selection dial in the “” position, a small amount of air flows to the windscreen and the door windows.

Cooler*

E00700501752

The air conditioning can only be used while the engine is running.

CAUTION

- The engine speed may increase when the air conditioning is operating. With an increased engine speed, a CVT vehicle will creep to a greater degree than with a lower engine speed. Fully depress the brake pedal to prevent the vehicle from creeping.

7

Control panel

E00700601782

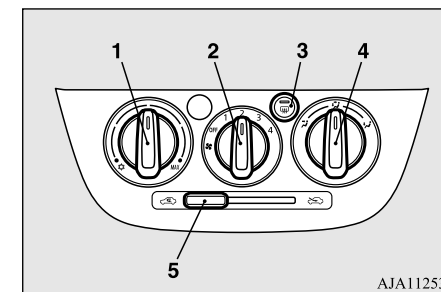

AJA112536

- 1- Cooler switch
- 2- Blower speed selection dial

Cooler*

- 3- Rear window demister switch
→ P.5-23
- 4- Mode selection dial
- 5- Air selection lever

Blower speed selection dial

E00700701334

Select the blower speed by turning the blower speed selection dial clockwise or anticlockwise.

7

The blower speed will gradually increase as the dial is turned to the right.

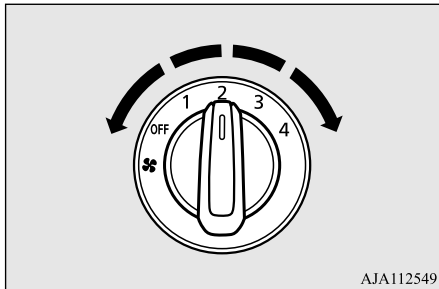

Temperature control dial/cooler switch

E00700901714

The temperature control dial is used to select the desired air temperature.

When the dial is turned clockwise from “●” position at “⚙️” side, the cooler automatically turns on.

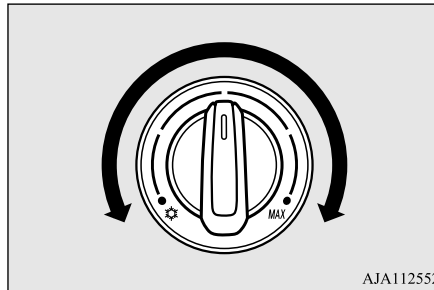

Air selection lever

E00701301832

To change the air selection, use the air selection lever.

- “🌬️” Outside air
Outside air is introduced into the passenger compartment.
- “🔄” Recirculated air
Air is recirculated inside the passenger compartment.

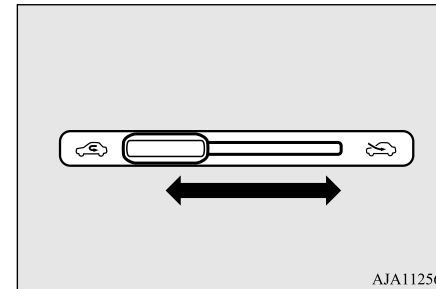

⚠️ CAUTION

- Use of the recirculation position for an extended time may cause the windows to fog up.

NOTE

- Normally, use the outside position to keep the windscreen and side windows clear and quickly remove fog or frost from the windscreen.
If high cooling performance is desired, or if the outside air is dusty or otherwise contaminated use the recirculation position. Switch to the outside position periodically to increase ventilation so that the windows do not become fogged up.

CAUTION

- If the outside air is dusty or otherwise contaminated, or if high cooling performance is desired, set air selection lever to the recirculation position and the temperature control dial all the way to the left.
Switch to the outside position periodically to increase ventilation so that the windows do not become fogged up.

7**Operating the cooler system**

E00701801589

Cooling

E00701902112

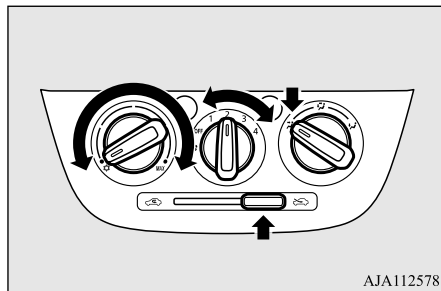

AJA112578

Automatic air conditioning*

Automatic air conditioning*

E00702401739

The air conditioning can only be used while the engine is running.

⚠ CAUTION

- The engine speed may increase when the air conditioning is operating.
With an increased engine speed, a CVT vehicle will creep to a greater degree than with a lower engine speed. Fully depress the brake pedal to prevent the vehicle from creeping.

7

Control panel

E00702502809

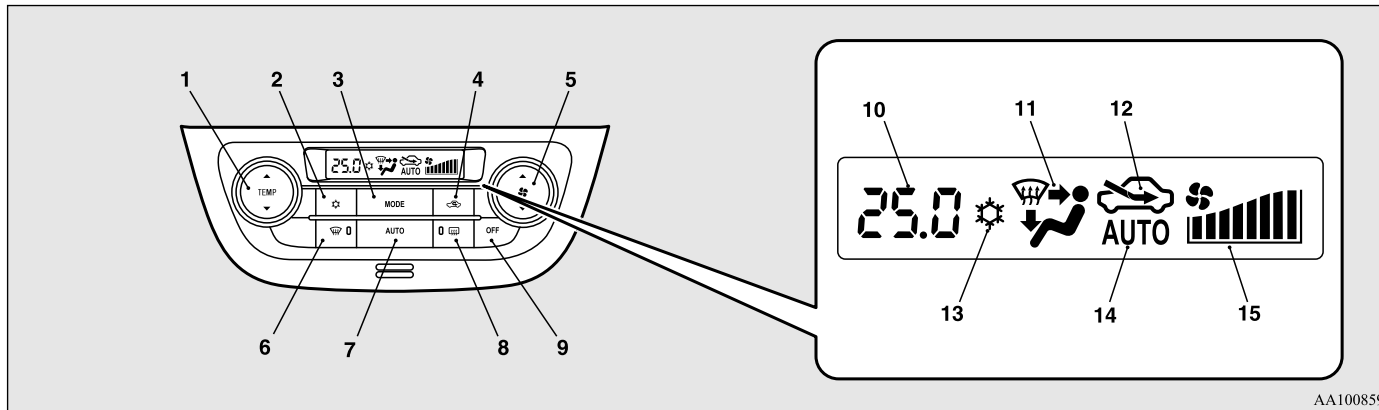

AA1008593

- 1- Temperature control switch
- 2- Air conditioning switch
- 3- MODE switch

- 4- Air selection switch
- 5- Blower speed selection switch
- 6- Demister switch

- 7- AUTO switch
- 8- Rear window demister switch
→ P.5-23

7-6 For pleasant driving

Automatic air conditioning*

- 9- OFF switch
- 10- Temperature display
- 11- Mode selection display
- 12- Air selection indicator
- 13- Air conditioning indicator
- 14- AUTO indicator
- 15- Blower speed display

The selected blower speed will be shown in the display (A).

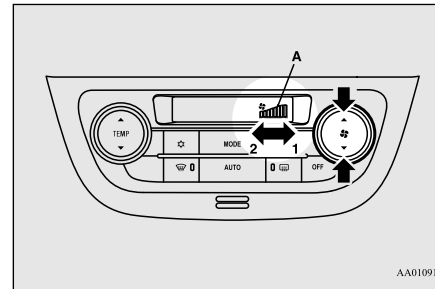

- 1- Increase
- 2- Decrease

Temperature control switch

E00703001820

Press ▲ or ▼ of the temperature control switch to the desired temperature. The selected temperature will be shown in the display (A).

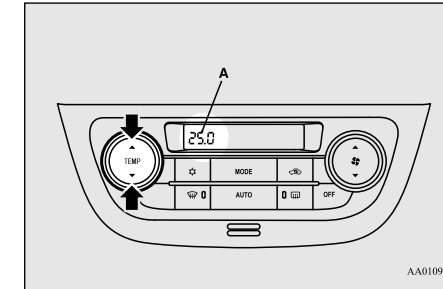

AA0109174

NOTE

- The temperature value of air conditioning is switched in conjunction with outside temperature display unit of the multi information display. Refer to “Changing the temperature unit” on page 5-10.
- While the engine coolant temperature is low, the temperature of the air from the heater will be cool/cold until the engine warms up, even if you have selected warm air with the switch. To prevent the windscreen and windows from fogging up, the ventilator mode will be changed to “” and the blower speed will be reduced.
- When the temperature is set to the highest or the lowest, the air selection and the air conditioning will be automatically changed as follows.

NOTE

- There is an interior air temperature sensor (A) in the illustrated position. Never place anything on top of the sensor, since doing so will prevent it from functioning properly.

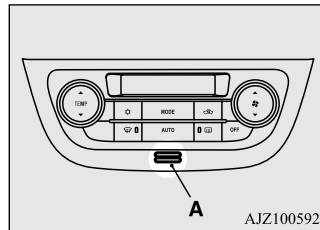

AJZ100592

- A sound will be made every time you push all the switches.

Blower speed selection switch

E00702800358

Press ▲ of the blower speed selection switch to increase the blower speed.

Press ▼ of the blower speed selection switch to decrease the blower speed.

Automatic air conditioning*

NOTE

- Quick Heating (When the temperature is set to the highest setting)
Outside air will be introduced and the air conditioning will stop.
- Quick Cooling (When the temperature is set to the lowest setting)
Inside air will be recirculated and the air conditioning will operate.

7

The settings described above are the factory settings.

The air selection and air conditioning switches can be customised (function setting changed), and the automatic switching of outside air and the air conditioning according to operating conditions can be changed as desired.

For further information, please consult an authorised MITSUBISHI MOTORS dealer.

Refer to “Customising the air conditioning switch” on page 7-9.

Refer to “Customising the air selection” on page 7-8.



Air selection switch

E00703401811

To change the air selection, simply press the air selection switch.

The selected position will be shown in the display (A).

7-8 For pleasant driving

- Outside air: “” indicator is ON
Outside air is introduced into the passenger compartment.
- Recirculated air: “” indicator is ON
Air is recirculated inside the passenger compartment.

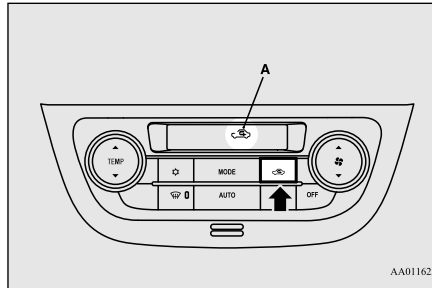

CAUTION

- Use of the recirculation position for extended time may cause the windows to fog up.

NOTE



- Normally, use the outside position to keep the windscreen and side windows clear and quickly remove fog or frost from the windscreen.
If high cooling performance is desired, or if the outside air is dusty or otherwise contaminated use the recirculation position.
Switch to the outside position periodically to increase ventilation so that the windows do not become fogged up.
- If you press the AUTO switch to select automatic control after manually switching between outside air and recirculated air, the air selection will also be automatically controlled.

■ Customising the air selection

Functions can be changed as desired, as stated below.

- Enable automatic air control
When the AUTO switch pressed, the air selection switch is also controlled automatically.
- Disable automatic air control
Even when the AUTO switch is pressed, the air selection switch is not controlled automatically.
- Setting change method

Hold down the air selection switch for about 10 seconds or more.

- When the setting is changed from enable to disable 3 sounds are emitted and the “” indicator flashes 3 times.
- When the setting is changed from disable to enable 2 sounds are emitted and the “” indicator flashes 3 times.

NOTE

- The factory setting is “Enable automatic air control”.
- When the demister switch is pressed, in order to prevent misting of the windows the ventilator automatically switches to outside air even if “Disable automatic air control” is set.

AUTO switch

E00702600040

When the AUTO switch is pressed, the mode selection, blower speed adjustment, recirculated/outside air selection, temperature adjustment, and air conditioner ON/OFF status are all controlled automatically.

The “AUTO” indicator will be shown in the display (A).

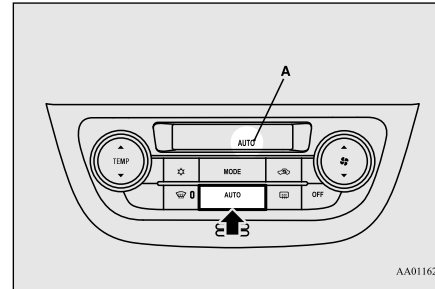

AA0116293

Air conditioning switch

E00703502659

Push the switch to turn the air conditioning on, the “” indicator will be shown in the display (A).

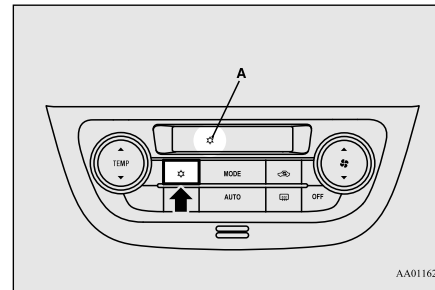

AA0116235



Push the switch again to switch it off.

■ Customising the air conditioning switch

Functions can be changed as desired, as stated below.

- Enable automatic air conditioning control: When the AUTO switch is pressed, or the temperature control switch is set to the minimum temperature, the air conditioning switch is controlled automatically.
- Disable automatic air conditioning control:

The air conditioning switch is not controlled automatically as long as the air conditioning switch is not operated.

- Setting change method: Hold down the air conditioning switch for about 10 seconds or more.
 - When the setting is changed from enable to disable: 3 sounds are emitted and the “” indicator flashes 3 times.
 - When the setting is changed from disable to enable: 2 sounds are emitted and the “” indicator flashes 3 times.

7

NOTE

- The factory setting is “Enable automatic air conditioning control”.

Automatic air conditioning*

NOTE

- When the demister switch is pressed, in order to prevent misting of the windows the air conditioning operates automatically even if “Disable automatic air conditioning control” is set.

OFF switch

E00702700041

Push the switch to turn off the air conditioning system.



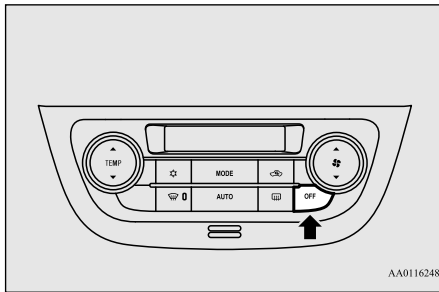

7



AA0116248

MODE switch

E00703300044

Each time the MODE switch is pressed, the mode changes to the next one in the following sequence: “” → “” → “” → “” → “”. The selected mode is shown in the display (A). (Refer to “Mode selection”

7-10 For pleasant driving

on page 7-2.)

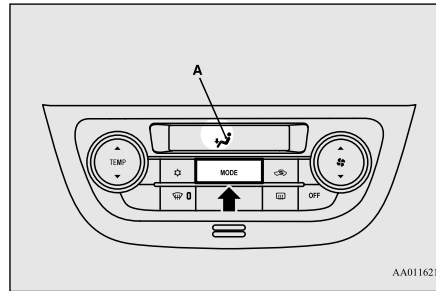

AA0116219

Demister switch

E00703900066

When this switch is pressed, the mode changes to the “” mode. The indicator lamp (A) will come on. The selected mode is shown in the display (B). (Refer to “Mode selection” on page 7-2.)

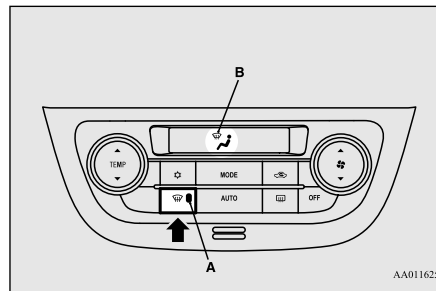

AA0116251

NOTE

- When the demister switch is pressed, the air conditioning system automatically operates and outside air (as opposed to recirculated air) is selected. (Refer to “Demisting of the windscreen and door windows” on page 7-11.)

Operating the system in automatic mode

E00704102607

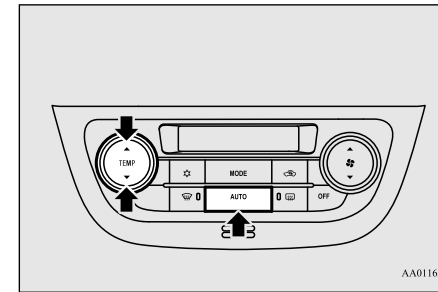

AA0116264

In normal conditions, use the system in the AUTO mode and follow these procedures:

1. Push the AUTO switch.
2. Set the temperature control switch to the desired temperature.

Important operation tips for the air conditioning

The mode selection, blower speed adjustment, recirculated/outside air selection, temperature adjustment, and air conditioner ON/OFF status are all controlled automatically.

NOTE

- If the blower speed selection switch, air conditioning switch, Mode switch, or air selection switch is operated while the system is operating in the AUTO mode, the activated function overrides the corresponding function of automatic control. All other functions remain under automatic control.

Operating the system in manual mode

E00704200239

Blower speed and ventilator mode may be controlled manually by setting the blower speed selection switch and the MODE switch to the desired positions.

To return to automatic operation, press the AUTO switch.

Demisting of the windscreen and door windows

E00704300894

CAUTION

- For safety, make sure you have a clear view through all the windows.

For ordinary demisting

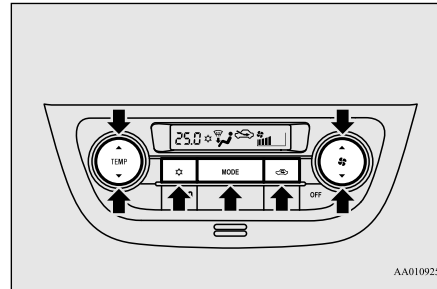

1. Set the air selection switch to the outside position.
2. Set the MODE switch to the “windshield” position.
3. Select your desired blower speed by pressing the blower speed selection switch.
4. Select your desired temperature by pressing the temperature control switch.
5. Push the air conditioning switch.

For quick demisting

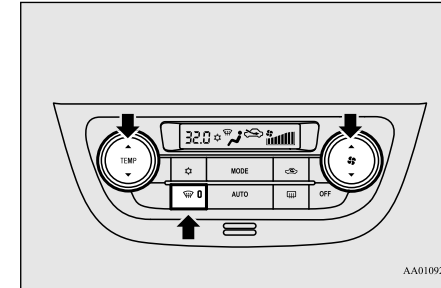

1. Push the demister switch to change to the “windshield” position.
2. Set the blower to the maximum speed.
3. Set the temperature to the highest position.

NOTE

- To demist effectively, direct the air flow from the side ventilators towards the door windows.
- Do not set the temperature to the max. cool position. Cool air will blow against the window glasses and prevent demisting.

Important operation tips for the air conditioning

E00708301059

- Park the vehicle in the shade.

7

Air purifier

7

Parking in the hot sun will make the vehicle inside extremely hot, and it will require more time to cool the interior.

If it is necessary to park in the sun, open the windows for the first few minutes of air conditioning operation to expel the hot air.

- Close the windows when the air conditioning is in use. The entry of outside air through open windows will reduce the cooling efficiency.
- Too much cooling is not good for the health. The inside air temperature should only be 5 to 6 °C below the outside air temperature.
- When operating the system, make sure the air intake, which is located in front of the windscreen, is free of obstructions such as leaves and snow. Leaves collected in the air-intake plenum may reduce air flow and plug the plenum water drains.

Air conditioning system refrigerant and lubricant recommendations

If the air conditioning seems less effective than usual, the cause might be a refrigerant leak. Have the system inspected by your authorised MITSUBISHI MOTORS dealer.

The air conditioning system in your vehicle must be charged with the refrigerant HFC-134a and the lubricant ZXL 200PG.

Use of any other refrigerant or lubricant will cause severe damage which will result in the need to replace your vehicle's entire air conditioning system. The release of refrigerant into the atmosphere should be prevented. It is recommended that the refrigerant be recovered and recycled for further use.

During a long period of disuse

The air conditioning should be operated for at least five minutes each week, even in cold weather. This is to prevent the compressor from seizing and to maintain the air conditioning in the best operating condition.

Air purifier

An air filter has been incorporated into this air conditioning so that dirt and dust are cleaned from the air.

Replace the air filter periodically as its ability to clean the air will be reduced as it collects pollen and dirt. For the maintenance interval, refer to the "SERVICE BOOKLET".

NOTE

- Operation in certain conditions such as driving on a dusty road and frequent use of the air conditioning can lead to reduction of service life of the filter. When you feel that the airflow is lower than normal or when the windscreen or windows start to fog up easily, replace the air filter.
Contact an authorised MITSUBISHI MOTORS dealer for assistance.

Antenna

E00710501726

To remove

Turn the pole (A) anticlockwise.

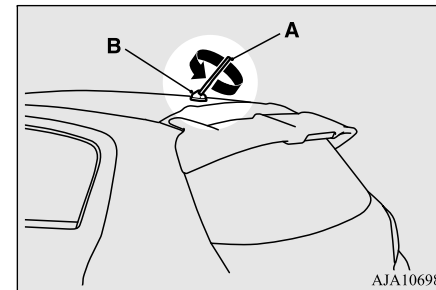

To install

Screw the pole (A) clockwise into the base (B) until it is securely retained.

NOTE

- Be sure to remove the roof antenna in the following cases:
 - When going into an automatic car wash.
 - When placing a car cover over the vehicle.
 - When driving into a structure that has a low ceiling.

Link System*

E00764501888

The Link System takes overall control of the devices connected via the USB input terminal allowing the connected devices to be operated by using the switches in the vehicle.

Refer to “USB input terminal” on page 7-13 and separate owner’s manual for Smartphone Link Display Audio to play the USB devices.

USB input terminal

E00761902080

You can connect your USB memory device or iPod* to play music files stored in the USB memory device or iPod.

*: “iPod” is a registered trademark of Apple Inc. in the United States and other countries.

This section explains how to connect and remove a USB memory device or iPod. Refer to the separate owner’s manual for details on the types of connectable devices and supported files, and how to play music files.

WARNING

- **Do not perform to connect/disconnect the USB memory device or iPod while driving. This can be dangerous. Be sure to perform before driving.**

NOTE

- Connect the USB device after starting the engine. The USB memory device may become damaged if it is already connected when the ignition is turned on.

How to connect a USB memory device

E00762002062

1. Connect a commercially available USB connector cable (A) to the USB memory device (B).

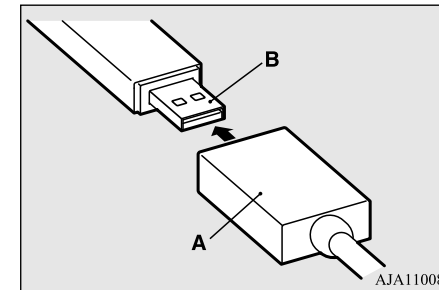

2. Open the cover (C) and connect the opposite end of the USB connector cable.

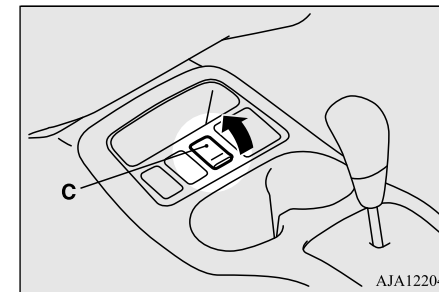

7

Sun visors

NOTE

- Do not connect the USB memory device to the vehicle's connector directly. The USB memory device may be damaged.

How to connect an iPod

E00762102122

1. Connect the connector cable to the iPod.

7

NOTE

- Use a genuine connector cable from Apple Inc.

2. Open the cover (A) and connect the opposite end of the connector cable.

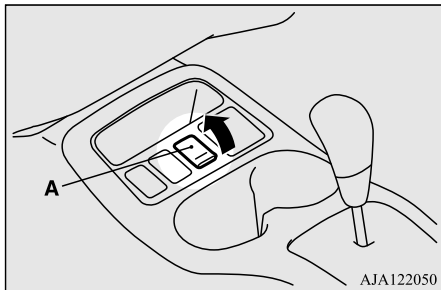

Sun visors

E00711202815

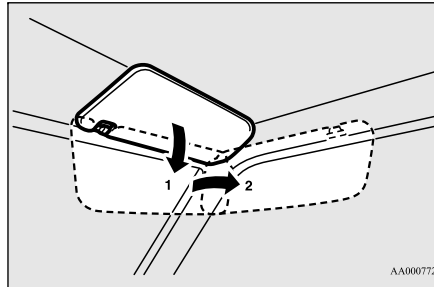

- 1- To eliminate front glare
- 2- To eliminate side glare

Vanity mirror

A vanity mirror is fitted to the back of the sun visor.

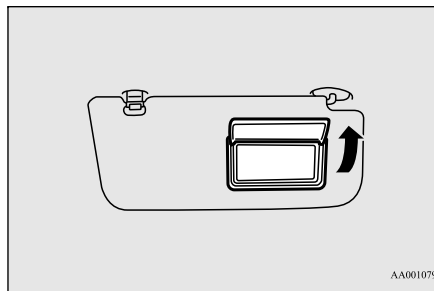

Ticket holder

The holder (A) is located on the back of the sun visor.

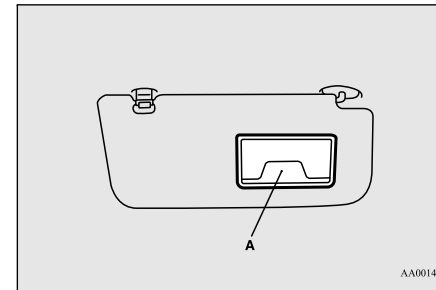

CAUTION

- Do not leave plastic cards in the ticket holder. Because the inside of the vehicle will become hot if the vehicle is parked in strong sunlight, the cards could deform or crack.

Accessory socket

E00711602721

The accessory socket can be used while the ignition switch or the operation mode is in ON or ACC.

To use a plug-in type accessory, open the cap, and insert the plug in the accessory socket.

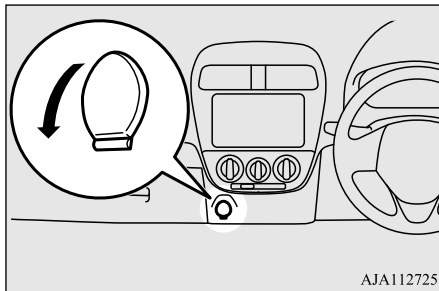

AJA112725

CAUTION

- Be sure to use a “plug-in” type accessory operating at 12 V and at 120 W or less.
- Long use of the electric appliance without running the engine may run down the battery.
- When the accessory socket is not in use, be sure to close the cap, because the socket might become clogged by foreign material and be short-circuited.

Interior lamps

E00712002621

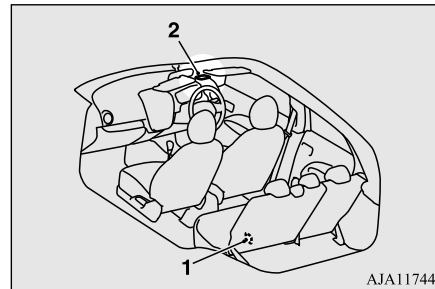

AJA117443

- 1- Luggage room lamp
- 2- Room lamp

NOTE

- If you leave the lamp on without running the engine, you will run down the battery. Before you leave the vehicle, make sure that the lamp is off.

Room lamp

E00712601558

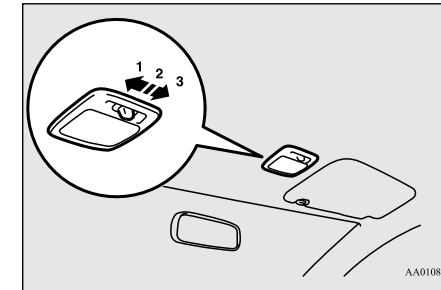

AA0108656

7

1- (☒)

The lamp illuminates regardless of whether a door or the tailgate is open or closed.

2- (•)

Delayed off function

The lamp illuminates when a door or the tailgate is opened. It goes off about 15 seconds after the door or tailgate is closed.

However, the lamp goes off immediately with all doors and the tailgate closed in the following cases:

- When the ignition switch is turned to the “ON” position or the operation mode is put in ON.
- When the central door lock function is used to lock the vehicle.

Storage spaces

7

- When the keyless entry key or the keyless operation key is used to lock the vehicle.
- If the vehicle is equipped with the keyless operation system, when the keyless operation function is used to lock the vehicle.

Auto cut-out function

If the lamp is left switched on with the ignition switch is in the “LOCK” or “ACC” position or the operation mode is in OFF or ACC, and a door or the tailgate is opened, it goes off automatically after approximately 30 minutes.

The lamp will illuminate again after it automatically goes off in the following cases:

- When the ignition switch is turned to the “ON” position or the operation mode is put in ON.
- When the keyless entry system or the keyless operation system is operated.
- When all doors and the tailgate are closed.

NOTE

- When the key was used to start the engine, if the key is removed while the doors and tailgate are closed, the lamp is illuminated and after a few seconds it goes off.

NOTE

- When the keyless operation function was used to start the engine, if the operation mode is put in OFF while the doors and tailgate are closed, the lamp illuminates and after about 15 seconds it goes off. (if so equipped)
- The time until the lamp goes off (delayed off) can be adjusted. Please consult an authorised MITSUBISHI MOTORS dealer.
- The auto cut-out function cannot be operated when the room lamp switch is in the “” position. Also, this function can be deactivated. For details, please consult an authorised MITSUBISHI MOTORS dealer.

3- (○)

The lamp goes off regardless of whether a door or the tailgate is open or closed.

Luggage room lamp

E00712701849

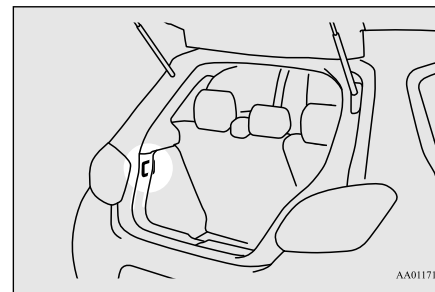

The lamp illuminates when the tailgate is opened, and goes out when the tailgate is closed.

Storage spaces

E00713101895

CAUTION

- Never leave lighters, canned carbonated beverage, and spectacles in the cabin when parking the vehicle in hot sunshine. The cabin will become extremely hot, so lighters and other flammable items may catch fire and unopened drink cans may rupture. Also, spectacles with plastic lenses or materials could deform or crack.
- Keep the lids on storage spaces closed while driving the vehicle. A lid or the contents of a storage space could otherwise cause injuries.

Glove box

E00717603036

To open, pull the lever (A).

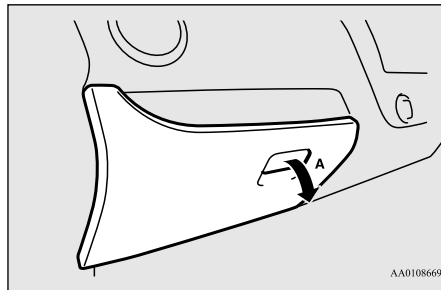

Luggage floor box

E00718701896

The box (A) for storing articles is located inside the luggage compartment. To use the box, raise the luggage floor board (B).

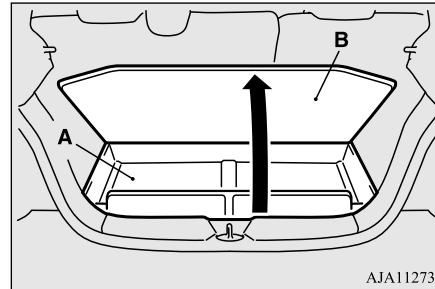

Cup holder

E00714502428

⚠ WARNING

- Do not spray water or spill beverages inside the vehicle. If the switches, wires, or electrical components become wet, they could malfunction or cause a vehicle fire. If you accidentally spill a beverage, wipe up as much liquid as possible and immediately consult an authorised MITSUBISHI MOTORS dealer.

⚠ CAUTION

- Do not drink beverages while driving. This is distracting and could cause an accident.

📖 NOTE

- Plastic bottles may sometimes not fit securely depending on the shape of the bottle. Plastic bottles could fall if driving is done while a plastic bottle is not securely placed, so check that plastic bottles are placed securely or use the bottle holder.

For the front seat

The cup holder is located in front of the floor console.

7

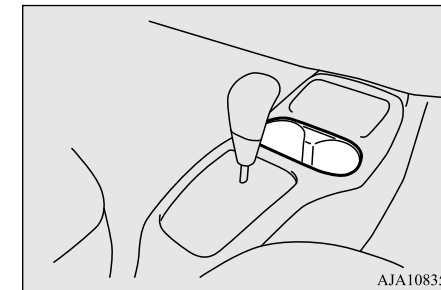

For the rear seat

E00718900152

The cup holder is located behind the parking brake lever.

Bottle holder

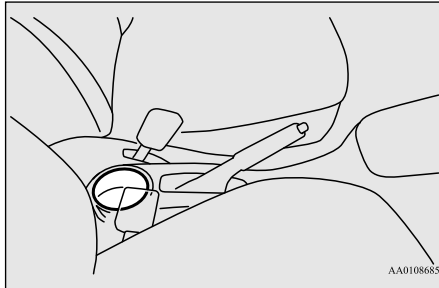

7

Bottle holder

E00718201758

⚠ WARNING

- Do not spray water or spill beverages inside the vehicle. If the switches, wires, or electrical components become wet, they could malfunction or cause a vehicle fire. If you accidentally spill a beverage, wipe up as much liquid as possible and immediately consult an authorised MITSUBISHI MOTORS dealer.

⚠ CAUTION

- Do not drink beverages while driving. This is distracting and could cause an accident.
- Drinks could be spilled by the vibration and jolts while driving. If the spilt drink is very hot, you could be burnt.

There are bottle holders located on the front doors.

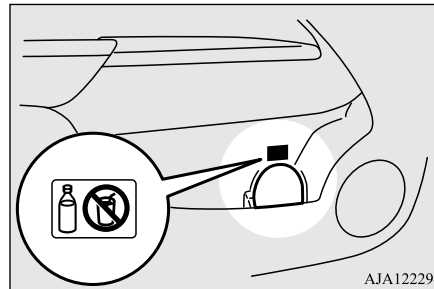

NOTE

- Do not store cup or drink can in the bottle holder.
- Tightly close the cap on drink bottles before storing them.
- Some bottles may be too big or the wrong shape to fit in the holder.

Rear shelf panel

E00715401254

⚠ CAUTION

- Do not place luggage or other items on the rear shelf panel. Any items on the rear shelf panel would obstruct your rearward view, and they could fly forward and cause injuries or other mishap in the event of hard braking.

To install

1. Insert the concave portion (A) on the underside of the rear shelf panel into the inside protruding portion (B) of the rear pillar.

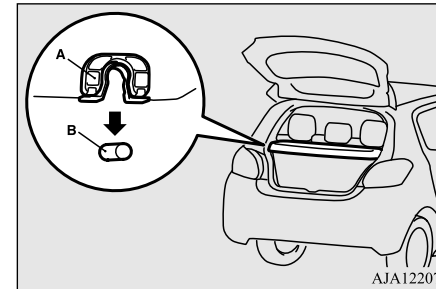

⚠ CAUTION

- Lightly push the rear shelf panel to make sure that the concave portion (A) is set firmly in the protruding portion (B) of the tailgate. If the rear shelf panel is not securely locked in place, it could unhook while driving and cause injuries.

2. Hang the strap (C) of the rear shelf panel on the hook (D).

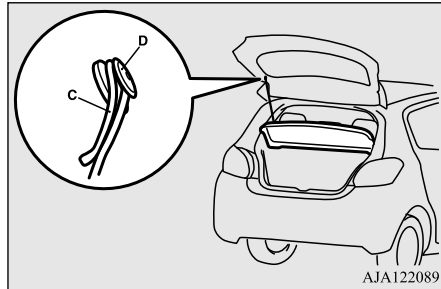

AJA122089

To remove

Follow this procedure in reverse to remove.

Convenient hook

E00732901443

Light items of luggage can be hung from the hook.

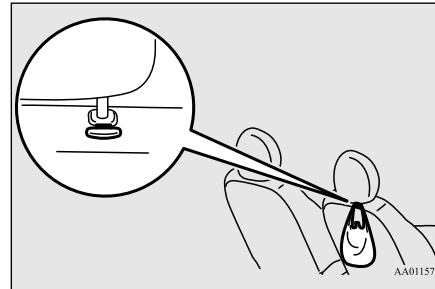

AA0115720

NOTE

- Do not hang heavy luggage (more than about 4 kg) on the hook. Doing so could cause damage to the hook.

Assist grip

E00732801527

The grip is to support the body by hand while seated in the vehicle.

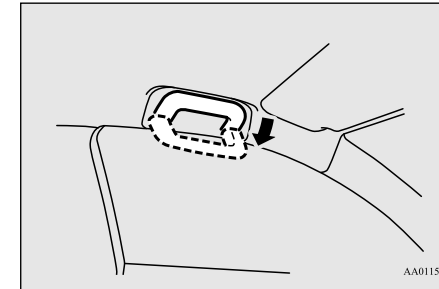

AA0115153

CAUTION

- Do not use the assist grip when getting into or out of the vehicle. The assist grip could detach causing you to fall.



For emergencies

If the vehicle breaks down	8-2
If the operation mode cannot be changed to OFF (vehicles equipped with the keyless operation system)	8-2
Emergency starting	8-2
Engine overheating	8-4
Tools and jack	8-5
Tyre repair kit	8-6
How to change a tyre	8-12
Towing	8-17
Operation under adverse driving conditions	8-20

If the vehicle breaks down

If the vehicle breaks down

E00800101137

If the vehicle breaks down on the road, move it to the shoulder and use the hazard warning flashers and/or the warning triangle etc. Refer to “Hazard warning flasher switch” on page 5-20.

If the engine stops/fails

8

Vehicle operation and control are affected if the engine stops. Before moving the vehicle to a safe area, be aware of the following:

- The brake booster becomes inoperative and the pedal effort will increase. Press down the brake pedal harder than usual.
- Since the power steering system is no longer operative, the steering wheel feels heavy when turning it.

If the operation mode cannot be changed to OFF (vehicles equipped with the keyless operation system)

E00804900208

If the operation mode cannot be changed to OFF, perform the following procedure.

1. Move the selector lever to the “P” (PARK) position, and then change the operation mode to OFF (for vehicles with CVT).
2. One of the other causes could be low battery voltage. If this occurs, the keyless entry system, keyless operation function, and steering wheel lock will also not operate. Contact an authorised MITSUBISHI MOTORS dealer.

Emergency starting

E00800504813

If the engine cannot be started because the battery is weak or dead, the battery from another vehicle can be used with jumper cables to start the engine.

WARNING

- To start the engine by use of jumper cables from another vehicle, perform the correct procedures according to the instruction below. Incorrect procedures could result in a fire or explosion or damage to the vehicles.
- Keep sparks, cigarettes and flames away from the battery because the battery may produce an explosion.

CAUTION

- Do not attempt to start the engine by pulling or pushing the vehicle. It could damage your vehicle.
- Check the other vehicle. It must have a 12-volt battery. If the other system isn't 12-volt, shorting can damage both vehicles.
- Use the proper cables suitable for the battery size to prevent overheating of the cables.
- Check the jumper cables for damage and corrosion before use.
- Always wear protective eye goggles when working near the battery.
- Keep the battery out of the reach of children.

1. Get the vehicles close enough so the jumper cables can reach, but be sure the vehicles aren't touching each other.
2. Turn off all lamps, heater and other electrical loads.
3. Set the parking brake firmly on each vehicle. Put an A/T or CVT in “P” (PARK) or a M/T in “N” (Neutral). Stop the engine.

WARNING

- Turn off the ignition on both vehicles beforehand. Make sure that the cables or your clothes cannot be caught by the fan or drive belt. Personal injury could result.

Emergency starting

4. Make sure battery electrolyte is at the proper level.

Refer to “Battery” on page 10-8.

⚠ WARNING

- If electrolyte fluid is not visible, or appears to be frozen, Do Not Attempt Jump Starting!

A battery might rupture or explode if the temperature is below the freezing point or if it is not filled to the proper level.

- Electrolyte is corrosive diluted sulphuric acid.

If electrolyte (battery acid) comes into contact with your hands, eyes, clothes or the painted surface of your vehicle, it should be thoroughly flushed with water. If electrolyte gets in your eyes, flush them with water immediately and thoroughly, and get prompt medical attention.

5. Connect one end of one jumper cable ① to the positive (+) terminal of the discharged battery (A), and the other end ② to the positive (+) terminal of the booster battery (B).

Connect one end of the other jumper cable ③ to the negative (-) terminal of the booster battery, and the other end ④ to the designated ground location of the vehicle with the discharged battery at the point farthest from the battery.

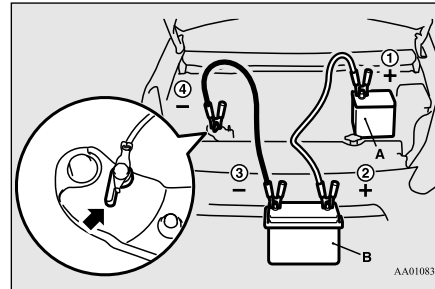

⚠ WARNING

- Make sure that the connection ④ is made to the appointed position (shown in the illustration). If the connection is made directly to the negative side of the battery, the inflammable gases generated from the battery might catch fire and explode.
- When connecting the jumper cable, do not connect the positive (+) cable to the negative (-) terminal. Otherwise sparks might cause explosion of the battery.

⚠ CAUTION

- Use care not to get the jumper cable caught in the cooling fan or other rotating part in the engine compartment.

6. Start the engine in the vehicle which has the booster battery, let the engine idle a few minutes, then start the engine in the vehicle with the discharged battery.

⚠ CAUTION

- Keep the engine of the vehicle giving assistance running.

📖 NOTE

- Press the “Auto Stop & Go (AS&G) OFF” switch to deactivate the Auto Stop & Go (AS&G) system and prevent the engine from automatically stopping before the battery is sufficiently charged. Refer to “To deactivate” on page 6-24.

7. After the engine is started, disconnect the cables in the reverse order and keep the engine running for several minutes.

📖 NOTE

- If the vehicle is put in motion without fully charging the battery, it might cause the loss of smooth engine operation and the anti-lock brake warning lamp to illuminate. Refer to “Anti-lock brake system (ABS)” on page 6-33.

Engine overheating

Engine overheating

E00800604511

If the high coolant temperature warning lamp illuminates during the engine is running, the engine may be overheating.

If this occurs, take the following corrective measures:

1. Stop the vehicle in a safe place.
2. Check whether steam is coming from the engine compartment.

8

[If steam does not come from the engine compartment]

With the engine still running, raise the bonnet to ventilate the engine compartment.

NOTE

- Press the “Auto Stop & Go (AS&G) OFF” switch to deactivate the Auto Stop & Go (AS&G) system before stopping the vehicle. Refer to “To deactivate” on page 6-24.

[If steam is coming from the engine compartment]

Stop the engine, and when the steam stops, raise the bonnet to ventilate the engine compartment. Restart the engine.

8-4 For emergencies

WARNING

- Do not open the bonnet while steam is coming from the engine compartment. It could cause steam or hot water to spurt out, causing burns. Hot water could spurt out even when there is no steam coming out, and some parts will be very hot. Be very careful when opening the bonnet.
- Be careful of hot steam, which could be blowing off the reserve tank cap.
- Do not attempt to remove the radiator cap while the engine is hot.

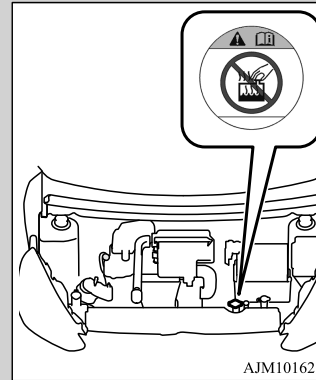

3. Confirm that the cooling fan (A) is turning.

[If the cooling fan is turning]

After the high coolant temperature warning lamp has gone off, stop the engine.

[If the cooling fan is not turning]

Stop the engine immediately and contact an authorised MITSUBISHI MOTORS dealer for assistance.

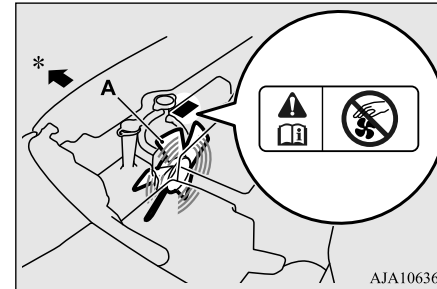

*: Front of the vehicle

WARNING

- Be careful not to get your hands or clothes caught in the cooling fan.

4. Check the coolant level in the reserve tank (B).
Add coolant to the radiator and/or reserve tank if necessary. (Refer to the “Maintenance” section.)

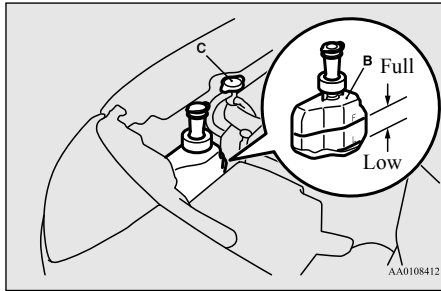

⚠ WARNING

- If there is none, make sure that the engine has cooled down before removing the radiator cap (C), because hot steam or boiling water otherwise will gush from the filler port and may scald you.

⚠ CAUTION

- Do not add coolant while the engine is hot. Suddenly adding cold coolant could damage the engine. Wait for the engine to cool down, then add coolant a little at a time.

5. Examine the radiator hoses for coolant leakage and the drive belt for looseness or damage.
If there is anything wrong with the cooling system or drive belt, have the problem corrected at an authorised MITSUBISHI MOTORS dealer.

Tools and jack

E00800903025

Storage

The tools are stored beneath the luggage floor box of the luggage compartment.
The jack is stored under the front passenger seat.
The storage location of the tools and jack should be remembered in case of an emergency.

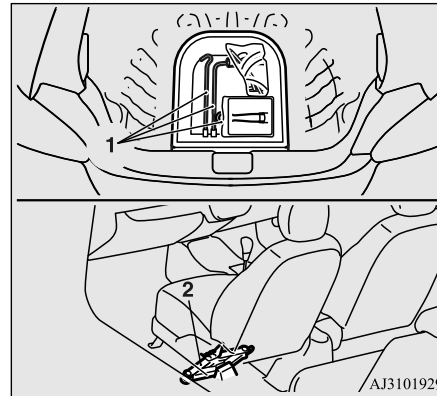

1- Tools

2- Jack

Tools

E00801902269

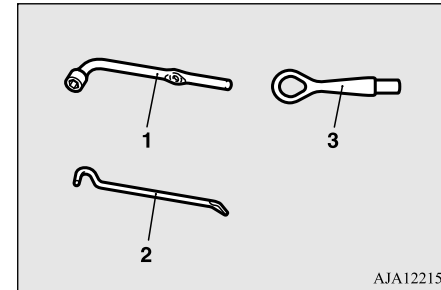

- 1- Wheel nut wrench
- 2- Jack bar
- 3- Towing hook

AJA122151

8

Jack

E00802001840

Before removing or storing the jack, move the front passenger seat fully forward to access the jack from the rear seat area. (Refer to “Front seat” on page 4-2.)

⚠ CAUTION

- Never access, remove or store the jack from the front of the seat. Doing so could damage electrical wires under the seat.

Tyre repair kit

To remove

Turn the shaft end of the jack in the direction (1) until the jack fully retracts and remove the jack from the holder (A).

To store

Put the jack in the holder (A) and turn the shaft end of the jack in the direction (2) by hand until the jack is firmly secured.

8

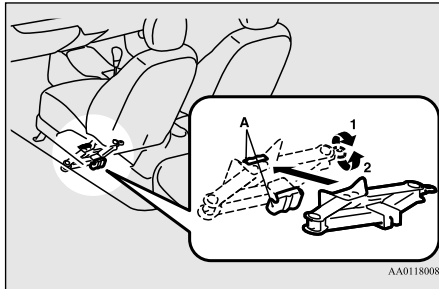

⚠ WARNING

- After storing the jack in place, make sure the jack is securely fixed in the holder. If the jack is not fixed securely, it may move and hit an occupant in an accident resulting in serious injury or death.

Tyre repair kit

E00804501243

This kit enables emergency repair of a small puncture in the tread area of a tyre that has run over a nail, screw, or similar object.

Storage

The tyre repair kit is stored beneath the luggage floor board of the luggage compartment. The storage location of the tyre repair kit should be remembered in case of an emergency.

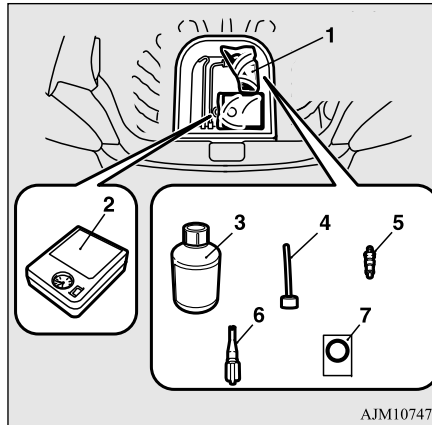

- 1- Tyre repair set
- 2- Tyre compressor

- 3- Tyre sealant bottle
- 4- Filler hose
- 5- Valve insert (spare)
- 6- Valve remover
- 7- Speed restriction sticker

How to use the tyre repair kit

E00804601257

⚠ WARNING

- Using the tyre repair kit may damage the wheel. The vehicle must promptly be inspected and repaired by an authorised MITSUBISHI MOTORS dealer after using the tyre repair kit.

⚠ CAUTION

- The tyre sealant can cause health damage if swallowed. If you accidentally swallow it, drink as much water as possible and immediately have yourself examined by a doctor.
- If the tyre sealant gets in your eyes or on your skin, rinse it away with lots of water. If you still sense an abnormality, have yourself examined by a doctor.
- Consult a doctor immediately if any allergic reactions occur.
- Be careful not to allow children to touch the tyre sealant.
- Do not breathe in the vapours of tyre sealant.

CAUTION

- Be sure to use a MITSUBISHI MOTORS GENUINE tyre sealant.

NOTE

- The tyre sealant cannot be used in any of the situations listed below. If any of these situations occurs, please contact an authorised MITSUBISHI MOTORS dealer or another specialist.
- The tyre sealant's expiry date has passed. (The expiry date is shown on the bottle label.)



AJZ101586

- More than one tyre is punctured.
- The puncture hole has a length or width of 4 mm or more.

NOTE

- The tyre is punctured in the side wall (A), not in the tread (B).

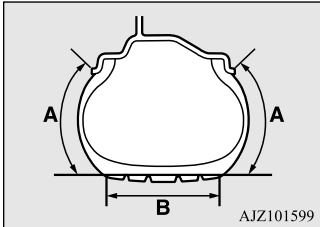

AJZ101599

- The vehicle has been driven with the tyre almost completely flat.
- The tyre has completely slipped over the wheel rim and come off the wheel.
- The wheel is damaged.
- Use the tyre sealant only at ambient temperatures of -30 °C to +60 °C.
- Effect an emergency repair without pulling out the object (nail, screw, etc.) that is stuck in the tyre.
- Do not use the tyre sealant if the tyre has been damaged by being driven when insufficiently inflated (e.g. bumps, cuts, cracks etc. on the tyre).
- Wipe tyre sealant off the paintwork immediately with a damp cloth.
- Immediately wash clothes contaminated with tyre sealant.
- Check the tyre sealant's expiry date regularly, and be sure to purchase a new one from an authorised MITSUBISHI MOTORS dealer before the expiry date.

Before repairing a tyre, first stop your vehicle in a safe, flat location.

1. Park the vehicle on level and stable ground.
2. Set the parking brake firmly.
3. Move the selector lever to the "P" (PARK) position and stop the engine.
4. Turn on the hazard flashers and set up a warning triangle, flashing signal lamp, etc., at an adequate distance from the vehicle, and have all your passengers leave the vehicle.
5. Take out the tyre repair kit.
6. Take the valve cap (C) off the tyre valve (D), then press the valve remover (E) onto the valve as illustrated. Allow all of the air in the tyre to escape.

8

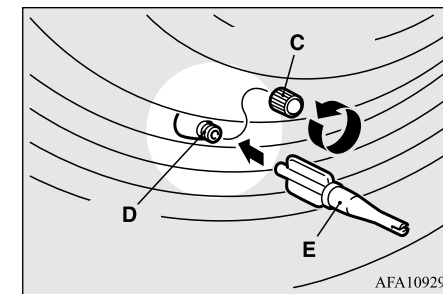

Tyre repair kit

7. Remove the valve insert (F) by turning it anticlockwise using the valve remover (E). Put the removed valve insert in a clean place so it does not get dirty.

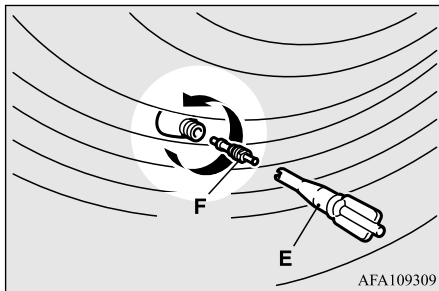

CAUTION

- If there is any air left in the tyre when you remove the valve insert, the valve insert may fly out and injure you. Make sure the tyre contains no air before removing the valve insert.

8. Shake the tyre sealant bottle well.

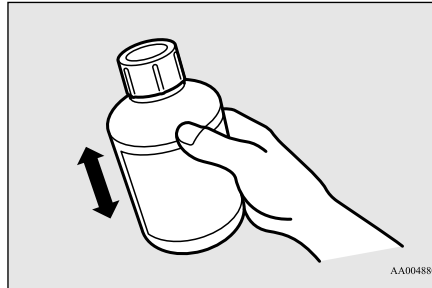

NOTE

- In cold conditions (when the ambient temperature is 0 °C or lower), thickening of the tyre sealant can make the tyre sealant hard to squeeze out of the bottle. Warm the bottle inside the vehicle.

9. Take the cap (G) off the tyre sealant bottle (H). Do not remove the seal (I). Screw the filler hose (J) onto the bottle (H). As you screw the filler hose onto the bottle, the seal will break, allowing the sealant to be used.

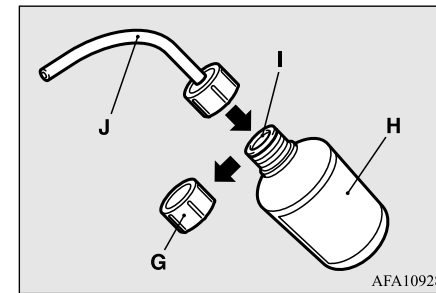

CAUTION

- If you shake the bottle after screwing on the hose, sealant may spray out of the hose.

10. Press the hose onto the valve (D). Holding the sealant bottle upside-down, squeeze it again and again to inject all of the sealant into the tyre.

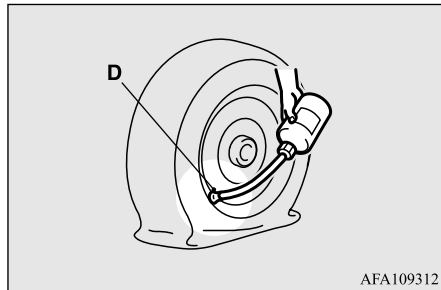

NOTE

- When injecting the sealant, position the valve away from the bottom, i.e., away from the point where the tyre touches the ground. If the valve is near the point where the tyre touches the ground, the sealant may not go into the tyre easily.

11. After injecting the sealant, pull the hose off the valve, remove any residual sealant from the valve, rim and/or tyre. Fit the valve insert (F) into the valve (D), and screw the valve insert securely into place using the valve remover (E).

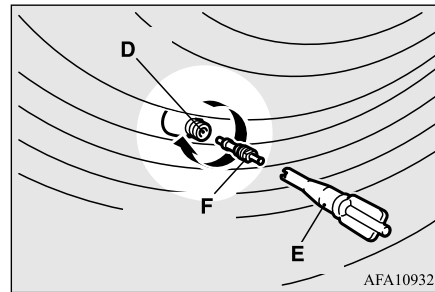

NOTE

- When removing and screwing in the valve insert using the valve remover, turn the valve remover by hand. Using a tool to turn the valve remover could damage it.

12. After injecting the sealant, securely fit the valve remover (E) into the end of the filler hose (J) to prevent sealant from leaking from the empty bottle.

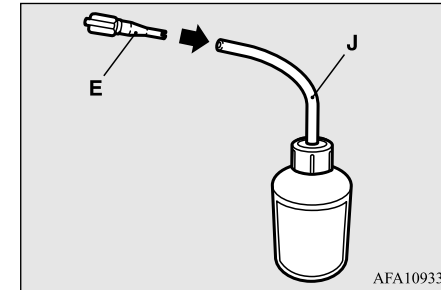

8

13. Pull out the compressor hose (K) from the side of the tyre compressor, and then securely attach the hose to the tyre valve (D).

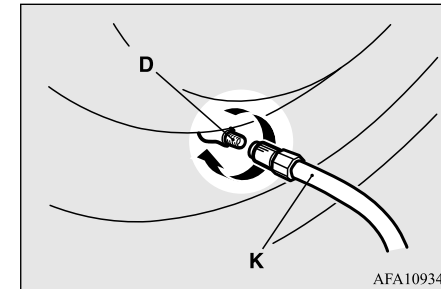

Tyre repair kit

14. Place the compressor (L) with its air pressure gauge (M) on top.

Pull out the compressor's power cord (N), insert the plug on the cord into the accessory socket (O), and then turn the ignition switch to the "ACC" position or put the operation mode in ACC. (Refer to "Accessory socket" on page 7-14.)

Turn ON the compressor switch (P) and inflate the tyre to the specified pressure. (Refer to "Tyre inflation pressures" on page 10-10.)

8

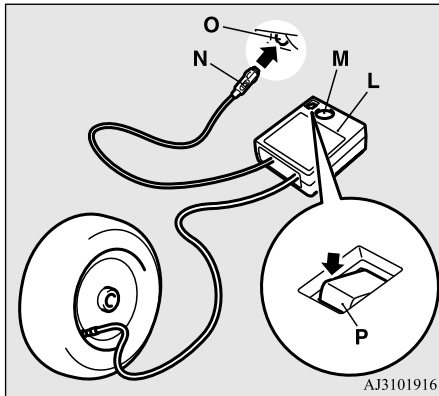

CAUTION

- The supplied compressor is designed only for inflation of your vehicle tyres.

CAUTION

- The compressor is designed to run on a vehicle's 12 V power supply. Do not connect it to any other power source.
- The compressor is not waterproof. If you use it in rain, make sure water does not get on it.
- Any sand or dust sucked into the compressor could make the compressor break down. Do not place the compressor directly on any sandy or dusty surface when using it.
- Do not disassemble or modify the compressor. Also, do not subject the air pressure gauge to shock. It could malfunction.

15. Check and adjust the tyre pressure with reference to the air pressure gauge on the compressor. If you overinflate the tyre, release air by loosening the hose's end fitting.

If there is a gap between the tyre and wheel because the tyre has moved inward from the wheel rim, press the periphery of the tyre towards the wheel to close the gap before running the compressor. (With no gaps, the tyre pressure will rise.)

CAUTION

- Be careful not to get your fingers trapped between the tyre and wheel as the tyre inflates.

CAUTION

- The surface of the compressor will get hot while the compressor is running. Do not keep the compressor running continuously for more than 10 minutes. After using the compressor, wait for the compressor to cool before using it again.
- If the compressor becomes sluggish or hot while operating, it is overheating. Immediately place the switch in the OFF position and let the compressor cool down for at least 30 minutes.

NOTE

- If the tyre pressure does not rise to the specified level within 10 minutes, the tyre may be so severely damaged that the tyre sealant cannot be used to effect an emergency repair. Please contact an authorised MITSUBISHI MOTORS dealer or another specialist in this event.

16. Turn OFF the compressor switch, then pull the power cord plug out of the socket.

NOTE

- Simply putting sealant and air into the tyre using the tyre repair kit does not seal the puncture hole. Air will leak through the puncture hole until the emergency repair procedure is completed (through step 19 or step 20 of these instructions).

17. Affix the speed restriction sticker (Q) to the three-diamond mark on the steering wheel.

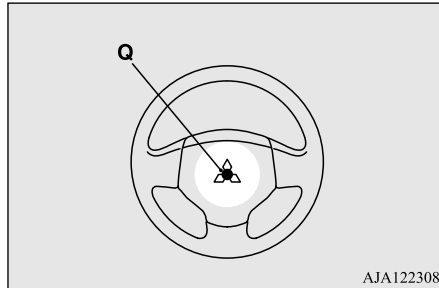

CAUTION

- Do not affix the sticker anywhere except the specified position on the pad of the steering wheel. Affixing the sticker in an incorrect position could prevent the SRS airbag from working normally.

18. When you have inflated the tyre to the specified pressure, stow the compressor, bottle, and other items in the vehicle and promptly start driving the vehicle so that the tyre sealant can spread evenly in the tyre. Drive with great care. Do not exceed a speed of 80 km/h. Observe local speed limits.

CAUTION

- If you sense any abnormality while driving, stop the vehicle and contact an authorised MITSUBISHI MOTORS dealer or another specialist. Otherwise the tyre pressure may drop before the emergency repair procedure is completed, rendering the vehicle unsafe.

NOTE

- Driving faster than 80 km/h can make the vehicle vibrate.

19. After driving for 10 minutes or 5 km, check the tyre pressure using the air pressure gauge on the compressor. If the tyre pressure has apparently not dropped, the emergency repair procedure is complete. Continue the process from step 21. If the tyre pressure is not sufficient, inflate the tyre to the specified pressure again and drive the vehicle carefully without exceeding a speed of 80 km/h.

CAUTION

- If the tyre pressure is lower than the minimum permitted pressure (1.3 bar {130 kPa}), the tyre cannot successfully be repaired with the tyre sealant. Do not drive the vehicle any further. Contact an authorised MITSUBISHI MOTORS dealer or another specialist.

20. After driving for 10 minutes or 5 km, check the tyre pressure using the air pressure gauge on the compressor. If the tyre pressure has apparently not dropped, the emergency repair procedure is complete. You must still not exceed a speed of 80 km/h. Observe local speed limits.

NOTE

- If the tyre pressure has dropped below the specified level when you check it at the end of the repair procedure, do not drive the vehicle any further. Contact an authorised MITSUBISHI MOTORS dealer or another specialist.
- In cold conditions (when the ambient temperature is 0 °C or lower), the time and driving distance necessary until completion of the repair can be longer than in warmer conditions, meaning that the tyre pressure can drop below the specified level even when you have inflated the tyre a second time and subsequently driven the vehicle. If this happens, inflate the tyre to the specified pressure once more, drive for about 10 minutes or 5 km, then check the tyre pressure again. If the tyre pressure has again dropped below the specified level, stop driving the vehicle and contact an authorised MITSUBISHI MOTORS dealer or another specialist.

How to change a tyre

21. Immediately drive with great care to an authorised MITSUBISHI MOTORS dealer and have tyre repair/replacement performed.

CAUTION

- Be sure to check the tyre pressure for confirmation that the emergency repair procedure is complete.

8

NOTE

- Please give the empty sealant bottle to your authorised MITSUBISHI MOTORS dealer when you purchase new sealant or dispose of the sealant bottle according to national regulations for the disposal of chemical waste.
- A tyre in which puncture sealant has been used should ideally be replaced with a new one. If you wish to have such a tyre properly repaired for reuse, please contact an authorised MITSUBISHI MOTORS dealer or another specialist. Note that a proper repair is impossible following an emergency repair if the puncture hole cannot be located.
- The manufacturer is unable to guarantee that all tyre punctures can be repaired with the tyre repair kit, in particular cuts or perforations with a diameter of more than 4 mm or away from the tyre's tread. The manufacturer is not liable for damage sustained through improper use of the tyre repair kit.

NOTE

- The manufacturer is not liable for damage sustained through re-use of any tyre in which tyre sealant has been used.

How to change a tyre

E00801202839

Before changing a tyre, first stop your vehicle in a safe, flat location.

1. Park the vehicle on level and stable ground, free of loose pebbles, etc.
2. Set the parking brake firmly.
3. On vehicles with M/T, stop the engine and move the gearshift lever to the "R" (Reverse) position.
On vehicles with CVT, move the selector lever to the "P" (PARK) position and stop the engine.
4. Turn on the hazard flashers and set up a warning triangle, flashing signal lamp, etc., at an adequate distance from the vehicle, and have all your passengers leave the vehicle.
5. To prevent the vehicle from rolling when jacking up the vehicle, place chocks or blocks (A) at the tyre that is diagonally opposite from the tyre (B) you are changing.

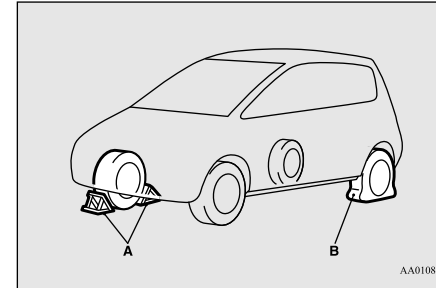

WARNING

- Be sure to apply chocks or blocks to the correct tyre when jacking up the vehicle. If the vehicle moves while jacked up, the jack could slip out of position, leading to an accident.

NOTE

- The chocks shown in the illustration do not come with your vehicle. It is recommended that you keep ones in the vehicle for use if needed.
- If chocks are not available, use stones or any other objects that are large enough to hold the wheel in position.

6. Get the jack, bar and wheel nut wrench ready.
Refer to "Tools and jack" on page 8-5.

To change a tyre

E00803202888

1. On vehicles with wheel covers, first remove the covers (refer to “Wheel covers” on page 8-16). Then loosen the wheel nuts a quarter turn with the wheel nut wrench. Do not remove the wheel nuts yet.

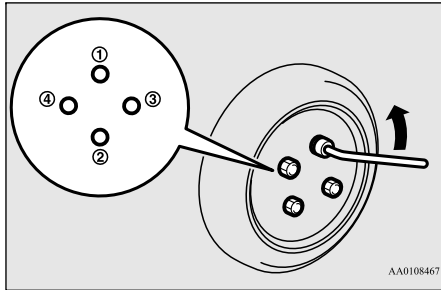

2. Place the jack under one of the jacking points (A) shown in the illustration. Use the jacking point closest to the tyre you wish to change.

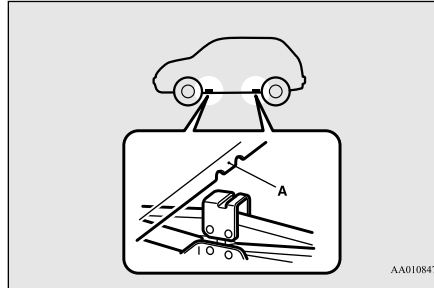

WARNING

- Set the jack only at the positions shown here. If the jack is set at a wrong position, it could dent your vehicle or the jack might fall over and cause personal injury.
- Do not use the jack on a tilted or soft surface. Otherwise, the jack might slip and cause personal injury. Always use the jack on a flat, hard surface. Before setting the jack, make sure there are no sand or pebbles under the jack base.

NOTE

- If you raise the vehicle with a garage jack, refer to “If your vehicle is raised with a garage jack” on page 10-3.

3. Rotate the jack by hand until the flange portion (B) fits in the groove (C) at the top of the jack.

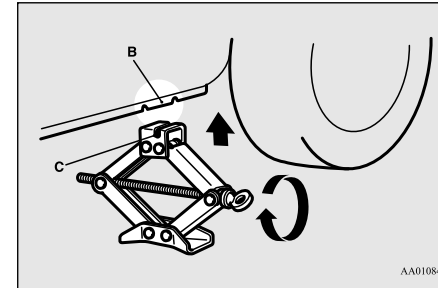

How to change a tyre

4. Insert the bar (D) into the wheel nut wrench (E). Then put the end of the bar into the shaft's jack end, as shown in the illustration.

Slowly rotate the wheel nut wrench until the tyre is raised slightly off the ground surface.

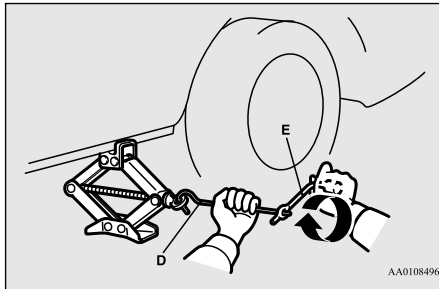

8

WARNING

- Stop jacking up the vehicle as soon as the tyre is raised off the ground. It is dangerous to raise the vehicle any higher.
- Do not get under your vehicle while using the jack.
- Do not bump the raised vehicle or leave it sitting on the jack for a long time. Both are very dangerous.
- Do not use a jack except the one that came with your vehicle.
- The jack should not be used for any purpose other than to change a tyre.

WARNING

- No one should be in your vehicle when using the jack.
- Do not start or run the engine while your vehicle is on the jack.
- Do not turn the raised wheel. The tyres still on the ground could turn and make your vehicle fall off the jack.

5. Remove the wheel nuts with the wheel nut wrench, then take the wheel off.

CAUTION

- Handle the wheel carefully when changing the tyre, to avoid scratching the wheel surface.

6. Clean out any mud, etc. on the hub surface (F), hub bolts (G) or in the installation holes (H) in the wheel, and then mount the spare tyre.

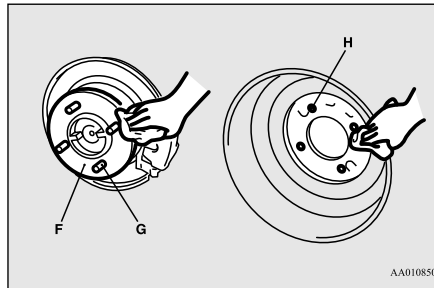

WARNING

- Mount the spare wheel with the valve stem (I) facing outboard. If you cannot see the valve stem (I), you have installed the wheel backwards. Operating the vehicle with the spare wheel installed backwards can cause vehicle damage and result in an accident.

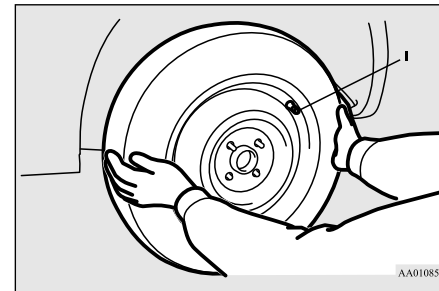

7. Temporarily tighten the wheel nuts by hand until the tapered parts of the wheel nuts make light contact with the seats of the wheel holes and the wheel is not loose.

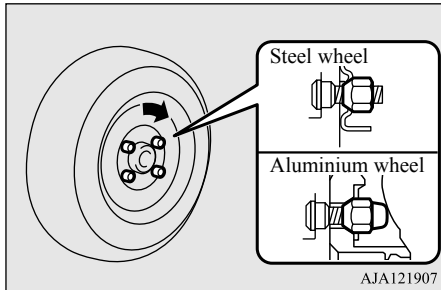

CAUTION

- Never apply oil to either the wheel bolts or the nuts or they will tighten too much.

8. Lower the vehicle slowly by rotating the wheel nut wrench anticlockwise until the tyre touches the ground.

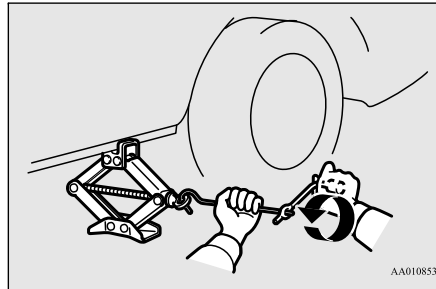

9. Tighten the nuts in the order shown in the illustration until each nut has been tightened to the torque listed here.

Tightening torque
88 to 108 N•m

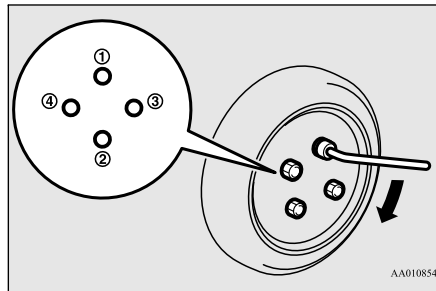

CAUTION

- Never use your foot or a pipe extension for extra force in the wheel nut wrench. If you do so, you will tighten the nut too much.

10. Lower the jack all the way and remove it.
11. Check your tyre inflation pressure at the next gas station. The correct pressures are shown on the driver's door label. See the illustration.

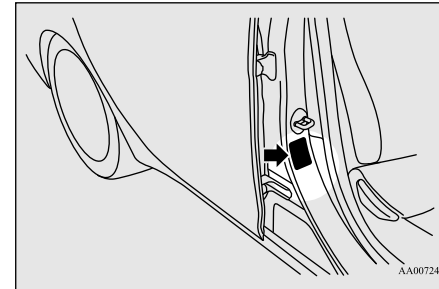

CAUTION

- After changing the tyre and driving the vehicle about 1,000 km, retighten the wheel nuts to make sure that they have not come loose.
- If the steering wheel vibrates when driving after changing the tyre, have the tyre checked for balance at your nearest authorised MITSUBISHI MOTORS dealer.

How to change a tyre

CAUTION

- Do not mix one type of tyre with another or use a different size from the one listed. This would cause early wear and poor handling.

To store the tools and jack

E00803800053

Reverse the removing procedure when storing the jack, bar and wheel nut wrench. Refer to “Tools and jack” on page 8-5.

8

Wheel covers*

E00801301790

To remove

1. Wrap the tip of the jack bar with a cloth, insert it into the notch provided in the wheel cover, and use it to lever up the cover a little.

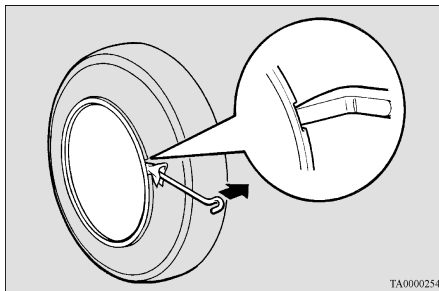

2. With the cover raised a little, pry it off completely using the jack bar. Insert the jack bar under the cover, and move it around the circumference, prying the cover away from the wheel little by little as you move the bar around.

CAUTION

- If you try to use your hands, they may be hurt by the edge of the wheel cover.

NOTE

- The wheel cover is made of plastic; take care when prying it off.

To install

1. Make sure the tabs (A) of the back of the wheel cover are not broken and correctly fitted on the rings (B). If in doubt, do not install the wheel cover and consult your MITSUBISHI MOTORS dealer.

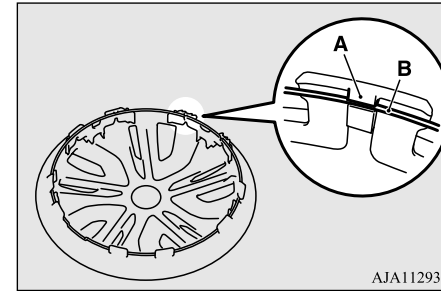

2. Align the air valve (C) of the tyre with the notch (D) in the wheel cover.

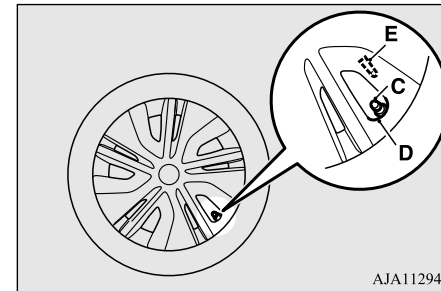

NOTE

- Full wheel covers have a symbol mark (E) provided on the reverse side to show the air valve location.

Before installing the wheel cover to the wheel, make sure that the opening with the symbol mark is correctly aligned with the air valve.

3. Press the bottom part (F) of the wheel cover into the wheel.
4. Gently press both sides (G) of the wheel cover and hold them in place with your knees.
5. Gently tap around the circumference of the wheel cover at the top (H), then press the wheel cover into place.

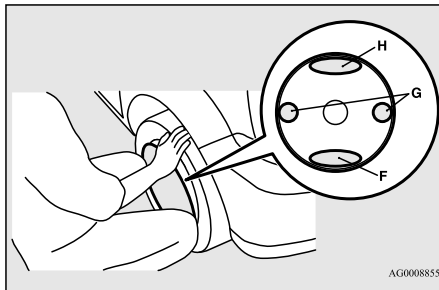

AG0008855

Towing

E00801506612

If your vehicle needs to be towed

If towing is necessary, we recommend you to have it done by your MITSUBISHI MOTORS dealer or a commercial tow truck service.

In the following cases, transport the vehicle using a tow truck.

- The engine runs but the vehicle does not move or abnormal noise is produced.
- Inspection of the vehicle's underside reveals that oil or some other fluid is leaking.

If a wheel gets stuck in a ditch, do not try to tow the vehicle. Please contact your authorised MITSUBISHI MOTORS dealer or a commercial tow truck service for assistance.

Only when you cannot receive a towing service from a MITSUBISHI MOTORS dealer or commercial tow truck service, tow your vehicle carefully in accordance with the instructions given in "Emergency towing" in this part.

The regulations concerning towing may differ from country to country. It is recommended that you obey the regulations of the area where you are driving your vehicle.

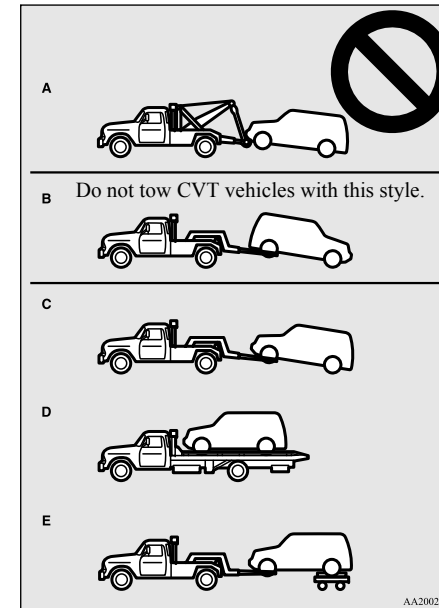

8

Towing the vehicle by a tow truck

⚠ CAUTION

- This vehicle must not be towed by a tow truck using sling lift type equipment (Type A) as illustrated. Using a sling lift will damage the bumper and front end.

Towing

⚠ CAUTION

- Do not tow CVT vehicles with the driving wheels on the ground (Type B) as illustrated. If the vehicle is towed like this, the automatic transmission (CVT) fluid may not reach all parts of the transmission, thus damaging it. If you tow CVT vehicles, use Type C, D or E equipment.
- If the transmission is malfunctioning or damaged, transport the vehicle with the driving wheels on a carriage (Type C, D or E) as illustrated.

8

Towing with rear wheels off the ground (Type B - M/T vehicles only)

Place the gearshift lever in the “Neutral” position.

Turn the ignition switch to the “ACC” position or put the operation mode in ACC and secure the steering wheel in a straight-ahead position with a rope or tie-down strap. Never place the ignition switch in the “LOCK” position or put the operation mode in OFF when towing.

8-18 For emergencies

Towing with front wheels off the ground (Type C)

Release the parking brake.

Place the gearshift lever in the “Neutral” position (M/T) or the selector lever in the “N” (NEUTRAL) position (CVT).

Emergency towing

If towing service is not available in an emergency, your vehicle may be temporarily towed by a rope secured to the towing hook. In case of your vehicle is to be towed by another vehicle, pay careful attention to the following points.

If your vehicle is to be towed forward by another vehicle

1. Take out the towing hook, wheel nut wrench and jack bar. (Refer to “Tools and jack” on page 8-5.)

2. Cover the tip of the jack bar with a cloth, then use it to remove the cover (A) that is located on the front bumper.

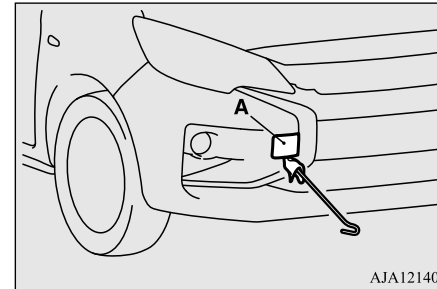

3. Use the wheel nut wrench (B) to securely mount the towing hook (C).

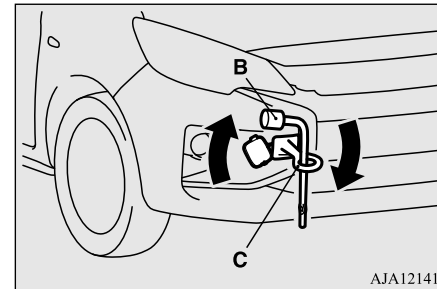

4. Secure the tow rope to the front towing hook.

⚠ CAUTION

- Do not tow the vehicle with the rope at an excessive diagonal angle.

NOTE

- To avoid deforming or otherwise damaging the vehicle body when hooking the rope onto the towing hook, observe the following instructions:
 - Mount the towing hook securely.
 - Do not attach the rope to any part of the vehicle other than the towing hook.
 - Ensure that the towing rope is taut when the towing vehicle moves away.

5. Keep the engine running.
If the engine is not running, perform the following operation to unlock the steering wheel.
[Except for vehicles with the keyless operation system]
On vehicles with M/T, turn the ignition key to the “ACC” or “ON” position.
On vehicles with CVT, turn the ignition key to the “ON” position.
[For vehicles with the keyless operation system]
Put the operation mode in ON.

NOTE

- For vehicles equipped with the Auto Stop & Go (AS&G) system, press the “Auto Stop & Go (AS&G) OFF” switch to deactivate the Auto Stop & Go (AS&G) system before stopping the vehicle.
Refer to “To deactivate” on page 6-24.

WARNING

- **When the engine is not running, the brake booster and power steering system do not operate. This means higher brake depression force and higher steering effort are required. Therefore, vehicle operation is more difficult than usual.**

CAUTION

- Do not leave the key in the “LOCK” position or the operation mode in OFF. The steering wheel will lock, causing loss of control.
- For vehicle equipped with the Forward Collision Mitigation system (Low speed range) (FCM-LS), stop these systems to prevent an unexpected accident or unexpected operation during towing.
Refer to “Forward Collision Mitigation system (Low speed range) (FCM-LS)” on page 6-42.

6. Place the gearshift lever in the “Neutral” position (M/T) or the selector lever in the “N” (NEUTRAL) position (CVT).
7. Turn on the hazard warning lamps if required by law. (Follow the local driving laws and regulations.)
8. During towing make sure that close contact is maintained between the drivers of both vehicles, and that the vehicles travel at low speed.

WARNING

- **Avoid sudden braking, sudden acceleration and sharp turning; such operation could cause damage to the towing hooks or the tow rope. People in the vicinity could be injured as a result.**
- **When towing or being towed down a long slope, the brakes may overheat reducing the effectiveness. In this situation, have your vehicle transported by a tow truck.**

CAUTION

- The person in the vehicle being towed must pay attention to the brake lamps of the towing vehicle and make sure the rope never becomes slack.
- When the vehicle with CVT is to be towed by another vehicle with the all wheels on the ground, make sure that the towing speed and distance given below are never exceeded, causing damage to the transmission.

Towing speed: 40 km/h
Towing distance: 40 km

For the towing speed and the towing distance, follow the local driving laws and regulations.

9. When finished towing, remove the towing hook, and stow it in the specified location. Refer to “Tools and jack” on page 8-5.

Operation under adverse driving conditions

When installing the cover, align the hook with the cut out area on the vehicle, and firmly insert.

If your vehicle is to be towed rearward by another vehicle

If your vehicle is stuck in sand, mud, snow, etc., use the rear towing hook (A) as shown in the illustration.

Secure the tow rope to the rear towing hook.

8

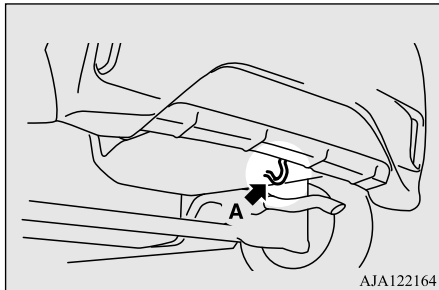

WARNING

- When towing your vehicle out of a stuck position, be sure that the area around the vehicle is clear of people and physical objects.

NOTE

- Using any part other than the designated towing hooks (A) could result in damage to the vehicle body.

Towing another vehicle

Your vehicle cannot be used to tow another vehicle.

Operation under adverse driving conditions

E00801702733

On a flooded road

- Avoid flooded roads. Water could enter the brake discs, resulting in temporarily ineffective brakes. In such cases, lightly depress the brake pedal to see if the brakes operate properly. If they do not, lightly depress the pedal several times while driving in order to dry the brake pads.
- When driving in rain or on a road with many puddles a layer of water may form between the tyres and the road surface. This reduces a tyre's frictional resistance on the road, resulting in loss of steering stability and braking capability.

To cope with this, observe the following items:

- (a) Drive your vehicle at a slow speed.
- (b) Do not drive on worn tyres.
- (c) Always maintain the specified tyre inflation pressures.

On a snow-covered or frozen road

- When driving on a snow-covered or frozen road, it is recommended that you use snow tyres or tyre chains. Refer to the "Snow tyres" and "Tyre chains" sections.
- Avoid high-speed operation, sudden acceleration, abrupt brake application and sharp cornering.

- Depressing the brake pedal during travel on snowy or icy roads may cause tyre slippage and skidding. When traction between the tyres and the road is reduced the wheels may skid and the vehicle cannot readily be brought to a stop by conventional braking techniques. Braking will differ, depending upon whether you have anti-lock brake system (ABS). If you do have ABS, brake by pressing the brake pedal hard, and keeping it pressed. If you do not have ABS, pump the brake pedal with short rapid jabs, each time fully applying and fully releasing for greatest effect.
- Allow extra distance between your vehicle and the vehicle in front of you, and avoid sudden braking.
- Accumulation of ice on the braking system can cause the wheels to lock. Pull away from a standstill slowly after confirming safety around the vehicle.

 **CAUTION**

- Do not press the accelerator pedal rapidly. If the wheels break free of the ice, the vehicle could suddenly start moving and possibly cause an accident.

On a bumpy or rutted road

- Drive as slow as possible when driving on bumpy or rutted roads.

 **CAUTION**

- The impact on tyres and/or wheels when driving on a bumpy or rutted road can damage the tyre and/or wheel.
- The vehicle's body, bumper, muffler and other parts may be damaged if the vehicle is:
 - driven over a step (for example, at the entrance or exit of a parking lot);
 - parked too closely against a kerb or parking block, or by the side of a road with kerbstones;
 - driven on a steep slope.



Vehicle care

Vehicle care precautions9-2
Cleaning the interior of your vehicle9-2
Cleaning the exterior of your vehicle9-3

Vehicle care precautions

Vehicle care precautions

E00900100971

In order to maintain the value of your vehicle, it is necessary to perform regular maintenance using the proper procedures. Always maintain your vehicle in compliance with any environmental pollution control regulations. Carefully select the materials used for washing, etc., to be sure that they do not contain corrosives; if in doubt, contact your authorised MITSUBISHI MOTORS dealer for assistance in the selection of these materials.

9

CAUTION

- Cleaning products can be dangerous. Always follow the instructions of the cleaning product supplier.
- To avoid damage, never use the following to clean your vehicle.
 - Petrol
 - Paint Thinner
 - Benzine
 - Kerosene
 - Turpentine
 - Naphtha
 - Lacquer Thinner
 - Carbon Tetrachloride
 - Nail Polish Remover
 - Acetone

Cleaning the interior of your vehicle

E00900200611

After cleaning the interior of your vehicle with water, cleaner or similar, wipe and dry in a shady, well-ventilated area.

NOTE

- To clean the inside of the tailgate window, always use a soft cloth and wipe the window glass along the demister heater element so as not to cause damage.

CAUTION

- Do not use organic substances (solvents, benzine, kerosene, alcohol, petrol, etc.) or alkaline or acidic solutions. These chemicals can cause discolouring, staining or cracking of the surface. If you use cleaners or polishing agents, make sure their ingredients do not include the substances mentioned above.

Plastic, vinyl leather, fabric and flocked parts

E00900301475

1. Lightly wipe these off with a soft cloth soaked in a mild soap and water solution.

2. Dip cloth in fresh water and wring out well. Using this cloth, wipe off the detergent thoroughly.

NOTE

- Do not use cleaners, conditioners, and protectants containing silicones or wax. Such products can cause discolouring and, when applied to the instrument panels or other parts, may cause reflections on the windscreen and obscure vision. Also, if such products get on the switches of the electrical accessories, it may lead to failure of these accessories.
- The surface of gloss center panel may be scratched if it is rubbed hard by a brush, synthetic fiber or hard cloth.
- Do not use synthetic fiber or dry cloth. They can cause discolouring or damaging the surface.
- Do not place a deodorizer on the instrument panel or near lamps and instruments. The ingredients for deodorizer can cause discolouring or cracking.

Upholstery

E00900500193

1. To maintain the value of your new vehicle, handle the upholstery carefully and keep the interior clean.

Use a vacuum cleaner and brush to clean the seats. If stained, vinyl and synthetic leather should be cleaned with an appropriate cleaner, Cloth fabrics can be cleaned with either upholstery cleaner or a mild soap and water solution.

2. Clean the carpeting with a vacuum cleaner and remove any stains with carpet cleaner. Oil and grease can be removed by lightly dabbing with a clean colourfast cloth and stain remover.

Genuine leather*

E00900600947

1. To clean, lightly wipe the leather with a soft cloth soaked in a mild soap and water solution.
2. Dip cloth in fresh water and wring it out well. Using this cloth, wipe off the detergent thoroughly.
3. Apply leather protecting agent to the genuine leather surface.

NOTE

- If genuine leather is wet with water or is washed in water, wipe off water as quickly as possible with a dry, soft cloth. If left damp, mildew may grow.
- Organic solvents such as benzine, kerosene, alcohol and petrol, acid or alkaline solvents may discolour the genuine leather surface. Be sure to use neutral detergents.

NOTE

- Remove dirty patches or oil substances quickly as they can stain genuine leather.
- The genuine leather surface may harden and shrink if it is exposed to direct rays of the sun for long hours. When your vehicle is parked, place it in the shade as much as possible.
- When the temperature of the vehicle interior rises in summer, vinyl products left on the genuine leather seat may deteriorate and stick to the seat.

Cleaning the exterior of your vehicle

E00900700137

If the following is left on your vehicle, it may cause corrosion, discolouration and stains, wash the vehicle as soon as possible.

- Seawater, road deicing products.
- Soot and dust, iron powder from factories, chemical substance (acids, alkalis, coal-tar, etc.).
- Droppings from birds, carcasses of insects, tree sap, etc.

Washing

E00900903749

Chemicals contained in the dirt and dust picked up from the road surface can damage

Cleaning the exterior of your vehicle

the paint coat and body of your vehicle if left in prolonged contact.

Frequent washing and waxing is the best way to protect your vehicle from this damage. This will also be effective in protecting it from environmental elements such as rain, snow, salt air, etc.

Do not wash the vehicle in direct sunlight. Park the vehicle in the shade and spray it with water to remove dust. Next, using an ample amount of clean water and a car washing brush or sponge, wash the vehicle from top to bottom.

Use a mild car washing soap if necessary. Rinse thoroughly and wipe dry with a soft cloth. After washing the vehicle, carefully clean the joints and flanges of the doors, bonnet, etc., where dirt is likely to remain.

CAUTION

- When washing the under side of your vehicle or wheel, be careful not to injure your hands.
- Refrain from excessively using a car wash as its brushes may scratch the paint surface, causing it to lose its gloss. Scratches will be especially visible on darker coloured vehicles.
- Never spray or splash water on the electrical components in the engine compartment, as this may adversely affect engine starting. Exercise caution also when washing the underbody; be careful not to spray water into the engine compartment.

Cleaning the exterior of your vehicle

9

CAUTION

- Some types of hot water washing equipment apply high pressure and heat to the vehicle. They may cause heat distortion and damage to the vehicle resin parts and may result in flooding of the vehicle interior. Therefore;
 - Maintain a distance of approx. 70 cm or more between the vehicle body and the washing nozzle.
 - When washing around the door glass, hold the nozzle at a distance of more than 70 cm and at right angles to the glass surface.
- After washing the vehicle, drive the vehicle slowly while lightly depressing the brake pedal several times in order to dry out the brakes.
Leaving the brakes wet could result in reduced braking performance. Also, there is a possibility that they could freeze up or become inoperative due to rust, rendering the vehicle unable to move.
- Using an automatic car wash, pay attention to the following items, referring to the operation manual or consulting a car wash operator. If the following procedure is not followed, it could result in damage to your vehicle.
 - The outside rear-view mirrors are retracted.
 - The antenna is removed.
 - The wiper arm assembly is taped.
 - If your vehicle is equipped with a rear spoiler, consult a car wash operator before using the car wash.

CAUTION

- If your vehicle is equipped with the Radar sensing misacceleration Mitigation System (RMS) (Forward), turn the system off by using “Forward Collision Mitigation System (Low speed range) (FCM-LS) and Radar sensing misacceleration Mitigation System (RMS) (Forward) OFF switch” on page 6-48.

During cold weather

The salt and other chemicals spread on the roads in some areas in winter can have a harmful effect on the vehicle body. You should therefore wash the vehicle as often as possible in accordance with our care-instructions. It is recommended to have a preservative applied and the underfloor protection checked at an authorised MITSUBISHI MOTORS dealer before and after the cold weather season.

After washing your vehicle, wipe off all waterdrops from the rubber parts around the doors to prevent the doors from freezing.

NOTE

- To prevent freezing of the weatherstripping on the doors, bonnet, etc., they should be treated with silicone spray.

Waxing

E00901002072

Waxing the vehicle will help prevent the adherence of dust and road chemicals to the paintwork. Apply a wax solution after washing the vehicle, or at least once every 3 months to assist displacing of water.

Do not wax your vehicle in direct sunlight. You should wax after the surfaces have cooled.

For information on how to use wax refer to the instruction manual of the wax.

CAUTION

- Waxes containing high abrasive compounds should not be used.

Polishing

E00901100082

The vehicle should only be polished if the paintwork has become stained or lost its lustre. Matt-finish parts and plastic bumpers must not be polished, polishing these parts will stain them or damage their finish.

Cleaning plastic parts

E00901300794

Use a sponge or chamois leather.

Cleaning the exterior of your vehicle

If a car wax adheres on a grey or black rough surface of the bumper, moulding or lamps, the surface becomes white. In such a case, wipe it off using lukewarm water and soft cloth or chamois leather.

CAUTION

- Do not use a scrubbing brush or other hard tools as they may damage the plastic part surface.
- Do not bring the plastic parts into contact with petrol, light oil, brake fluids, engine oils, greases, paint thinners, and sulphuric acid (battery electrolyte) which may stain, crack or discolour the plastic parts. If they touch the plastic parts wipe them off with soft cloth, chamois or the like and an aqueous solution of neutral detergent then immediately rinse the affected parts with water.

Chrome parts

E00901400128

In order to prevent spots and corrosion of chrome parts, wash with water, dry thoroughly, and apply a special protective coating. This should be done more frequently in winter.

Aluminium wheels*

E00901501748

1. Remove dirt using a sponge while sprinkling water on the wheels.
2. Use neutral detergent on any dirt that cannot be removed easily with water. Rinse off the neutral detergent after washing the wheels.
3. Dry the wheels thoroughly using a chamois leather or a soft cloth.

CAUTION

- Do not use a brush or other hard implement on the wheels. Doing so could scratch the wheels.
- Do not use any cleaner that contains an abrasive substance or is acidic or alkaline. Doing so could cause the coating on the wheels to peel or become discoloured or stained.
- Do not directly apply hot water using a steam cleaner or by any other means.
- Contact with seawater and road deicer can cause corrosion. Rinse off such substances as soon as possible.

Window glass

E00901600120

The window glass can normally be cleaned using only a sponge and water.

Glass cleaner can be used to remove oil, grease, dead insects, etc. After washing the glass, wipe dry with a clean, dry, soft cloth. Never use the same cloth to wipe the window glass as would be used to wipe the paintwork; wax from the painted surfaces could adhere to the glass and reduce its transparency and visibility.

NOTE

- To clean the inside of the tailgate window, always use a soft cloth and wipe the window glass along the demister heater element so as not to cause damage.

Wiper blades

E00901700088

Use a soft cloth and glass cleaner to remove grease, dead insects, etc., from the wiper blades. Replace the wiper blades when they no longer wipe properly. (Refer to page 10-12.)

Engine compartment

E00902101549

Clean the engine compartment at the beginning and end of winter. Pay particular attention to flanges, crevices and peripheral parts where dust containing road chemicals and other corrosive materials might collect.

Cleaning the exterior of your vehicle

If salt and other chemicals are used on the roads in your area, clean the engine compartment at least every 3 months.

Never spray or splash water on the electrical components in the engine compartment, as this may cause damage.

Do not bring the nearby parts, the plastic parts and so on into contact with sulphuric acid (battery electrolyte) which may crack, stain or discolour them.

If they are in contact, wipe off with soft cloth, chamois or the like and an aqueous solution of neutral detergent then immediately rinse the affected parts with plenty of water.

Maintenance

Service precautions	10-2
Catalytic converter	10-3
Bonnet	10-3
Engine oil	10-4
Engine coolant	10-5
Washer fluid	10-7
Brake fluid	10-7
Battery	10-8
Tyres	10-10
Wiper blade rubber replacement	10-12
General maintenance	10-14
For cold and snowy weather	10-15
Fusible links	10-15
Fuses	10-15
Replacement of lamp bulbs	10-20

Service precautions

Service precautions

E01000102481

Adequate care of your vehicle at regular intervals serves to preserve the value and appearance as long as possible.

Some maintenance items can be carried out by the owner (do it yourself), while others should be carried out by an authorised MITSUBISHI MOTORS dealer (periodic inspection and maintenance). In the event a malfunction or a problem is discovered, have it corrected by an authorised MITSUBISHI MOTORS dealer. This section contains information on inspection maintenance procedures that you can do yourself. Follow the instructions and cautions for each of the various procedures.

10

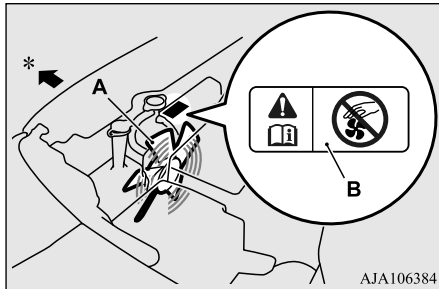

- A- Cooling fan
- B- Caution label
- *: Front of the vehicle

WARNING

- When checking or servicing the inside of the engine compartment, make sure the engine is switched off and has had a chance to cool down.
- If it is necessary to do work in the engine compartment with the engine running, be especially careful that your clothing, hair, etc., does not become caught by the cooling fan, drive belts, or other moving parts.
- After performing the maintenance work, make sure that no tools or cloths are left behind in the engine compartment. If they are left behind, a fire or damage to the vehicle may occur.
- The cooling fan can turn on automatically even if the engine is not running. Turn the ignition switch to the "LOCK" position or put the operation mode in OFF to be safe while you work in the engine compartment.
- Do not smoke, cause sparks or allow open flames around fuel or battery. The fumes are flammable.
- Be extremely cautious when working around the battery. It contains poisonous and corrosive sulphuric acid.
- Do not get under your vehicle with just the body jack supporting it. Always use automotive jack stands.

WARNING

- Improper handling of components and materials used in the vehicle can endanger your personal safety. Consult an authorised MITSUBISHI MOTORS dealer for necessary information.

Check items of engine compartment are located as shown in the figure below.

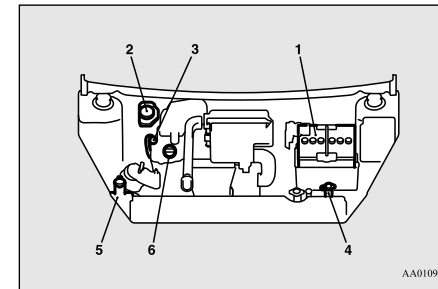

1. Battery
2. Brake fluid reservoir
3. Engine oil level dipstick
4. Engine coolant reservoir
5. Washer fluid reservoir
6. Engine oil cap

If your vehicle is raised with a garage jack

E01011501143

Only use the appointed position as shown in the illustration.

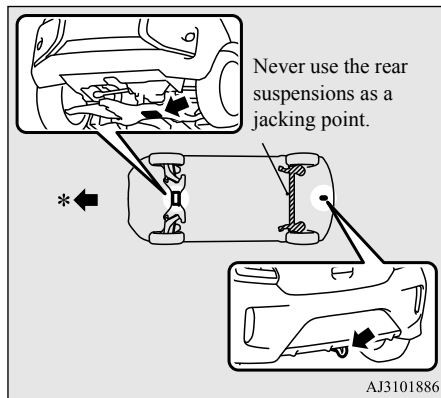

AJ3101886

*- Front of the vehicle

WARNING

- Set the jack only at the positions shown here. If the jack is set at a wrong position, it could damage your vehicle or the jack might fall over and cause personal injury.

WARNING

- Do not use the jack on a tilted or soft surface. Otherwise, the jack might slip and cause personal injury. Always use the jack on a flat, hard surface. Before setting the jack, make sure there are no sand or pebbles under the jack base.

Catalytic converter

E01000202440

The exhaust gas scavenging devices used with catalytic converter are extremely efficient for the reduction of noxious gases. The catalytic converter is installed in the exhaust system.

It is important to keep the engine properly tuned to ensure proper catalyst operation and prevent possible catalyst damage.

WARNING

- As with any vehicle, do not park or operate this vehicle in areas where combustible materials such as dry grass or leaves can come in contact with a hot exhaust since a fire could occur.
- Paint should not be applied to the catalytic converter.

NOTE

- Use fuel of the type recommended in "Fuel selection" on page 2-2.

Bonnet

E01000304852

To open

1. Pull the release lever toward you to unlock the bonnet.

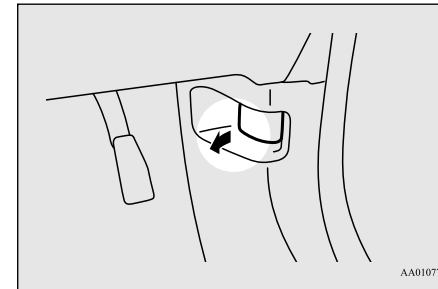

AA0107705

10

Engine oil

2. Raise the bonnet while pressing the safety lock.

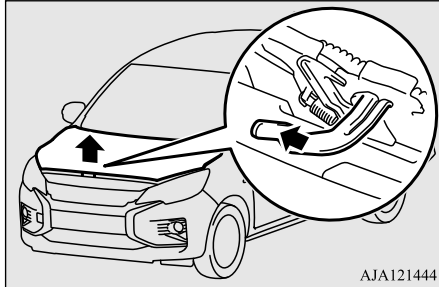

NOTE

- Only open the bonnet when the wipers are in the original position. Failure to do so may cause damage to the bonnet, wiper arms or windscreen.

10

3. Support the bonnet by inserting the support bar in its slot.

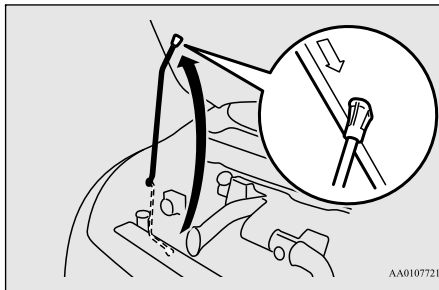

CAUTION

- Note that the support bar may disengage the bonnet if the open bonnet is lifted by a strong wind.
- After inserting the support bar into the slot, make sure the bar supports the bonnet securely from falling down on to your head or body.

To close

1. Unlatch the support bar and clip it in its holder.
2. Slowly lower the bonnet to a position approximately 20 cm above the closed position, then let it drop.
3. Make sure the bonnet is securely locked by softly lifting the centre of the bonnet.

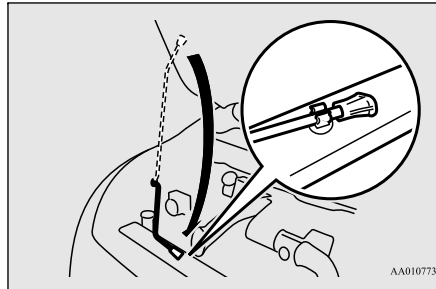

CAUTION

- Be careful that hands or fingers are not trapped when closing the bonnet.
- Before driving, make sure that the bonnet is securely locked. An incompletely locked bonnet can suddenly open while driving. This can be extremely dangerous.

NOTE

- If this does not close the bonnet, release it from a slightly higher position.
- Do not press down the bonnet hard with a hand as it may damage the bonnet.

Engine oil

E01000404996

To check and refill engine oil

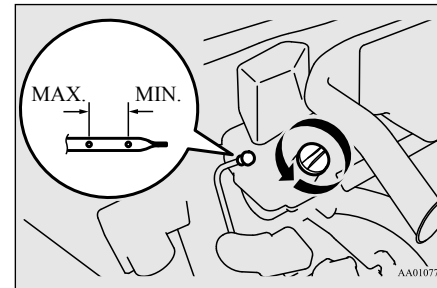

The engine oil used has a significant effect on the engine's performance, service life and startability. Be sure to use oil of the recommended quality and appropriate viscosity. All engines consume a certain amount of oil during normal operation. Therefore, it is important to check the oil level at regular intervals or before starting a long trip.

1. Park the vehicle on a horizontal surface.
2. Switch off the engine.
3. Wait a few minutes.
4. Remove the dipstick and wipe it with a clean cloth.
5. Reinsert the dipstick as far as it goes.
6. Remove the dipstick and read the oil level, which should always be within the range indicated.
7. If the oil level is below the specified limit, remove the cap located on the cylinder head cover and add enough oil to raise the level to within the specified range. Do not overfill to avoid engine damage. Be sure to use the specified engine oil and do not mix various types of oil.
8. After adding oil, close the cap securely.
9. Confirm the oil level by repeating step 4 to 6.

NOTE

- The engine oil will deteriorate rapidly if the vehicle is subjected to severe conditions, requiring earlier oil replacement. Please refer to the maintenance schedule.
- For handling of used engine oils, refer to page 2-5.

Selection of engine oil

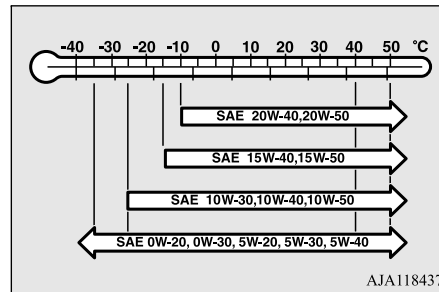

- Select engine oil of the proper SAE viscosity number according to the atmospheric temperature. SAE 0W-20, 0W-30, 5W-20, 5W-30, and 5W-40 engine oils can only be used if they meet ACEA A3/B3, A3/B4 or A5/B5 and API SG (or higher) specifications.
- Use engine oil conforming to the following classification:

- API classification: “For service SG” or higher
- ILSAC certificated oil
- ACEA classification: “For service A1/B1, A3/B3, A3/B4, or A5/B5”

NOTE

- Use of additives is not recommended since they may reduce the effectiveness of additives already included in the engine oil. It may result in failure of the mechanical assembly.

Engine coolant

E01000503307

To check the coolant level

A translucent coolant reservoir (A) is located in the engine compartment. The coolant level in this tank should be kept between the “L” (LOW) and “F” (FULL) marks when measured while the engine is cold.

Engine coolant

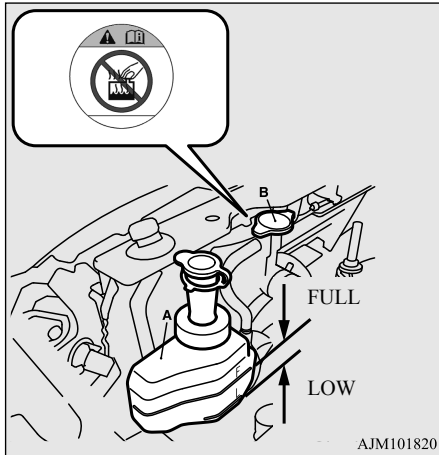

10

To add coolant

The cooling system is a closed system and normally the loss of coolant should be very slight. A noticeable drop in the coolant level could indicate leakage. If this occurs, have the system checked at an authorised MITSUBISHI MOTORS dealer as soon as possible.

If the level should drop below the "L" (LOW) level on the reservoir, open the lid and add coolant.

Also, if the reservoir is completely empty, remove the radiator cap (B) and add coolant until the level reaches the filler neck.

WARNING

- Do not open the radiator cap while the engine is hot. The coolant system is under pressure and any hot coolant escaping could cause severe burns.

Anti-freeze

The engine coolant contains an ethylene glycol anti-corrosion agent. Some parts of the engine are cast aluminium alloy, and periodic changing of the engine coolant is necessary to prevent corrosion of these parts.

Use "MITSUBISHI MOTORS GENUINE SUPER LONG LIFE COOLANT PREMIUM" or equivalent*.

*: similar high quality ethylene glycol based non-silicate, non-amine, non-nitrate and non-borate coolant with long life hybrid organic acid technology

MITSUBISHI MOTORS GENUINE Coolant has excellent protection against corrosion and rust formation of all metals including aluminium and can avoid blockages in the radiator, heater, cylinder head, engine block, etc.

Because of the necessity of this anti-corrosion agent, the coolant must not be replaced with plain water even in summer. The required concentration of anti-freeze differs depending on the expected ambient temperature.

Above -35 °C: 50 % concentration of anti-freeze

Below -35 °C: 60 % concentration of anti-freeze

CAUTION

- Do not use alcohol or methanol anti-freeze or any engine coolants mixed with alcohol or methanol anti-freeze. The use of an improper anti-freeze can cause corrosion of the aluminium components.
- Do not use water to adjust the concentration of coolant.
- Concentrations exceeding 60 % will result in a reduction of both the anti-freeze and cooling performance thus adversely affecting the engine.
- Do not top up with water only.

During cold weather

The concentration should be checked before the start of cold weather and anti-freeze added to the system if necessary to prevent damage to engine and radiator due to freezing.

Washer fluid

E01000702298

Open the washer fluid reservoir cap and check the level of washer fluid.
If the level is low, replenish the container with washer fluid.
Full level is approximately 5 cm below from the upper surface of the reservoir.

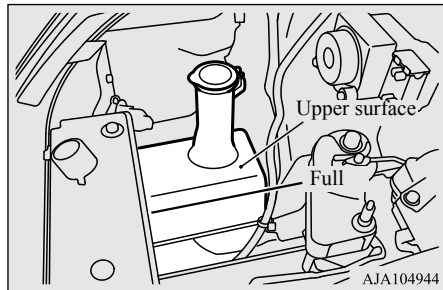

NOTE

- The washer fluid container serves the wind-screen and rear window (if so equipped).

During cold weather

To ensure proper operation of the washers at low temperatures, use a fluid containing an anti-freezing agent.

Brake fluid

E01000902261

To check the fluid level

The fluid level must be between the “MAX” and “MIN” marks on the reservoir.

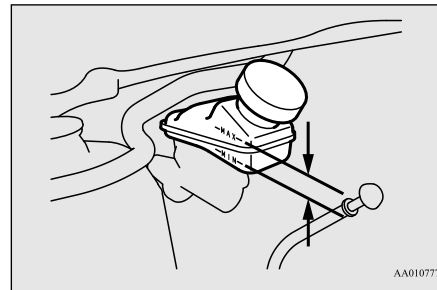

The fluid level is monitored by a float. When the fluid level falls below the “MIN” mark, the brake fluid warning lamp lights up. The fluid level falls slightly with wear of the brake pads, but this does not indicate any abnormality.

If the fluid level falls markedly in a short length of time, it indicates leaks from the brake system.
If this occurs, have the vehicle checked by an authorised MITSUBISHI MOTORS dealer.

Fluid type

Use brake fluid conforming to DOT3 or DOT4 from a sealed container. The brake fluid is hygroscopic. Too much moisture in the brake fluid will adversely affect the brake system, reducing the performance.

WARNING

- Take care in handling brake fluid as it is harmful to the eyes, may irritate your skin and will damage painted surfaces. Wipe up spills immediately.
If brake fluid gets on your hands or in your eyes, flush immediately with clean water. Follow up with a doctor as necessary.

CAUTION

- Use only the specified brake fluid.
Do not mix or add different brand of brake fluid to prevent chemical reaction.
Do not let any petroleum-based fluid touch, mix with, or get into the brake fluid.
This will damage the seals.
- Keep the reservoir cap closed to prevent the brake fluid from deteriorating except maintenance.
- Clean the filler cap before removing and close the cap securely after maintenance.

Battery

Battery

E01001202199

The condition of the battery is very important for quick starting of the engine and proper functioning of the vehicle's electrical system. Regular inspection and care are especially important in cold weather.

Battery precautions

WARNING

- Note operating instructions



When you handle the battery, carefully observe the following cautions for safety.

- No smoking, no naked flames, no sparks



Keep sparks, cigarettes, and flames away from the battery because the battery could explode. Also, do not short-circuit the battery terminals. Doing so could create sparks.

10

WARNING

- Shield eyes



Always wear protective eye goggles when working near the battery. Battery electrolyte contains sulphuric acid, so getting it in your eyes is dangerous.

- Battery acid



Battery electrolyte contains sulphuric acid, so you must wear gloves and eye protection when handling the battery.

If battery electrolyte gets in your eyes or on your skin, rinse it away with clean water and immediately see a doctor.

If you accidentally swallow battery electrolyte, immediately see a doctor.

If battery electrolyte splashes on your clothing or on the vehicle, rinse it off with lots of water.

- Explosive gas



The battery emits highly explosive hydrogen gas. Ventilate when charging the battery in an enclosed space.

WARNING

- Keep away from children



Keep it out of reach of children.

Checking battery electrolyte level

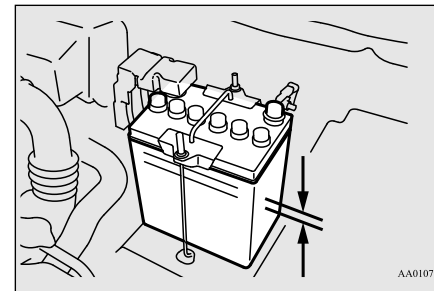

The electrolyte level must be between the specified limit on the outside of the battery. Replenish with distilled water as necessary.

The inside of the battery is divided into several compartments; remove the cap from each compartment and fill to the upper mark. Do not top up beyond the upper mark because spillage during driving could cause damage.

Check the electrolyte level at least once every four weeks, depending on the operating conditions.

If the battery is not used, it will discharge by itself with time. Check it once every four weeks and charge with low current as necessary.

During cold weather

E0101090071

The capacity of the battery is reduced at low temperatures. This is an inevitable result of its chemical and physical properties. This is why a very cold battery, particularly one that is not fully charged, will only deliver a fraction of the starter current which is normally available.

It is recommended that you have the battery checked by an authorised MITSUBISHI MOTORS dealer before the start of cold weather and, if necessary, have it charged.

This does not only ensure reliable starting, but a battery which is kept fully charged also has a longer life.

Disconnection and connection

E01011001308

To disconnect the battery cable, stop the engine, first disconnect the negative (-) terminal and then the positive (+) terminal. When connecting the battery, first connect the posi-

tive (+) terminal and then the negative (-) terminal.

NOTE

- Open the terminal cover (A) before disconnecting or connecting the positive (+) terminal of the battery.
- Loosen the nut (B), and then disconnect the battery cable from the positive (+) terminal.

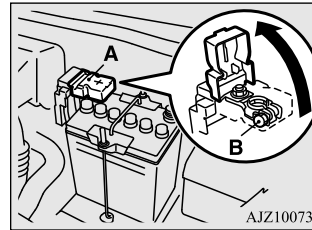

CAUTION

- Never disconnect the battery with the ignition switch or the operation mode in ON; doing so could damage the vehicle's electrical components.
- Never short-circuit the battery; doing so could cause it to overheat and be damaged.
- If the battery is to be quick-charged, first disconnect the battery cables.
- In order to prevent a short circuit, be sure to disconnect the negative (-) terminal first.

CAUTION

- Do not bring the nearby parts, the plastic parts and so on into contact with sulphuric acid (battery electrolyte) which may crack, stain or discolour them. If they are in contact, wipe off with soft cloth, chamois or the like and an aqueous solution of neutral detergent then immediately rinse the affected parts with plenty of water.

NOTE

- Keep the terminals clean. After the battery is connected, apply terminal protection grease. To clean the terminals, use lukewarm water.
- Check to see if the battery is securely installed and cannot be moved during travel. Also check each terminal for tightness.
- When the vehicle is to be left unused for a long period of time, remove the battery and store it in a place where the battery fluid will not freeze. The battery should be stored only in a fully charged condition.

Tyres

Tyres

E01001300301

WARNING

- Driving with tyres that are worn, damaged or improperly inflated can lead to a loss of control or blow out of the tyres which can result in a collision with serious or fatal injury.

Tyre inflation pressures

E01001404821

Tyre size	Front	Rear
165/65R14 79S	2.4 bar (35 psi) [240 kPa]	
175/55R15 77V	2.2 bar (32 psi) [220 kPa]	

10

Check the tyre inflation pressure of all the tyres while they are cold: if insufficient or excessive, adjust to the specified value. After the tyre inflation pressure has been adjusted, check the tyres for damage and air leaks. Be sure to put caps on the valves.

Wheel condition

E01001802049

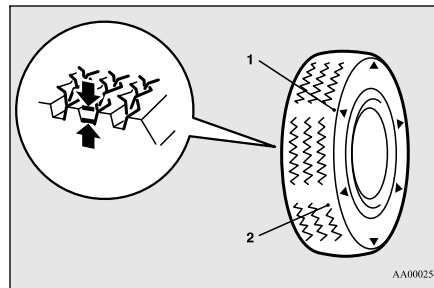

1- Location of the tread wear indicator

2- Tread wear indicator

Check the tyres for cuts, cracks and other damage. Replace the tyres if there are deep cuts or cracks. Also check each tyre for pieces of metal or pebbles.

The use of worn tyres can be very dangerous because of the greater chance of skidding or hydroplaning. The tread depth of the tyres must exceed 1.6 mm in order for the tyres to meet the minimum requirement for use.

Tread wear indicators will appear on the surface of the tyre as the tyre wears, thereby indicating that the tyre no longer meets the minimum requirement for use. When these wear indicators appear, the tyres must be replaced with new ones.

Replacing tyres and wheels

E01007200487

CAUTION

- Avoid using different size tyres from the one listed and the combined use of different types of tyres, as this can affect driving safety. Refer to “Tyres and wheels” on page 11-5.
- Even if a wheel has the same rim size and offset as the specified type of wheel, its shape may prevent it from being fitted correctly. Consult an authorised MITSUBISHI MOTORS dealer before using wheels that you have.

Tyre rotation

E01001902819

Tyre wear varies with vehicle conditions, road surface conditions and individual driver’s driving habits. To equalize the wear and help extend tyre life, it is recommended to rotate the tyres immediately after discovery of abnormal wear, or whenever the wear dif-

ference between the front and rear tyres is recognizable.

When rotating tyres, check for uneven wear and damage. Abnormal wear is usually caused by incorrect tyre pressure, improper wheel alignment, out of balance wheel, or severe braking. Consult your authorised MITSUBISHI MOTORS dealer to determine the cause of irregular tread wear.

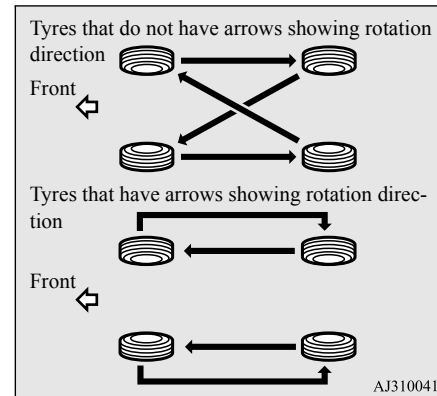

CAUTION

- If the tyres have arrows (A) indicating the correct direction of rotation, swap the front and rear wheels on the left hand side of the vehicle and the front and rear wheels on the right hand side of the vehicle separately. Keep each tyre on its original side of the vehicle. When fitting the tyres, make sure the arrows point in the direction in which the wheels will turn when the vehicle moves forward. Any tyre whose arrow points in the wrong direction will not perform to its full potential.

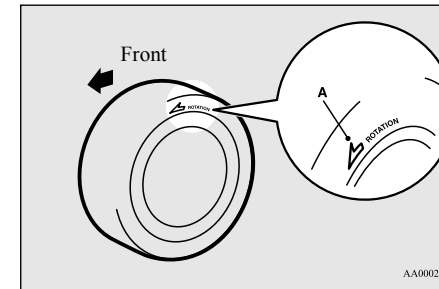

10

CAUTION

- Avoid the combined use of different types of tyres. Using different types of tyres can affect vehicle performance and safety.

Wiper blade rubber replacement

Snow tyres

E01002002110

The use of snow tyres is recommended for driving on snow and ice. To preserve driving stability, mount snow tyres of the same size and tread pattern on all four wheels.

Snow tyres worn more than 50 % are no longer suitable for use as snow tyres.

Snow tyres which do not meet specifications must not be used.

CAUTION

- Observe permissible maximum speed for your snow tyres and the legal speed limit.

10

NOTE

- The laws and regulations concerning snow tyres (driving speed, required use, type, etc.) vary. Find out and follow the laws and regulations in the area you intend to drive.

Tyre chains

E01002103671

It is recommended that snow chains are carried in snow regions and fitted when required to the front wheels.

The tyres fitted to your vehicle as original equipment allow you to fit tyre chains if they are required. When replacing your tyres,

check with the tyre distributor or manufacturer if the fitting of tyre chains will be detrimental to the tyres being purchased.

Always follow the chain manufacturer's instructions when fitting the chains.

CAUTION

- Practice fitting the chains before you need them. Don't expect help from other people in the cold.
- Choose a clear straight stretch of road where you can pull off and still be seen while you are fitting the chains.
- Do not fit chains before you need them. This will wear out your chains and the road surface.
- After driving around 100-300 metres, stop and retighten the chains.
- Drive carefully and do not exceed 30 km/h. Remember, fitting chains is not going to stop accidents from happening.
- When tyre chains are installed, take care that they do not damage the disc wheel or body.
- An aluminium wheel can be damaged by a tyre chain while driving. When fitting a tyre chain on an aluminium wheel, take care that any part of the chain and fitting cannot be brought into contact with the wheel.
- Remove the wheel covers before installing the tyre chains, otherwise they may be damaged by the tyre chains. (Refer to "Wheel covers" on page 8-16.)

CAUTION

- When installing or removing a tyre chain, take care that hands and other parts of your body are not injured by the sharp edges of the vehicle body.
- Install the chains only on the front tyres and tighten them as tightly as possible with the ends securely fastened.

NOTE

- The laws and regulations concerning the use of tyre chains vary. Always follow local laws and regulations.
In most countries, it is prohibited by the law to use of tyre chains on roads without snow.

Wiper blade rubber replacement

E01008201481

Windscreen wiper blades

1. Lift the wiper arm off the windscreen.

Wiper blade rubber replacement

2. Pull the wiper blade until its stopper (A) disengages from the hook (B). Then, pull the wiper blade further to remove it.

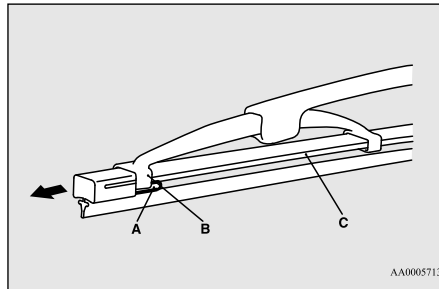

NOTE

- Do not allow the wiper arm to fall onto the windscreen; it could damage the glass.

3. Attach the retainers (C) to a new wiper blade.

Refer to the illustration to ensure that the retainers are correctly aligned as you attach them.

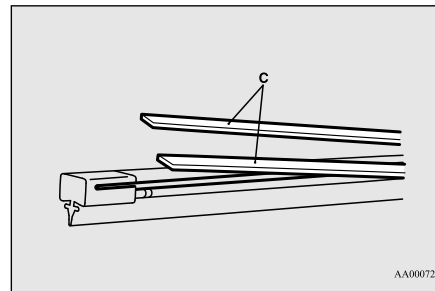

4. Insert the wiper blade into the arm, starting with the opposite end of the blade from the stopper. Make sure the hook (B) is fitted correctly in the grooves in the blade.

NOTE

- If retainers are not supplied with the new wiper blade, use the retainers from the old blade.

5. Push the wiper blade until the hook (B) engages securely with the stopper (A).

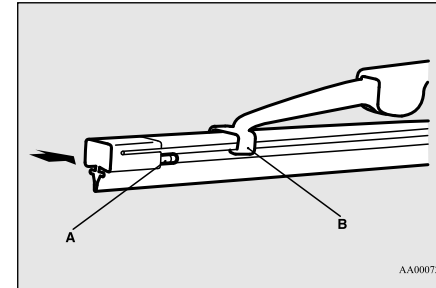

Rear window wiper blades

1. Lift the wiper arm off the window glass.
2. Pull the wiper blade downward to disengage it from the stopper (A) at the end of the wiper arm. Pull the wiper blade further to remove it.

10

General maintenance

3. Slide a new wiper blade through the hook (B) on the wiper arm.

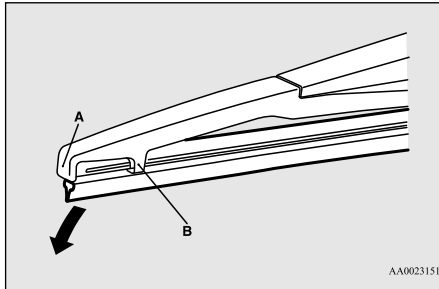

NOTE

- Do not allow the wiper arm to fall onto the window glass; it could damage the glass.

10

4. Firmly insert the retainer (C) into the groove (D) in the wiper blade. Refer to the illustration to ensure that the retainers are correctly aligned as you insert them into the groove.

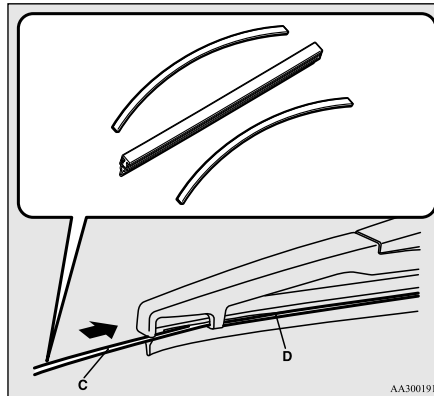

NOTE

- If a retainer is not supplied with the new wiper blade, use the retainer from the old blade.

General maintenance

E01002700546

Fuel, engine coolant, oil and exhaust gas leakage

Look under the body of your vehicle to check for fuel, engine coolant, oil and exhaust gas leaks.

WARNING

- If you see a suspicious fuel leak or if you smell fuel, do not operate the vehicle; call your authorised MITSUBISHI MOTORS dealer for assistance.

Exterior and interior lamp operation

Operate the combination lamp switch to check that all lamps are functioning properly. If the lamps do not illuminate, the probable cause is a blown fuse or defective lamp bulb. Check the fuses first. If there is no blown fuses, check the lamp bulbs.

For information regarding the inspection and replacement of the fuses and the lamp bulbs, refer to "Fuses" on page 10-15 and "Replacement of lamp bulbs" on page 10-20.

If the fuses and bulbs are all OK, take the vehicle to an authorised MITSUBISHI MOTORS dealer for inspection and repair.

Meter, gauge and indicator/warning lamps operation

Run the engine to check the operation of all meters, gauges, and indicator/warning lamps. If there is anything wrong, take the vehicle to an authorised MITSUBISHI MOTORS dealer for inspection.

Hinges and latches lubrication

Check all latches and hinges, and, if necessary, have them lubricated.

For cold and snowy weather

E01002801472

Ventilation slots

The ventilation slots in front of the windscreen should be kept clear of leaves or brushed clear after heavy snowfall, so that the operation of the heating and ventilation systems will not be impaired.

Weatherstripping

To prevent freezing of the weatherstripping on the doors, bonnet, etc., they should be treated with silicone grease.

Additional equipment

It is a good idea to carry a shovel or a short-handled spade in the vehicle during the winter so that you can clear away snow if you get stranded. A small hand-brush for sweeping snow off the vehicle and a plastic scraper for the windscreen and rear window are also useful.

Fusible links

E01002901688

The fusible links will melt to prevent a fire if a large current attempts to flow through certain electrical systems.

In case of a melted fusible link, see your authorised MITSUBISHI MOTORS dealer for inspection and replacement.

For the fusible links, please refer to “Engine compartment fuse location table” on page 10-17.

For cold and snowy weather

WARNING

- Fusible links must not be replaced by any other device. Failing to fit the correct fusible link may result in fire in the vehicle, property destruction and serious or fatal injuries at any time.

Fuses

E01003002289

Fuse block location

To prevent damage to the electrical system due to short-circuiting or overloading, each individual circuit is provided with a fuse. There are fuse blocks in the passenger compartment and in the engine compartment.

10

Passenger compartment

The fuse blocks in the passenger compartment are located behind the glove box at the position shown in the illustration.

No.	Symbol	Electrical system	Capacity
1		Tail lamp (left)	7.5 A
2		Cigarette lighter	15 A
3		Ignition coil	10 A
4		Starter motor	7.5 A
5	—	—	—
6	—	—	—
7		Tail lamp (right)	7.5 A
8		Outside rear-view mirrors	7.5 A
9		Engine control unit	7.5 A
10		Control unit	7.5 A
11		Rear fog lamp	10 A
12		Central door lock	15 A
13		Room lamp	15 A
14		Rear window wiper	15 A
15		Gauge	7.5 A
16		Relay	7.5 A
17		Heated seat	20 A
18	OPTION	Option	10 A

No.	Symbol	Electrical system	Capacity
19		Heated door mirror	7.5 A
20		Windscreen wiper	20 A
21		Reversing lamps	7.5 A
22		Demister	30 A
23		Heater	30 A
24	—	—	—
25		Radio	10 A
26		Electronic controlled unit	15 A

- Some fuses may not be installed on your vehicle, depending on the vehicle model or specifications.
- The table above shows the main equipment corresponding to each fuse.

Engine compartment fuse location table

E01008002646

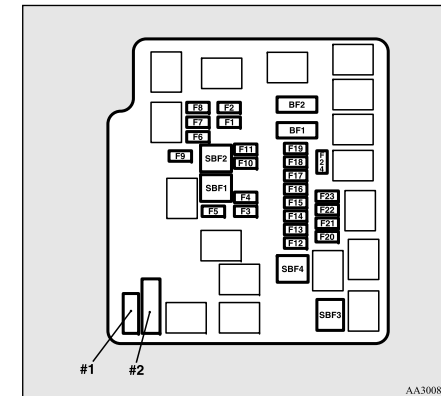



















10

No.	Symbol	Electrical system	Capacities
SBF1		Radiator fan motor	40 A*
SBF2		Anti-lock braking system	30 A*
SBF3		Ignition switch	40 A*
SBF4		Electric window control	40 A*
BF1	A/T	DC-DC (P/T)	30 A

Fuses

10

No.	Symbol	Electrical system	Capacities
BF2		DC-DC (AUDIO)	30 A
F1		Headlamp low beam (left)	10 A
F2		Headlamp low beam (right)	10 A
F3		Headlamp high beam (left)	10 A
F4		Headlamp high beam (right)	10 A
F5		Horn	10 A
F6		Front fog lamps	15 A
F7		Daytime running lamps	10 A
F8	—	—	—
F9	—	—	—
F10		Battery current sensor	7.5 A
F11	—	—	—
F12	STOP	Stop lamps (Brake lamps)	15 A
F13		Ignition coil	7.5 A
F14		Engine control	7.5 A
F15		Alternator	7.5 A

No.	Symbol	Electrical system	Capacities
F16		Hazard warning flasher	10 A
F17	A/T	Automatic transmission	15 A
F18		Air conditioning	10 A
F19		ETV	15 A
F20		Starter	7.5 A
F21	A/T	CVT oil/pump	15 A
F22		Fuel pump	15 A
F23		Engine	20 A
F24	A/T	Automatic transmission	7.5 A
#1	—	Spare fuse	20 A
#2	—	Spare fuse	30 A

*: Fusible link

- Some fuses may not be installed on your vehicle, depending on the vehicle model or specifications.
- The table above shows the main equipment corresponding to each fuse.

The fuse block does not contain spare 7.5 A, 10 A or 15 A fuses. If one of 7.5 A, 10 A or

15 A fuses burns out, substitute with the following fuse.

7.5 A: Outside rear-view mirrors

10 A: Option

15 A: Cigarette lighter

When using a substitute fuse, replace with a fuse of the correct capacity as soon as possible.

Identification of fuse

E01008101480

Capacity	Colour
7.5 A	Brown
10 A	Red
15 A	Blue
20 A	Yellow
30 A	Green (fuse type) / Pink (fusible link type)
40 A	Green (fusible link type)

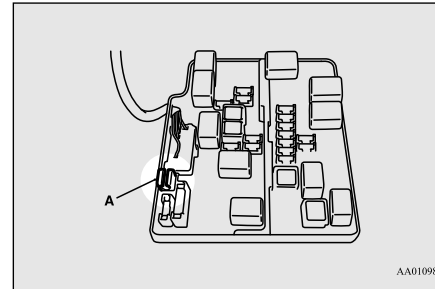

AA0109871

3. Referring to the fuse load capacity table, check the fuse pertaining to the problem.

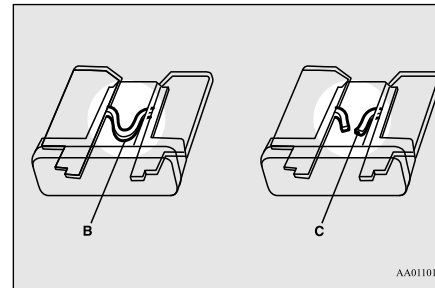

AA0110129

B- Fuse is OK
C- Blown fuse

NOTE

- If any system does not function but the fuse corresponding to that system is normal, there may be a fault in the system elsewhere. Have your vehicle checked by an authorised MITSUBISHI MOTORS dealer.

4. Insert a new fuse of the same capacity by using the fuse puller into the same place at the fuse block.

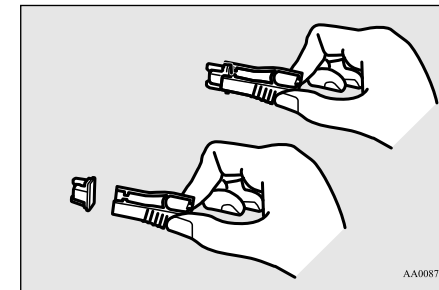

AA0087304

10

Fuse replacement

E01007800832

1. Before replacing a fuse, always turn off the electrical circuit concerned and place the ignition switch in the "LOCK" position or put the operation mode in OFF.
2. Remove the fuse puller (A) from the inside of the fuse block in the engine compartment.

CAUTION

- If the newly inserted fuse blows again after a short time, have the electrical system checked by an authorised MITSUBISHI MOTORS dealer to find the cause and rectify it.
- Never use a fuse with a capacity larger than that specified or any substitute, such as wire, foil, etc.; doing so will cause the circuit wiring to heat up and could cause a fire.

Replacement of lamp bulbs

Replacement of lamp bulbs

E01003102176

Before replacing a bulb, ensure the lamp is off. Do not touch the glass part of the new bulb with your bare fingers; the skin oil left on the glass will evaporate when the bulb gets hot and the vapour will condense on the reflector and dim the surface.

CAUTION

- Bulbs are extremely hot immediately after being turned off. When replacing a bulb, wait for it to cool sufficiently before touching it. You could otherwise be burnt.
- Handle halogen lamp bulb with care. The gas inside halogen lamp bulb is highly pressurized, so dropping, knocking, or scratching a halogen lamp bulb can cause it to shatter.

10

CAUTION

- Never hold the halogen lamp bulb with a bare hand, dirty glove, etc. The oil from your hand could cause the bulb to break the next time the headlamps are operated. If the glass surface is dirty, it must be cleaned with alcohol, paint thinner, etc., and refit it after drying it thoroughly.

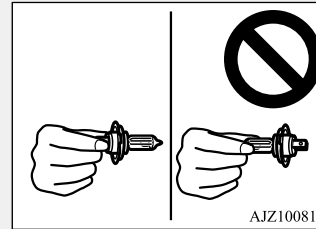

- Do not install commercially available LED-type bulbs. Commercially available LED-type bulbs could adversely affect the operation of the vehicle, such as by preventing the lamps and other vehicle equipment from operating properly.

NOTE

- If you are unsure of how to carry out the work as required, it is recommended that these procedures be carried out by an authorised MITSUBISHI MOTORS dealer.
- Be careful not to scratch the vehicle body when removing a lamp or lens.

NOTE

- When it rains, or when the vehicle has been washed, the inside of the lens sometimes becomes foggy. This is the same phenomenon as when window glass mists up on a humid day, and does not indicate a functional problem. When the lamp is switched on, the heat will remove the fog. However, if water gathers inside the lamp, please go to an authorised MITSUBISHI MOTORS dealer for a check.

Bulb location and capacity

E01003201734

CAUTION

- When replacing a bulb, be sure to use a new bulb of the same type, wattage, and colour. If you install a different bulb, the bulb could malfunction or fail to come on and could lead to a vehicle fire.

Outside

E01003305876

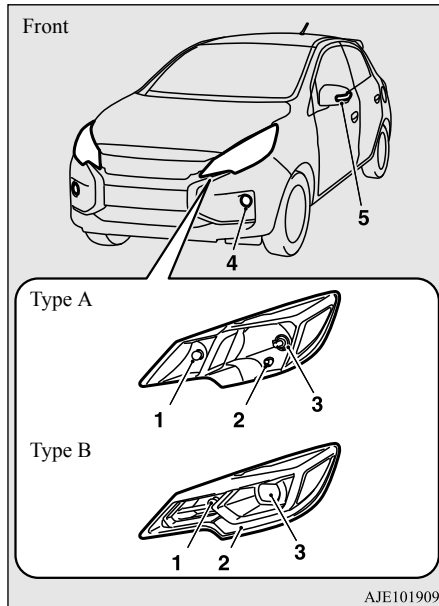

- Type A: Halogen headlamps type
 Type B: LED headlamps type
- 1- Front turn-signal lamps:
21 W (PY21W)
 - 2- Position lamps (Type A): 5 W (W5W)
Position lamps/Daytime running lamps (Type B): –

- 3- Headlamps
Type A: 60/55 W (H4)
Type B: –
- 4- Front fog lamps*: 19 W (H16)
- 5- Side turn-signal lamps: –

Codes in parentheses indicate bulb types.

NOTE

- The following lamps use an LED instead of the bulb.
If you need to repair or replace these lamps, contact an authorised MITSUBISHI MOTORS dealer.
- Headlamps (Type B)
- Position lamps/Daytime running lamps (Type B)
- Side turn-signal lamps

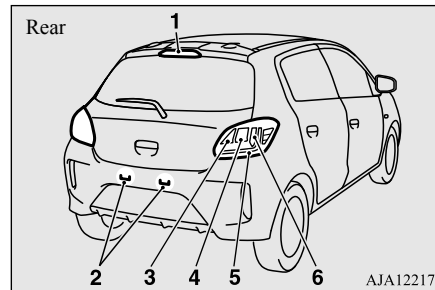

- 1- High-mounted stop lamp (bulb type)*:
5 W (W5W)
- 2- Licence plate lamps: 5 W (W5W)

- 3- Reversing lamps: 16 W (W16W)
- 4- Rear turn-signal lamps:
21 W (PY21W)
- 5- Tail lamps: –
- 6- Stop lamps: –

Codes in parentheses indicate bulb types.

NOTE

- The following lamps use an LED instead of the bulb.
If you need to repair or replace these lamps, contact an authorised MITSUBISHI MOTORS dealer.
- High-mounted stop lamp (on rear spoiler)
- Stop lamps
- Tail lamps

Replacement of lamp bulbs

Inside

E01003404043

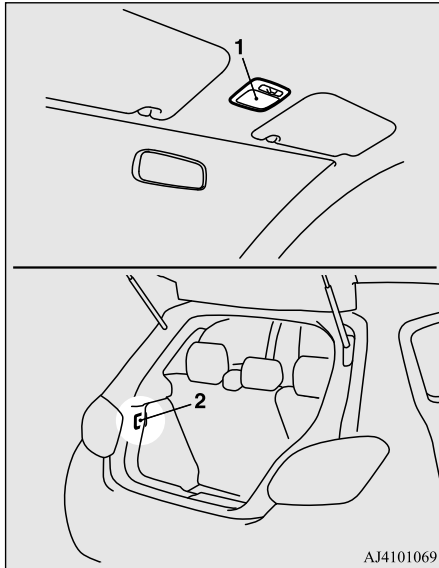

10

- 1- Room lamp: 8 W
- 2- Luggage room lamp: 5 W

AJ4101069

Headlamps (Halogen head-lamps type)

E01009301766

1. Pull out the connector (A), and then remove the sealing cover (B).

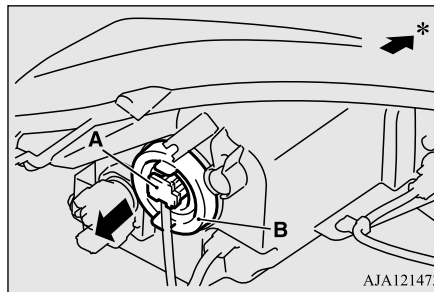

AJA121473

*- Front of the vehicle

2. Unhook the spring (C), which secures the bulb, and then remove the bulb (D).

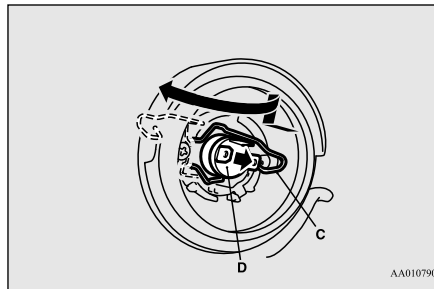

AA0107907

3. To install the bulb, perform the removal steps in reverse.

Position lamps (Halogen head-lamps type)

E01003702781

1. Turn the socket (A) anticlockwise to remove it.

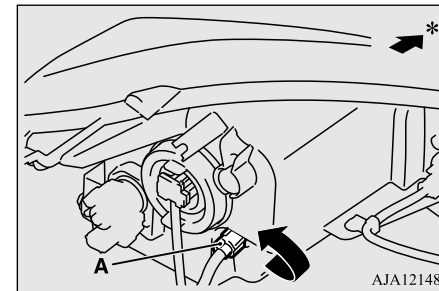

AJA121486

*- Front of the vehicle

2. Pull the bulb out of the socket.

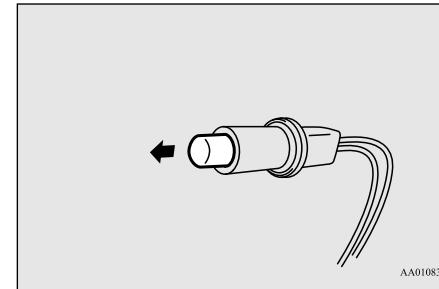

AA0108353

Replacement of lamp bulbs

3. To install the bulb, perform the removal steps in reverse.

Front turn-signal lamps

E01003802737

1. Turn the socket (A) anticlockwise to remove it.

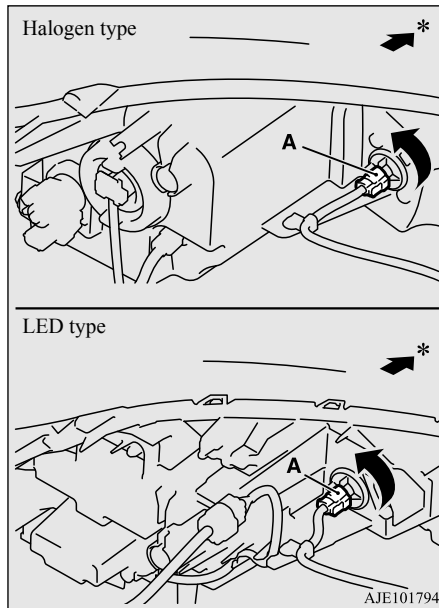

*- Front of the vehicle

2. Remove the bulb from the socket by turning it anticlockwise while pressing in.

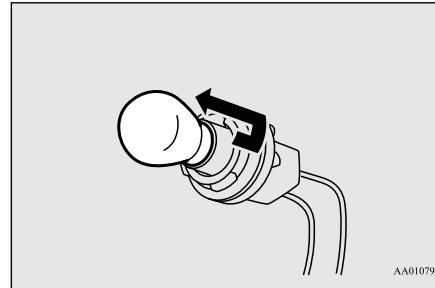

3. To install the bulb, perform the removal steps in reverse.

Front fog lamps*

E01004003892

1. To create enough work space, turn the steering wheel all the way in the direction opposite to the side you wish to replace.

2. Remove the clips (A) to turn up the cover (B).

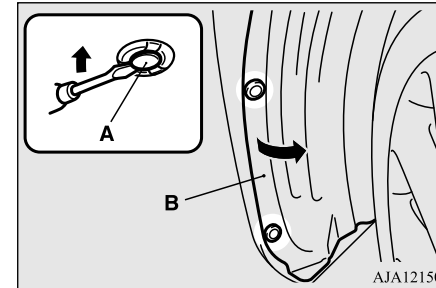

3. While pressing the tab (C), pull out the connector (D).

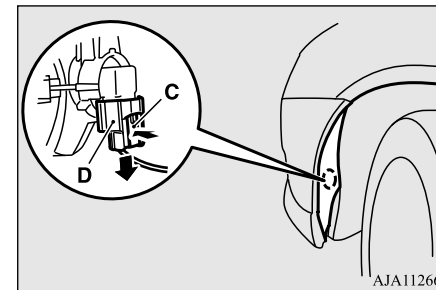

10

Replacement of lamp bulbs

- Turn the bulb (E) anticlockwise to remove it.

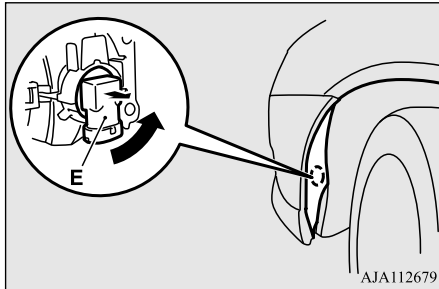

- To install the bulb, perform the removal steps in reverse.

10

NOTE

- When refitting each of the clips, first insert part (F) of the clip into the hole and then press part (G) into it.

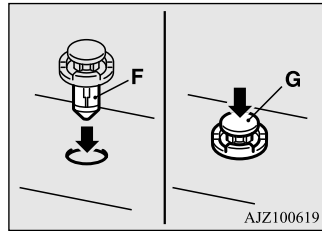

Rear combination lamps

E01004203272

- Open the tailgate
(Refer to "Tailgate" on page 3-17.)
- Remove the screws (A) that hold the lamp unit.

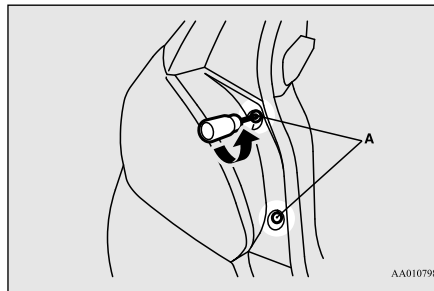

- Move the lamp unit toward the rear of the vehicle to unfix the notch (B) and pin (C).

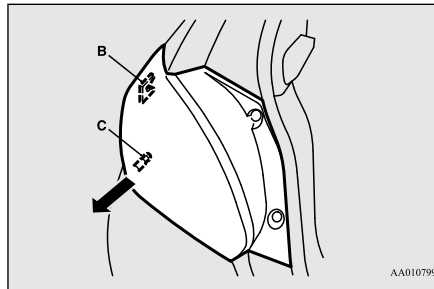

- Turn the socket anticlockwise to remove it.

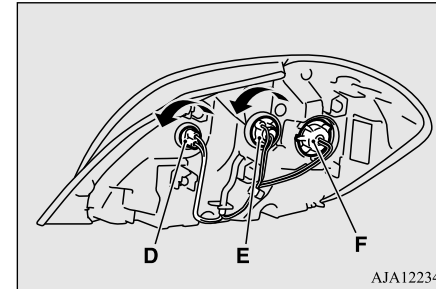

- D- Reversing lamp
- E- Rear turn-signal lamp
- F- Stop lamp and tail lamp - cannot be replaced

NOTE

- The stop lamp and the tail lamp use an LED instead of the bulb.
If you need to repair or replace these lamps, contact an authorised MITSUBISHI MOTORS dealer.

Replacement of lamp bulbs

5. In case of the reversing lamp bulb, remove the bulb from the socket by pulling it out.

In case of the rear turn-signal lamp bulb, remove the bulb from the socket by turning it anticlockwise while pressing in.

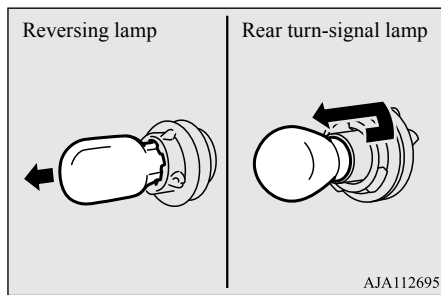

6. To install the bulb, perform the removal steps in reverse.

NOTE

- When mounting the lamp unit, align the notch (G) and pin (H) on the lamp unit with the clip (I) and hole (J) in the body.

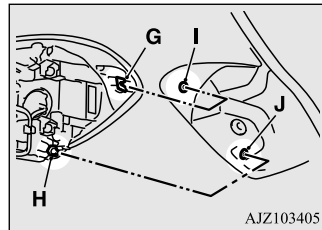

High-mounted stop lamp (bulb type)*

E01004501705

- Open the tailgate.
(Refer to "Tailgate" on page 3-17)
- Insert a straight blade (or minus) screwdriver with a cloth over its tip at the edge of the cover and pry gently to remove the cover (A).

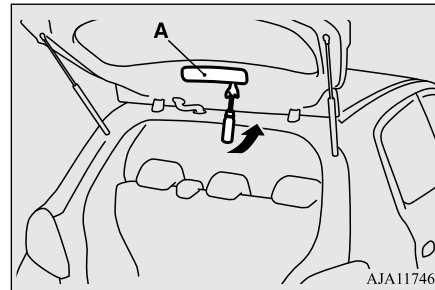

3. Push the four hooks (B) and remove the lamp unit. (Close the tailgate to cause the lamp unit to come out.)

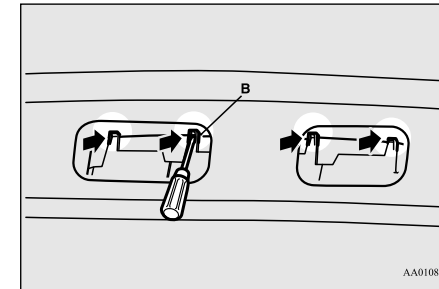

4. Gently close the tailgate, remove the lamp unit, and turn the socket anticlockwise to remove it.

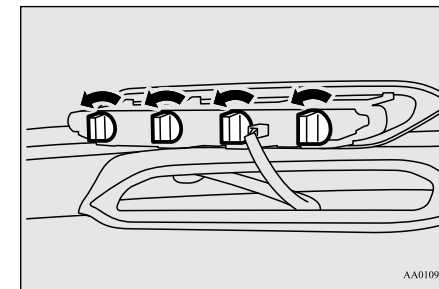

10

Replacement of lamp bulbs

5. Pull the bulb out of the socket.

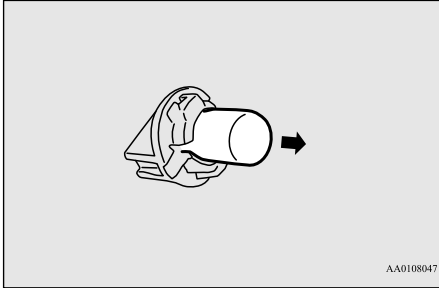

6. To install the bulb, perform the removal steps in reverse.

2. Turn the socket (B) anticlockwise to remove it, and then pull the bulb out from the socket.

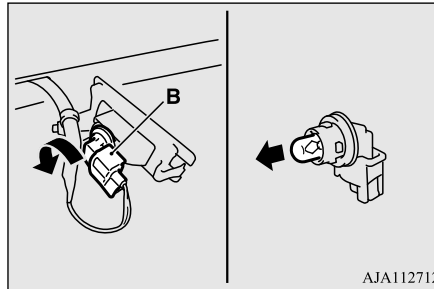

3. To install the bulb, perform the removal steps in reverse.

10

Licence plate lamps

E01004602253

1. Push the lamp unit (A) toward the left side of the vehicle to remove it.

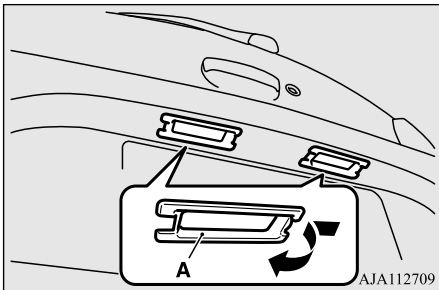

Specifications

Vehicle labeling	11-2
Vehicle dimensions	11-3
Vehicle performance	11-4
Engine specifications	11-5
Electrical system	11-5
Tyres and wheels	11-5
Clutch pedal	11-6
Capacity	11-7

Vehicle labeling

Vehicle labeling

E01100105311

Vehicle identification number

The vehicle identification number is stamped on the bulkhead as shown in the illustration.

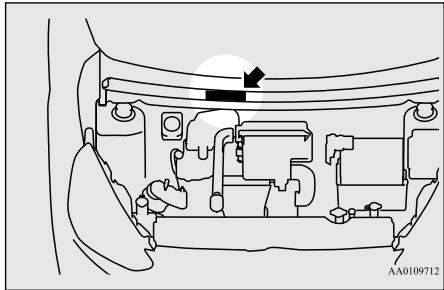

11

Engine model/number

Engine model and number are stamped on the engine cylinder block as shown in the illustration.

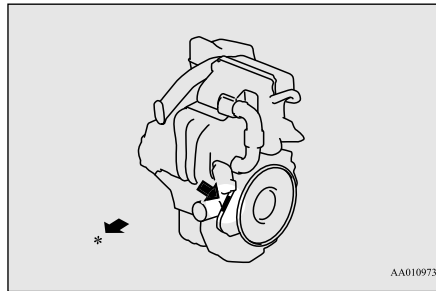

*: Front of the vehicle

Vehicle dimensions

E01100205497

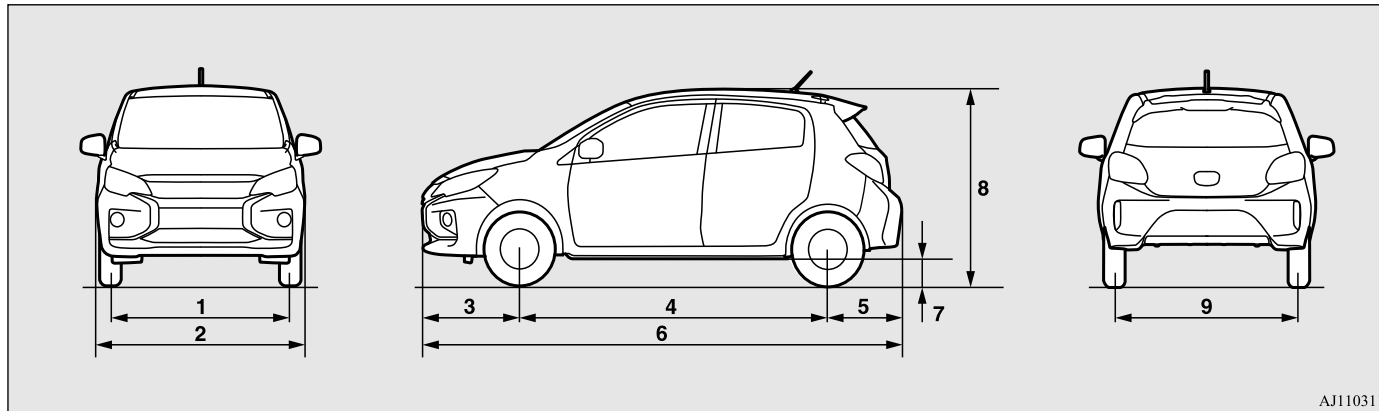

AJ1103118

1	Front track	1,430 mm
2	Overall width	1,665 mm
3	Front overhang	795 mm
4	Wheel base	2,450 mm
5	Rear overhang	600 mm
6	Overall length	3,845 mm
7	Ground clearance (unladen)	150 mm
8	Overall height (unladen)	1,505 mm
9	Rear track	1,415 mm

Vehicle performance

Minimum turning radius

Body	Vehicles with 14 inch tyre	4.8 m
	Vehicles with 15 inch tyre	4.9 m

Wheel	Vehicles with 14 inch tyre	4.4 m
	Vehicles with 15 inch tyre	4.6 m

Vehicle performance

E01100302367

Maximum speed	M/T	170 km/h
	CVT	167 km/h

Engine specifications

E01100604188

Engine model	3A92
No. of cylinders	3 in line
Total displacement	1,193 cc
Bore	75.0 mm
Stroke	90.0 mm
Camshaft	Double overhead
Mixture preparation	Electronic injection
Maximum output (EEC net)	57 kW/6,000 r/min
Maximum torque (EEC net)	100 N•m/4,000 r/min

Electrical system

E01100805132

Voltage	12 V
Battery type	Q-85(D23) (606CCA/118RC)
Alternator capacity	95 A
Spark plug type	NGK DILFR6L11

NOTE

- The vehicles equipped with Auto Stop & Go (AS&G) system have a dedicated AS&G battery type. Use of a different battery could cause the battery to run down quickly or AS&G system not to operate normally. Please contact an authorised MITSUBISHI MOTORS dealer when replacing the battery.

Tyres and wheels

E01100905003

Tyre		165/65R 14 79S	175/55R 15 77V
Wheel	Size	14x4 1/2J	15x5 J
	Offset (Inset)	46 mm	

11

NOTE

- Contact an authorised MITSUBISHI MOTORS dealer for details on the combination used on your vehicle.

Clutch pedal

Clutch pedal

E01102001055

Free play	11 to 16 mm
-----------	-------------

NOTE

- Have the clutch pedal adjusted at an authorised MITSUBISHI MOTORS dealer.

Capacity

E01101308119

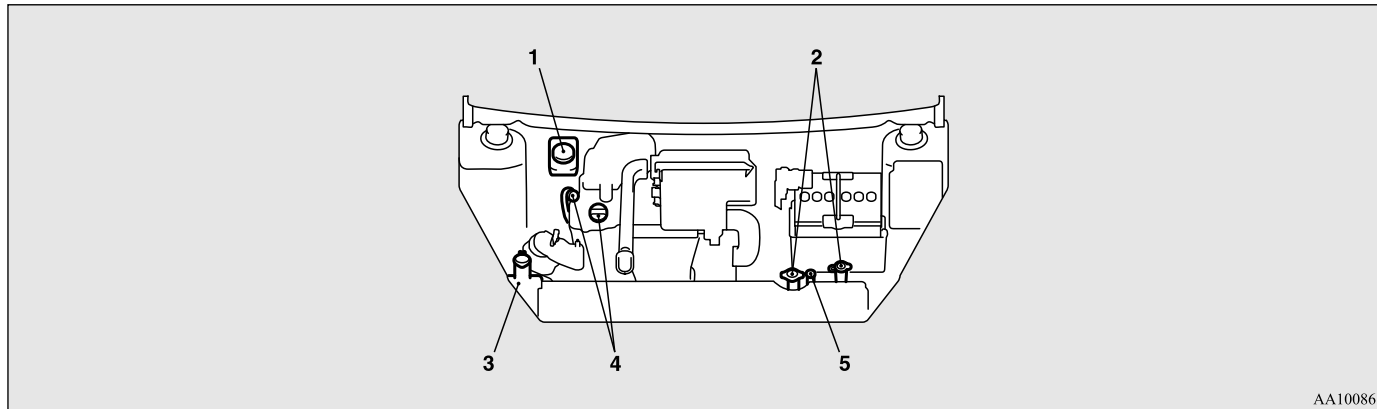

AA1008610

No.	Item		Quantity	Lubricants
1	Brake fluid		As required	Brake fluid DOT3 or DOT4
2	Engine coolant	M/T	3.7 litres* ¹	MITSUBISHI MOTORS GENUINE SUPER LONG LIFE COOLANT PREMIUM or equivalent* ²
		CVT	4.3 litres* ¹	
3	Washer fluid		2.5 litres	—
4	Engine oil	Oil pan	2.8 litres	Refer to page 10-4
		Oil filter	0.2 litre	

11

Capacity

No.	Item	Quantity	Lubricants
5	CVT fluid	7.0 litres	MITSUBISHI MOTORS GENUINE CVTF-J4

⚠ CAUTION

- For the CVT fluid, use only the MITSUBISHI MOTORS GENUINE CVTF.
Use of a different fluid could damage the CVT.

No.	Item	Quantity	Lubricants
6	Manual transmission oil	1.6 litres	MITSUBISHI MOTORS GENUINE NEW MULTI GEAR OIL ECO API GL-4 SAE 75W-80
7	Refrigerant (cooler/air conditioning)	250-290 g	HFC-134a

*1. Includes 0.5 litre in the reservoir

*2. similar high quality ethylene glycol based non-silicate, non-amine, non-nitrate and non-borate coolant with long life hybrid organic acid technology

Information for station service

Fuel	Capacity	35 litres
	Recommended fuel	Unleaded petrol octane number 90 RON or higher Refer to “General information” section for the fuel selection
Engine oil		Refer to the “Maintenance” section for the selection of engine oil.
Tyre inflation pressure		Refer to the “Maintenance” section for the tyre inflation pressure.